

# ANNALES

*Anali za istrske in mediteranske študije*  
*Annali di Studi istriani e mediterranei*  
*Annals for Istrian and Mediterranean Studies*  
*Series Historia Naturalis, 13, 2003, 1*





# ANNALES

*Anali za istrske in mediteranske študije*  
*Annali di Studi istriani e mediterraneei*  
*Annals for Istrian and Mediterranean Studies*  
*Series Historia Naturalis, 13, 2003, 1*



1



2



3



4



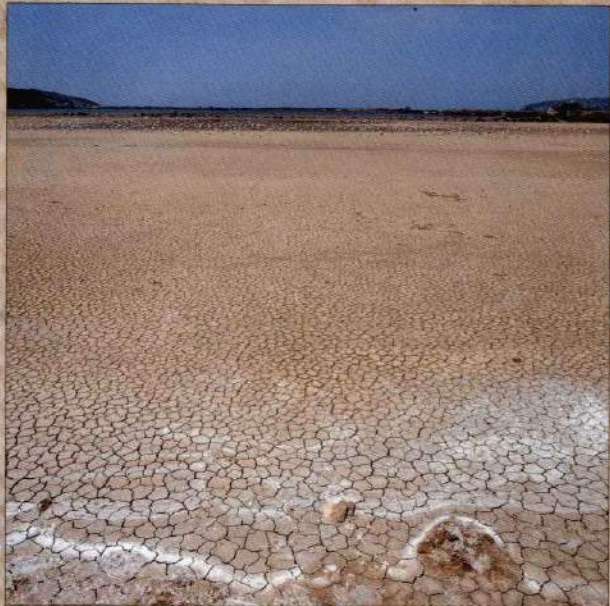

5



6



7

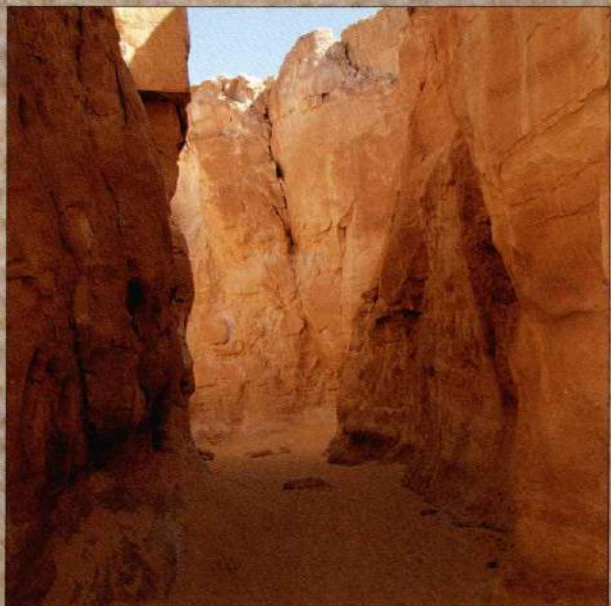

8

  
Banka  
Koper

ISSN 1408-533X



9 771408 533063



# ANNALES



Anali za istrske in mediteranske študije  
Annali di Studi istriani e mediterranei  
Annals for Istrian and Mediterranean Studies

series historia naturalis, 13, 2003, 1

KOPER 2003

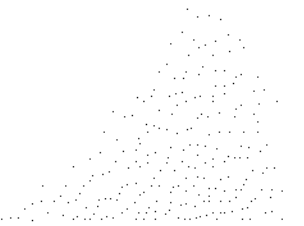



**UREDNIŠKI ODBOR/  
COMITATO DI REDAZIONE/  
BOARD OF EDITORS:** dr. Roderick M. Baxter (SA), dr. Christian Capapé (F), dr. Darko Darovec, dr. Dušan Devetak, dr. Jakov Dulčić (HR), dr. Serena Fonda Umani (IT), dr. Mitja Kaligarič, dr. Andrej Kranjc, dr. Boris Kryštufek, dr. Tom Levanič, dr. Lovrenc Lipej, dr. Alenka Malej, dr. Patricija Mozetič, dr. Darko Ogrin, dr. Livio Poldini (IT), dr. Ehud Spanier (IL), dr. Michael Stachowitsch (A), dr. Davorin Tome, Salvator Žitko, dr. Tone Wraber

**Glavni urednik/Redattore Capo/Managing Editor:** dr. Darko Darovec

**Odgovorni urednik naravoslovja/  
Redattore responsabile per le scienze naturali/  
Natural Science Editor:** dr. Lovrenc Lipej

**Urednica/Redattrice/Editor:** dr. Patricija Mozetič

**Lektorji/Supervisione/Language editors:** Henrik Ciglič (angl./sl.), dr. Michael Stachowitsch (angl.)

**Prevajalci/Traduttori/Translators:** Henrik Ciglič (angl./sl.), Martina Orlando Bonaca (sl./it.)

**Oblikovalec/Progetto grafico/Graphic design:** Dušan Podgornik

**Prelom/Composizione/Typesetting:** Franc Čuden - Medit d.o.o.

**Tisk/Stampa/Print:** Grafis trade d.o.o.

**Izdajatelj/Editori/Published by:** Zgodovinsko društvo za južno Primorsko/Società storica del Litorale © - Znanstveno raziskovalno središče Republike Slovenije, Koper/Centro di ricerche scientifiche della Repubblica di Slovenia, Capodistria/Science and Research Centre of the Republic of Slovenia, Koper ©

**Za izdajatelja/Per gli Editori/  
Publishers represented by:** Salvator Žitko, dr. Darko Darovec  
Znanstveno raziskovalno središče Republike Slovenije,  
Koper, SI-6000 Koper/Capodistria, Garibaldijska 18/  
Via Garibaldi 18, p.p. /P.O. Box 612, tel.: + 386 5 6637700,  
fax: + 386 5 6637710;  
**e-mail:** annales@zrs-kp.si, **internet:** http://www.zrs-kp.si/

Ponatis člankov in slik je mogoč samo z dovoljenjem uredništva in navedbo vira.

Redakcija te številke je bila zaključena 10. oktobra 2003

**Sofinancirajo/Supporto finanziario/  
Financially supported by:** Ministrstvo za šolstvo, znanost in šport Republike Slovenije,  
Ministrstvo za kulturo Republike Slovenije, Mestna občina Koper, Občina Izola, Občina Piran, Banka Koper ter drugi sponzorji

Annales - series historia naturalis izhaja dvakrat letno.

Annales - series historia et sociologia izhaja dvakrat letno.

Letna naročnina za obe seriji je 7000 SIT, maloprodajna cena tega zvezka je 2500 SIT.

Nenaročenih rokopisov in drugega gradiva ne vračamo. Rokopise in naročnino sprejemamo na sedežu uredništva.  
Rokopise lahko pošiljate tudi članom uredništva.

**Naklada/Tiratura/Circulation:** 700 izvodov

Revija Annales series historia naturalis je vključena v naslednje podatkovne baze: BIOSIS-Zoological Record (UK), Aquatic Sciences and Fisheries Abstracts (ASFA).

## VSEBINA / INDICE GENERALE / CONTENTS

IHTIOLOGIJA  
ITTILOGIA  
ICHTHYOLOGY**Hakan Kabasakal**

Historical and contemporary records of sharks from the Sea of Marmara, Turkey ..... 1  
*Starejši in novejši podatki o pojavljanju morskih psov v Marmarskem morju, Turčija*

**Christian Capapé, Farid Hemida, Jalil Bensaci, Béchir Saïdi & Mohamed Nejmeddine Bradaï**

Records of basking sharks, *Cetorhinus maximus* (Gunnerus, 1765) (Chondrichthyes: Cetorhinidae) off the Maghreb shore (southern Mediterranean): a survey ..... 13  
*Pojavljanje morskega psa orjaka, Cetorhinus maximus (Gunnerus, 1765) (Chondrichthyes: Cetorhinidae), v bližini Maghrebskega obrežja (južno Sredozemlje): pregled*

**Jakov Dulčić, Armin Pallaoro & Sanja Matić**

On the record of Madeira rockfish *Scorpaena madurensis Valenciennes*, 1833, in the eastern Adriatic ..... 19  
*O vrsti Scorpaena madurensis Valenciennes, 1833, ujeti v vzhodnem Jadranu*

MORSKA BIOLOGIJA IN EKOLOGIJA  
BIOLOGIA ED ECOLOGIA MARINA  
MARINE BIOLOGY AND ECOLOGY**Barbara Sladonja, Ivana Maguire, Radovan Erben, Goran Klobučar & Jasna Lajtner**

Estimating the carrying capacity of coastal areas potentially suitable for mussel culture in the upper Adriatic, Croatia ..... 25  
*Ocenjevanje nosilnosti okolja v severnojadranskih obalnih območjih, potencialno primernih za vzgojo školjk*

**Boruš Vrišer**

Meiobenthic fauna (without Harpacticoida) in the southern part of the Gulf of Trieste: List of taxa ..... 33  
*Meiobentoška favna (brez harpaktikoidov) južnega dela Tržaškega zaliva: seznam vrst*

**Marco Bianchini, Ehud Spanier & Sergio Ragonese**

Enzymatic variability of Mediterranean Slipper Lobsters *Scyllarides latus*, from Sicilian waters ..... 43  
*Encimatska variabilnost velikega nagajivca, Scyllarides latus, v sicilijanskih vodah*

**Marco Affronte, Leandro Augusto Stanzani & Giacomo Stanzani**

First record of the humpback whale, *Megaptera novaeangliae* (Borowski, 1781), from the Adriatic Sea ..... 51  
*Prvi zapis o kitu grbavcu Megaptera novaeangliae (Borowski, 1781) in the Adriatic Sea*

KLIMATSKE SPREMENBE  
VARIAZIONI CLIMATICHE  
CLIMATE CHANGES**Zalika Črepinšek & Lučka Kajfež-Bogataj**

Spring phenological trends in Slovenia ..... 57  
*Trendi pomladanskih fenofaz v Sloveniji*

**Darko Ogrin**

Suha in mokra leta v submediteranski Sloveniji od 14. do srede 19. stoletja ..... 65  
*Dry and wet years in Submediterranean Slovenia from the 14<sup>th</sup> to the mid-19<sup>th</sup> centuries*

RAZISKAVE SLADKIH VODA  
RICERCHE DI ACQUE DOLCI  
FRESHWATER RESEARCH**Janos Nagy & Zoltan Tuba**

A preliminary report on a new type of floating myre from Hungary ..... 77  
*Preliminarno poročilo o novem tipu "zavesastega" barja na Madžarskem*

**Aleksandra Krivograd Klemenčič, Danijel Vrhovšek & Gorazd Kosí**

Algae in Dragonja river ..... 83  
*Alge v reki Dragonji*



**Janja Kogovšek, Sonja Diković, Metka Petrič,  
Josip Rubinić, Martin Knez, Elza Hrvojić  
& Tadej Slabe**  
Hydrochemical research of the Mlini  
springs, Istria ..... 91  
*Hidrokemične raziskave izvira Mlini, Istra*

**Gregor Muri & Saša Eržen**  
Relations between air temperature, precipitation  
and surface and vertical water temperature  
variations in the three Kriško lakes (Julian Alps,  
NW Slovenia) in July 2002 ..... 103  
*Odnos med temperaturo zraka, padavinami ter  
nihanjem površinske in globinske temperature  
vode v treh Kriških jezerih (Julijske Alpe, SZ  
Slovenija) v juliju 2002*

**Gregor Kovačič**  
Kraški izviri Bistrice (JZ Slovenija) ..... 111  
*Bistrica karst springs (SW Slovenia)*

DELO NAŠIH ZAVODOV IN DRUŠTEV  
ATTIVITÀ DEI NOSTRI ISTITUTI E DELLE  
NOSTRE SOCIETÀ  
ACTIVITIES BY OUR INSTITUTIONS AND  
ASSOCIATIONS

**Slavko Mezek, Bogdan Macarol & Mitja Bricelj**  
Mednarodna delavnica "Ekoremediacije v  
celostnem upravljanju z vodami v Sredozemlju" .. 123

**Robert Turk, Valter Žiža & Tihomir Makovec**  
Ohranimo želvo v slovenskem morju ..... 128

OCENE IN POROČILA  
RECENSIONI E RELAZIONI  
REVIEWS AND REPORTS

Boris Sket, Matija Gogala, Valika Kuštor (ur.):  
Živalstvo Slovenije (**Davorin Tome**) ..... 126

Andrej Gogala: Kamen, voda,  
sonce in veter. Narava Krasa in Slovenske  
Istre (**Mitja Kaligarič**) ..... 127

Ivan Gams: Kras v Sloveniji v prostoru  
in času (**Nataša Režek Donev**) ..... 128

Kazalo k slikam na ovitku ..... 130  
*Index to pictures on the cover* ..... 130

Navodila avtorjem ..... 131  
*Instructions to authors* ..... 133

IHTIOLOGIJA

ITTIOLOGIA

ICHTHYOLOGY



## HISTORICAL AND CONTEMPORARY RECORDS OF SHARKS FROM THE SEA OF MARMARA, TURKEY

Hakan KABASAKAL

Ichthyological Research Society, Atatürk Mahallesi, Menteşoğlu Caddesi, İdil apt., No 30, D 4, TR-34764 Ümraniye, İstanbul  
E-mail: hakankabasakal@hotmail.com

### ABSTRACT

Twenty species of sharks, with either confirmed or questionable presence in the Sea of Marmara, comprise nearly the 8 % of the total ichthyofauna of Marmaric waters. Regarding their species numbers, squaliform and carcharhini-form sharks, each represented by 7 species, dominated the species composition of sharks in Marmaric waters. Squaliform sharks, scyliorhinid *Galeus melastomus*, and adult individuals of *Hexanchus griseus*, have been mostly captured over the deeper parts of shelf and upper slope on the northern side, while *Mustelus asterias* and *M. mustelus*, and scyliorhinids, *Scyliorhinus canicula* and *S. stellaris*, as well as the young individuals of *H. griseus*; and *Squatina squatina* have been mostly captured in the southern part of Marmara. *Alopias vulpinus* is the only pelagic species recorded in the present research. The current presence of 5 species, *Carcharodon carcharias*, *Lamna nasus*, *Galeorhinus galeus*, *Prionace glauca* and *Echinorhinus brucus*, is questionable, and for the time being it is not possible to say whether their Mediterranean distribution still extends to Marmaric waters. Southern part of the Sea of Marmara appears a suitable shark nursery, in particular for scyliorhinid and triakid species.

**Key words:** sharks, distribution, shark bycatches, shark nurseries, Sea of Marmara

## SEGNALAZIONI STORICHE E CONTEMPORANEE DI SQUALI NEL MAR DI MARMARA, TURCHIA

### SINTESI

Venti specie di squali, sia che la loro presenza sia confermata o dubbia nel Mar di Marmara, costituiscono quasi l'otto per cento dell'ittiofauna totale di tali acque. Per quanto riguarda squali squaliformi e carcariniformi, ognuno di essi rappresentato da sette specie, essi dominano la composizione di specie di squali in acque marmariche. Squali squaliformi, il boccanera *Galeus melastomus*, e individui adulti dello squalo capopiatto *Hexanchus griseus*, sono stati catturati principalmente nelle parti più profonde del piano e del pendio superiore nella parte settentrionale, mentre *Mustelus asterias* e *M. mustelus*, gli sciliorinidi *Scyliorhinus canicula* e *S. stellaris*, giovani individui di *H. griseus*, nonché *Squatina squatina*, sono stati catturati principalmente nella parte meridionale di Marmara. *Alopias vulpinus* è l'unica specie pelagica riscontrata nella presente ricerca. La presenza di 5 specie, *Carcharodon carcharias*, *Lamna nasus*, *Galeorhinus galeus*, *Prionace glauca* e *Echinorhinus brucus*, risulta dubbia, pertanto non è per il momento possibile ipotizzare un ampliamento della loro distribuzione mediterranea anche al Mar di Marmara. La parte meridionale del Mar di Marmara appare idonea alla funzione di nursery, soprattutto per sciliorinidi e triachidi.

**Parole chiave:** squali, distribuzione, catture di squali, nursery per squali, Mar di Marmara



## INTRODUCTION

Although the origin of the ichthyological studies in the Sea of Marmara dates back to nearly a century (see Bilecenoğlu *et al.*, 2002, for review), very few specific studies on sharks of this unique inland sea have been produced to date. Our knowledge about sharks of the Sea of Marmara is limited to the general ichthyological works (Ninni, 1923 [in Bilecenoğlu *et al.*, 2002]; Devedjian, 1926; Ayaşlı, 1937; Erazî, 1942; Akşiray, 1987; Bauchot, 1987; Kocataş *et al.*, 1993; Meriç, 1995; Mater & Meriç, 1996), or to a few specific studies on sharks of this sea (Benli *et al.*, 1993; Okuş *et al.*, 1996; Uysal *et al.*, 1996; Kabasakal, 1998). According to the most recent list of elasmobranch species of the seas of Turkey, 15 confirmed and one questionable species of sharks are present in the Sea of Marmara (Kabasakal, 2002), while the presence of another 4 species of sharks, *Galeorhinus galeus*, *Prionace glauca*, *Echinorhinus brucus* and *Squatina oculata*, from Marmaric waters have also been reported in some pioneering works and in a single recent ichthyological work dealing with

Turkish seas (Ninni, 1923 [Bilecenoğlu *et al.*, 2002]; Devedjian, 1926; Ayaşlı, 1937; Meriç, 1994 [in Bilecenoğlu *et al.*, 2002]). With the exception of *S. oculata*, whose presence was described in a recent report (Meriç, 1994 [Bilecenoğlu *et al.*, 2002]), the status of the remaining 3 species, *G. galeus*, *P. glauca* and *E. brucus*, is uncertain and regarding their presence in the Sea of Marmara (Ninni, 1923 [Bilecenoğlu *et al.*, 2002]; Devedjian, 1926; Ayaşlı, 1937), it would be proper to consider them as "doubtful species".

The main objective of the present work is to provide information on the basis of a number of historical and contemporary shark records from the Sea of Marmara, and to update the species list with the addition of new data.

## MATERIAL AND METHODS

The area encompassed by the present research is a subunit of the Mediterranean Sea and known as the Sea of Marmara (Fig. 1). It is connected with the Mediterranean Sea via the Dardanelles and with the Black Sea

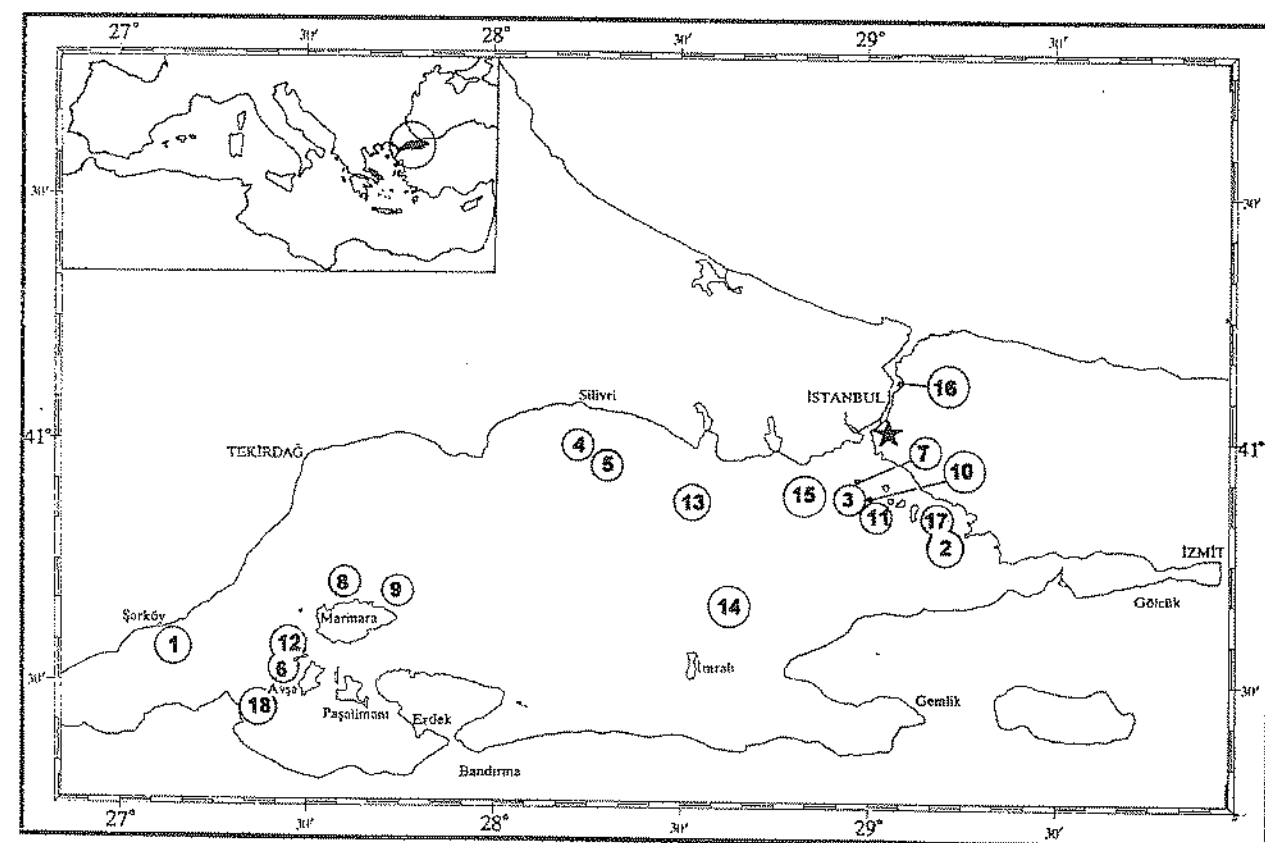

Fig. 1: Map of the study area; circled numbers indicate the sampling locations; ★ indicates the stranding site of *Carcharodon carcharias* in the Bosphorus Strait in February 1881.

Sl. 1: Zemljevid preučevanega območja; obkrožene številke označujejo posamezna vzorčišča; ★ ponazarja mesto v Bosporski ožini, kjer je februarja 1881 nasedel beli morski volk *Carcharodon carcharias*.

through the Bosphorus Strait. While Marmara's surface waters are affected by the Black Sea, its deeper layers remain under the influence of the Mediterranean (Kocataş *et al.*, 1993). According to Öztürk & Öztürk (1996), the Sea of Marmara is an ecological barrier, a transition zone or an acclimatisation area, influencing the dispersal of species between the Mediterranean and Black Seas.

An extensive field survey was carried out between 1991 and 1999 along the coast of Sea of Marmara (Fig. 1) to collect or examine sharks. Whenever possible, the author joined fishermen (mostly purse-seiners, gill-netters and bottom long-liners) to collect shark samples. Sharks delivered to the Istanbul Fish Market were also analysed for the purpose of this research. Furthermore, the available ichthyological literature on the Sea of Marmara was critically reviewed. The following data were recorded for each species: total length (TOT) in cm, sex of the animal, date and location of the capture. Total length of the specimens was measured with the caudal fin in the depressed position. Whenever possible, teeth and skin samples were also collected, now kept in the author's personal collection. Capture locations of the examined specimens, as well as those of recent records are shown in circled numbers in figure 1. Dashed lines in figure 1 indicate northern and southern borders of the bycatch area of *C. carcharias*, *L. nasus*, *A. vulpinus* and *P. glauca*, reported by Devedjian (1926), Ayaşlı (1937), Güney (1974), Üner (1984) and Akşiray (1987) from the Sea of Marmara.

For an easier understanding, status of occurrence of sharks recorded from the Sea of Marmara was classified under the following categories: (A) species examined in the present study; and (B) species cited by other researchers but not examined in the present study. Status of occurrence of each species is denoted in parentheses after its scientific name. The absence of a species in the recent catch records or in the recent general ichthyological lists, concerning exclusively the fish fauna of the Sea of Marmara, at least for the last 25 years, was used as the criteria for considering the species as "questionable".

Identification of the species follows Whitehead *et al.* (1984) and Compagno (1984a, b). Taxonomic nomenclature follows *European Register of Marine Species, Chondrichthyes brief checklist* (<http://erms.biol.soton.ac.uk/lists/>). All photographs (Fig 2-9) were taken by the author.

## RESULTS AND DISCUSSION

Field surveys and review of the available literature have revealed the presence, either confirmed or questionable, of 20 shark species, representing 11 families in the Sea of Marmara. Relevant details about these species are given below.

## Order Hexanchiformes

## Family Hexanchidae

1. *Hexanchus griseus* (Bonnaterre, 1788) (A)

Previous recordings: Ninni (1923, [Bilecenoğlu *et al.*, 2002]), Devedjian (1926, as *Notidanus griseus*), Üner (1984), Meriç (1995), Kabasakal (1998, 2002).

Material examined: 1 ♂ (TOT 250 cm) captured on February 20, 1997, off the coast of Şarköy (40°09'50" N, 27°18'40" E) at a depth of 50 m (Kabasakal, 1998) (Fig. 1, stat. 1); 1 ♀ (TOT 125 cm), captured in March 1997 off the coast of Şarköy (same location as the previous specimen, Fig. 1, st. 1); 2 ♀ (TOT 380 and 450 cm, respectively) captured off the coast of Tuzla, at a depth of 200 m (Fig. 1, st. 2), second specimen is shown in figure 2; 1 ♀ (TOT 420 cm) captured in December 1999 off the coast of Yassıada at a depth of 220 m (Fig. 1, st. 3).

According to Üner (1984), bluntnose sixgill shark is one of the common and largest sharks of the Sea of Marmara. Meriç (1995) recorded this species from the catches at depths between 120 to 350 m by gill-netting over the northern continental slope, describing it as a rare bycatch by demersal fishing gear.

## Order Lamniformes

## Family Lamnidae

2. *Carcharodon carcharias* (Linnaeus, 1758) (B)

Previous recordings: Devedjian (1926, as *Carcharodon Rondeletii*), Güney (1974), Üner (1984), Akşiray (1987), Fergusson (1996), Bilecenoğlu *et al.* (2002).

Devedjian (1926) reported on a great white shark (TOT 400 cm) captured in the Sea of Marmara, and added that its stomach content included a number of bonitos. According to Güney (1974) and Üner (1984), *C. carcharias* is present in the Sea of Marmara in all seasons and it approaches Marmaric entrance of the Bosphorus Strait especially in winter. One of the common points stated by these three authors was that the great white shark was usually a common bycatch by tuna handliners in the Sea of Marmara, and this one was captured incidentally as a result of chasing schools of tunas and bonitos. Üner (1984) also reported that most of the great white shark captures were made between December and late March, and that most of the individuals were captured around the Prince Islands (Fig. 1) and near the Bosphorus Strait. According to Akşiray (1987), *C. carcharias* inhabits the Sea of Marmara and rarely occurs near the Pontic entrance of the Bosphorus Strait. Fergusson (1996) reported the capture of three individuals of *C. carcharias* in the Sea of Marmara. These are: one stranded individual (TOT 391 cm) near Beyler-



beyi coast (Bosporus Strait) in February 1881 (★ in Fig. 1); 1 ♀ (TOT 470 cm, W 1500 kg), captured on November 17, 1881; and 1 ♀ (TOT 500+ cm, W 3750 kg), captured in February 1962. Fergusson (1996) stated that the weight of the last individual was no doubt an error. No contemporary record of *C. carcharias* is available, and no individual of this species was captured or even sighted during the field surveys. Although the presence of *C. carcharias* in the Sea of Marmara has been reported by Bilecenoğlu *et al.* (2002) in the *Checklist of the marine fishes of Turkey*, the information given herewith is probably based on previous recordings. Therefore, its current presence in Marmaric waters is "questionable" and requires confirmation.

### 3. *Lamna nasus* (Bonnaterre, 1788) (B)

Previous recordings: Ninni (1923, [Bilecenoğlu *et al.*, 2002]), Devedjian (1926, as *Lamna cornubica*), Güney (1974), Üner (1984), Akşiray (1987), Bauchot (1987), Mater & Meriç (1996), Bilecenoğlu *et al.* (2002), Kabasakal (2002).

Although no capture information on *L. nasus* individuals is available, porbeagle is, according to Devedjian (1926), Güney (1974), Üner (1984) and Akşiray (1987), yet another common lamnoid shark of the Sea of Marmara, with most of its captures made around the Prince Islands and near the Marmaric entrance to the Bosporus Strait (Fig. 1). Güney (1974) and Üner (1984) also reported that, as for *C. carcharias*, bycatches of *L. nasus* by tuna fishing gear occurred mostly in the winter, as a result of chasing schools of tunas and bonitos. The

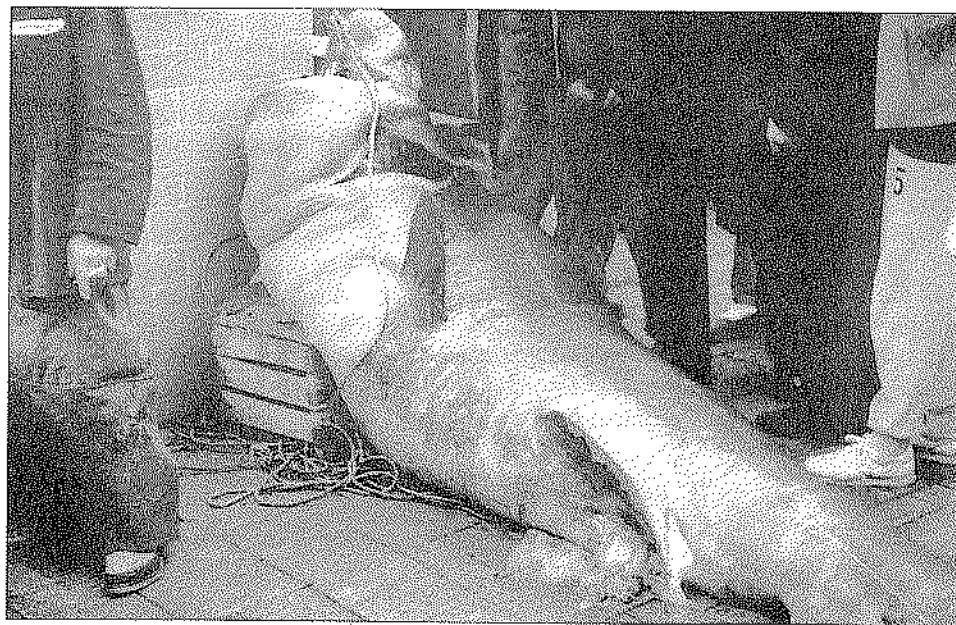

Fig. 2: *Hexanchus griseus* (Bonnaterre, 1788) (♀, TOT 450 cm) displayed at a fish market in Istanbul.  
Sl. 2: *Hexanchus griseus* (Bonnaterre, 1788) (♀, TOT 450 cm), postavljen na ogled na istanbulski ribji tržnici.

recording of *L. nasus* by Kabasakal (2002) from the Sea of Marmara is based on previous recordings of this species by other researchers. Although the presence of *L. nasus* in the Sea of Marmara has been reported by Bilecenoğlu *et al.* (2002), the information given herewith is probably based on previous recordings. No individual of this species was captured or even sighted during the field surveys. Therefore, its current presence in Marmaric waters is "questionable" and requires confirmation.

Family Alopiidae

### 4. *Alopias vulpinus* (Bonnaterre, 1788) (A)

Previous recordings: Ninni (1923, [Bilecenoğlu *et al.*, 2002]), Devedjian (1926, as *Alopias vulpes*), Erazi (1942, as *Alopias vulpes*), Üner (1984), Kocataş *et al.* (1993), Kabasakal (2002).

Material examined: 1 ♂ (TOT 190 cm) captured on April 12, 1997, off the coast of Silivri (Fig. 1, st. 4).

Devedjian (1926) reported on some enormous *A. vulpinus* individuals ending at the Istanbul Fish Market, without giving information on their size or biology. Its presence in the Sea of Marmara was possibly the result of chasing the pelagic fish schools. As *A. vulpinus* is a highly migratory shark (Compagno, 1984a), it is necessary to investigate its movements in detail to figure out whether its presence in the Sea of Marmara is regular or just incidental. Despite this uncertainty, *A. vulpinus* is the only confirmed pelagic shark species recorded in Marmaric waters during the present research.

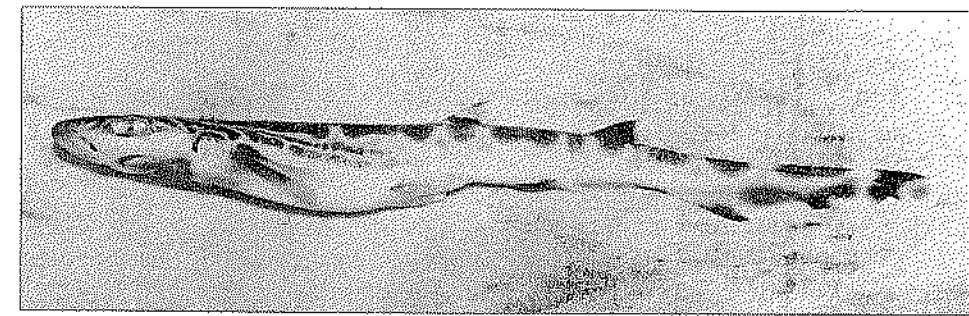

Fig. 3/Sl. 3: *Galeus melastomus* Rafinesque, 1810 (♂, TOT 22 cm).

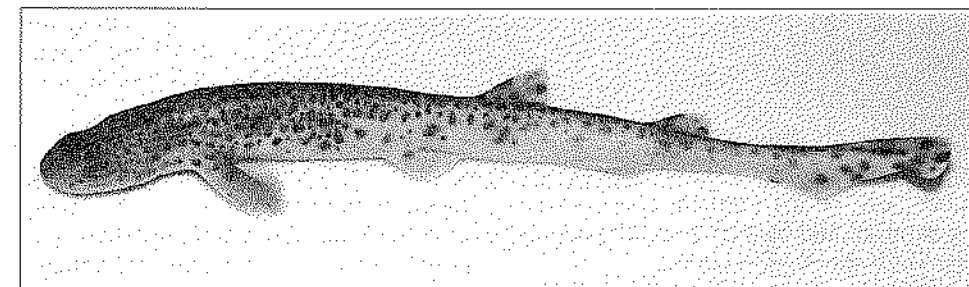

Fig. 4/Sl. 4: *Scyliorhinus canicula* (Linnaeus, 1758) (♂, TOT 20.5 cm).

## Order Carcharhiniformes

Family Scyliorhinidae

### 5. *Galeus melastomus* Rafinesque, 1810 (A)

Previous recordings: Akşiray (1987), Bauchot (1987), Kocataş *et al.* (1993), Meriç (1995), Mater & Meriç (1996), Uysal *et al.* (1996), Kabasakal (2002).

Material examined: 2 ♂ (TOT 22 and 30 cm, respectively; first specimen shown in Fig. 3), captured on October 20, 1996, off the coast of Silivri (40°57'00" N, 28°16'15" E) (Fig. 1, st. 5) at a depth of 350 m.

Meriç (1995) reported a bycatch of *G. melastomus* in bottom set gill-nets over the northern continental slope between depths of 120 to 350 m. According to Uysal *et al.* (1996), *G. melastomus* is a rare shark in the Sea of Marmara, captured at depths greater than 200 m.

### 6. *Scyliorhinus canicula* (Linnaeus, 1758) (A)

Previous recordings: Devedjian (1926, as *Scyllium canicula*), Ayaşlı (1937), Erazi (1942, as *Scyllium canicula*), Akşiray (1987), Bauchot (1987), Kocataş *et al.* (1993), Meriç (1995), Mater & Meriç (1996), Okuş *et al.* (1996), Kabasakal (2002).

Material examined: 2 ♂ (TOT 20.5 and 40.7 cm, respectively); first specimen shown in Fig. 4) and 12 ♀ (TOT 20 to 38 cm) captured in June 1991 off the western coast of Ekinlik Island at a depth of 47 m (Fig. 1, st. 6); 6 ♂ (TOT 20 to 36 cm) and 2 ♀ (TOT 30 and 30.2

cm, respectively) captured in October 1994 off the northern coast of Yassiada at depth of 87 m (Fig. 1, st. 7). Many egg capsules, attached to the gorgonians and black corals, were observed at Ekinlik station (Fig. 1, st. 6).

Smallspotted catshark is the most common scyliorhinid species in the Sea of Marmara and most of its bycatches were made in the south-western part of this sea (Okuş *et al.*, 1996). It has also been caught in bottom set gill-nets over the northern continental slope, although in insignificant numbers (Meriç, 1995).

### 7. *Scyliorhinus stellaris* (Linnaeus, 1758) (A)

Previous recordings: Ninni (1923, [Bilecenoğlu *et al.*, 2002]), Akşiray (1987), Bauchot (1987), Kocataş *et al.* (1993), Mater & Meriç (1996), Kabasakal (2002).

Material examined: 1 ♀ (TOT 83 cm, Fig. 5) captured in March 1997 off the southern coast of Ekinlik Island at a depth of 47 m (Fig. 1, st. 6); one egg capsule was observed in each uteri; jaws preserved.

*S. stellaris* is a rare scyliorhinid shark in the Sea of Marmara and its records are generally confined to the south-western part of this sea.

Family Triakidae

### 8. *Galeorhinus galeus* (Linnaeus, 1758) (B)

Previous recordings: Ninni (1923, [Bilecenoğlu *et al.*, 2002]), Devedjian (1926, as *Galeus canis*).



Although the presence of *G. galeus* in the Sea of Marmara has been reported by Bilecenoğlu *et al.* (2002), the information given herewith is probably based on previous recordings. In his monumental work, Akşiray (1987) placed *G. galeus* and other triakids in Carcharhinidae, but while reporting on the presence of tope shark in Turkish seas, the author gave no specific information whether it was still present in the Sea of Marmara. Furthermore, no contemporary records of *G. galeus* from this sea are available. No individual of this species was captured or even sighted during the field surveys. Therefore, the current presence of *G. galeus* in Marmaric waters seems "questionable" and requires confirmation.

#### 9. *Mustelus asterias* Cloquet, 1821 (A)

Previous recordings: Meriç (1995), Mater & Meriç (1996), Kabasakal (2002).

Material examined: 1 ♀ (TOT 125 cm; Fig. 6) captured in November 1997 off the northern coast of Marmara Island at a depth of 100 m (Fig. 1, st. 8); embryos carrying yolk sacs were observed in uteri.

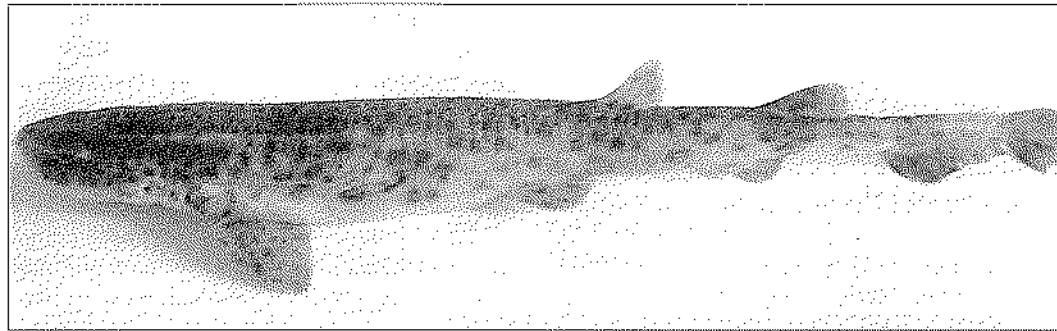

Fig. 5/Sl. 5: *Scylliorhinus stellaris* (Linnaeus, 1758) (♀, TOT 83 cm).

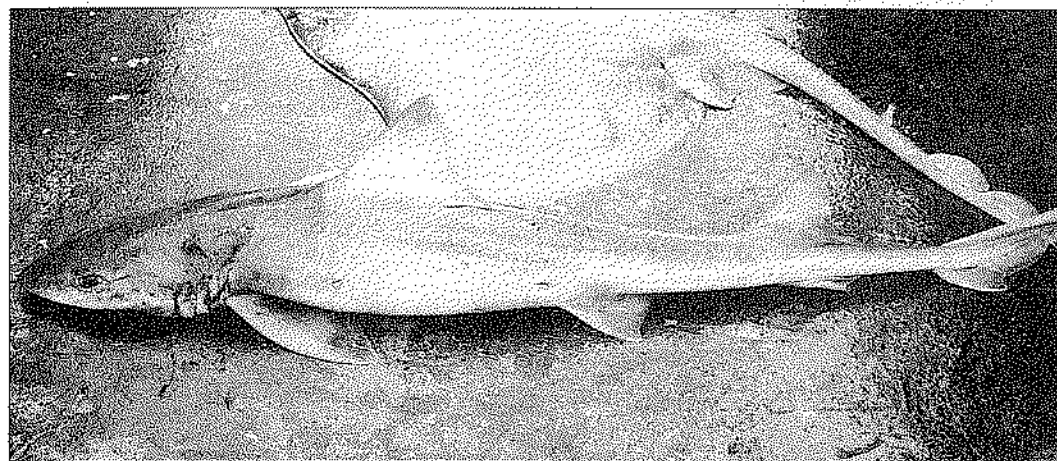

Fig. 6/Sl. 6: *Mustelus asterias* Cloquet, 1821 (♀, TOT 125 cm).

Meriç (1995) reported *M. asterias* from slope waters of the northern Marmara. Compared with the following congeneric species, it is quite rare in the Sea of Marmara.

#### 10. *Mustelus mustelus* (Linnaeus, 1758) (A)

Previous recordings: Devedjian (1926, as *Mustelus vulgaris*), Erazi (1942, as *Mustelus vulgaris*), Kocataş *et al.* (1993), Meriç (1995), Mater & Meriç (1996), Okuş *et al.* (1996), Kabasakal (2002).

Material examined: 1 ♀ (TOT 120 cm) captured in the winter of 1995 off the northern coast of Marmara Island at a depth of 90 m (Fig. 1, st. 9), jaws of this specimen preserved; 1 ♀ (TOT 36 cm) captured in June 1999 off the northern coast of Yassıada at a depth of 80 m (Fig. 1, st. 10); unhealed umbilical scar observed on this specimen.

Meriç (1995) reported on *M. mustelus* from slope waters of the northern Marmara. According to Okuş *et al.* (1996), distribution of this shark is prevalent in the south-western part of the Sea of Marmara.

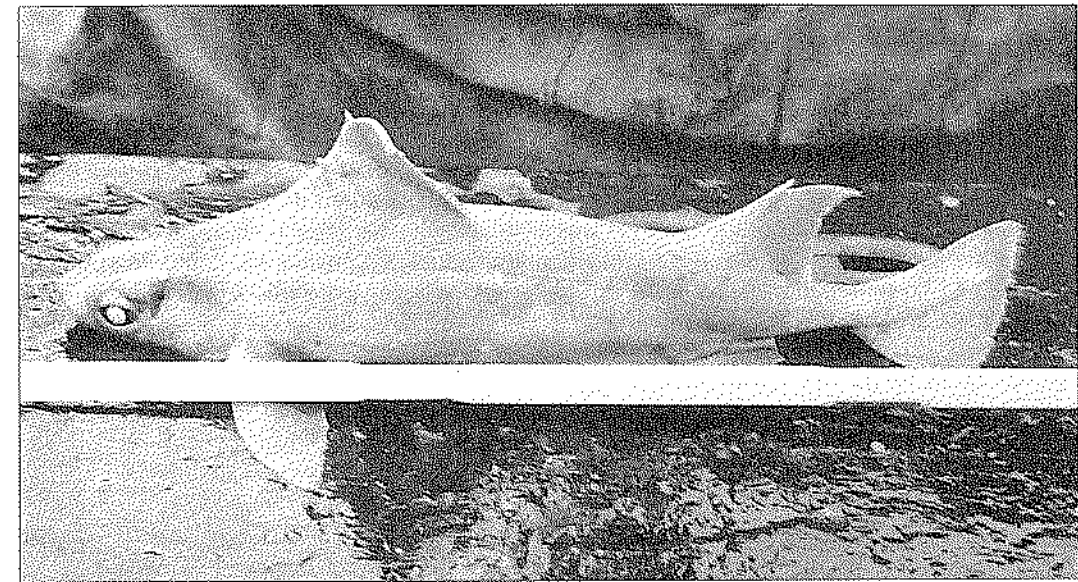

Fig. 7/Sl. 7: *Oxynotus centrina* (Linnaeus, 1758) (♀, TOT 40 cm).

#### Family Carcharhinidae

#### 11. *Prionace glauca* (Linnaeus, 1758) (B)

Previous recordings: Ninni (1923, [Bilecenoğlu *et al.*, 2002]), Devedjian (1926, as *Carcharias glaucus*), Ayaşlı (1937, as *Carcharias glaucus*), Güney (1974), Üner (1984), Bilecenoğlu *et al.* (2002).

Record of an enormous blue shark (TOT 800 cm) delivered to the Istanbul Fish Market (Ayaşlı, 1937). The author stated that the stomach content of this individual included remains of tuna fish and dolphin. However, regarding the maximum confirmed size (383 cm) of the blue shark and the unconfirmed reports on larger 480 to 650 cm long individuals (Compagno, 1984b), the size of this individual reported by Ayaşlı (1937) seems "unreasonable". Furthermore, we could hypothesize that by considering the size (TOT 800 cm) and stomach contents (tuna fish and dolphin), *Prionace glauca* reported by Ayaşlı (1937) was actually a *Carcharodon carcharias*. No photographs or parts of this individual have been preserved. Güney (1974) and Üner (1984) reported that, as far as lamnoid sharks are concerned, bycatches of *P. glauca* in tuna fishing gear mostly occurred around the Prince Islands and near the Marmaric entrance to the Bosphorus Strait. No individual of *P. glauca* was captured or even sighted during the field surveys, and no contemporary record of this shark from this sea is available. Although the presence of *P. glauca* in the Sea of Marmara has been reported by Bilecenoğlu *et al.* (2002), the information given herewith is probably based on previous recordings. Its current presence in the Sea of Marmara seems "questionable" and requires confirmation.

#### Order Squaliformes

#### Family Dalatiidae

#### 12. *Oxynotus centrina* (Linnaeus, 1758) (A)

Previous recordings: Erazi (1942, as *Squalus centrina*), Mater & Meriç (1996), Kabasakal (2002).

Material examined: 1 ♀ (TOT 40 cm, Fig. 7) captured in November 1994 off the northern coast of Yassıada at a depth of 90 m (Fig. 1, st. 11); 2 ♂ (TOT 35 to 41 cm, respectively) captured in February 1996 off the western coast of Ekinlik Island at a depth of 60 m (Fig. 1, st. 12).

*O. centrina* is a rare bycatch by bottom set gill-nets and long-lines in the Sea of Marmara.

#### 13. *Dalatias licha* (Bonnaterre, 1788) (B)

Previous recordings: Meriç (1995), Kabasakal (2002). Meriç (1995) reported on a single male (TOT 34.5 cm) captured on July 5, 1991, off the coast of Büyükçekmece (Fig. 1, st. 13) at a depth of 270 m. No *D. licha* individual was captured during the field surveys. It is very rare in the Sea of Marmara, and no information is available on its distribution in the Sea of Marmara.

#### Family Centrophoridae

#### 14. *Centrophorus granulosus* (Bloch & Schneider, 1801) (B)

Previous recordings: Benli *et al.* (1993), Meriç (1995), Mater & Meriç (1996), Kabasakal (2002).



*C. granulatus* has been recorded for the first time in the Sea of Marmara by Benli *et al.* (1993); the record is based on 5 specimens captured in the autumn of 1992 at a depth of 400 m (40°36'05" N, 28°36'03" E) (Fig. 1, st. 14). Meriç (1995) reported that gulper sharks were rarely captured by bottom set gill-nets between depths of 120 to 350 m over the northern continental slope of the Sea of Marmara. No individual of *C. granulatus* was captured during the field surveys. It is very rare in the Sea of Marmara, and no information is available on its distribution in the Sea of Marmara.

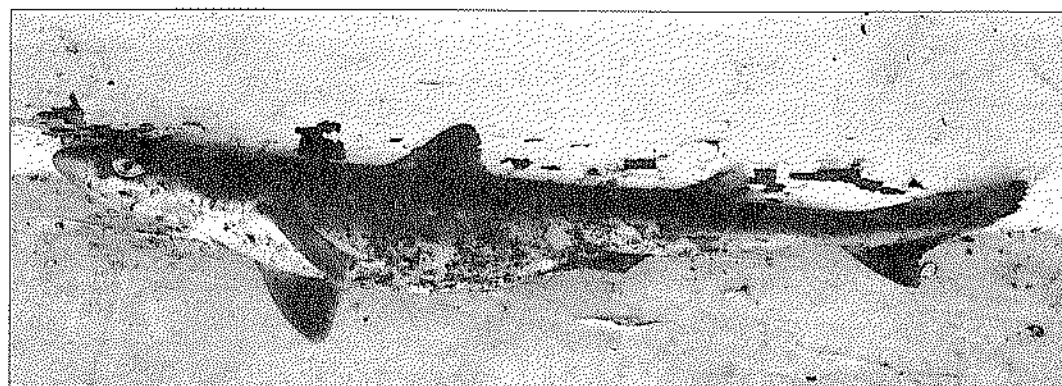

Fig. 8/Sl. 8: *Squalus acanthias* Linnaeus, 1758 (♂, TOT 45 cm).

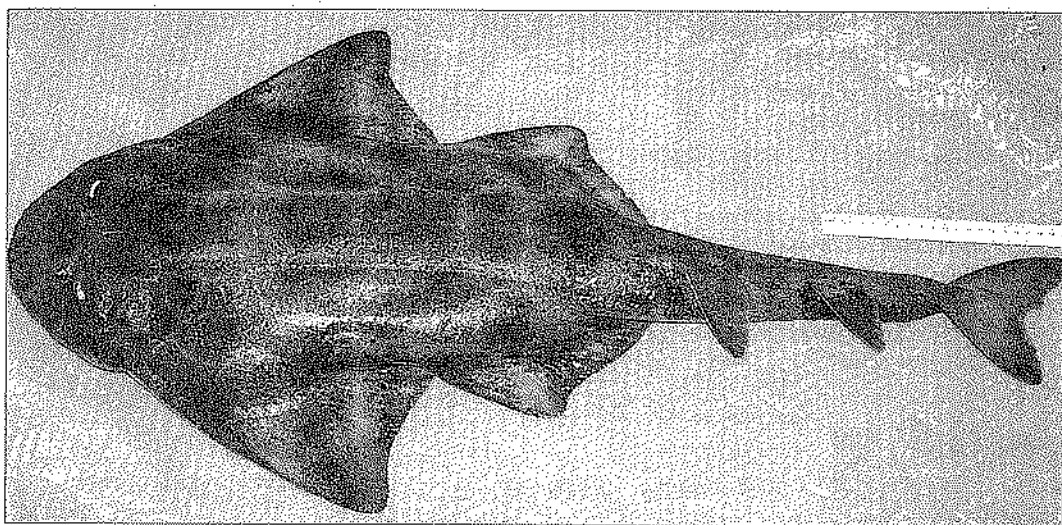

Fig. 9/Sl. 9: *Squatina squatina* (Linnaeus, 1758) (♀, TOT 87 cm).

#### Family Squalidae

##### 16. *Squalus acanthias* Linnaeus, 1758 (A)

Previous recordings: Ninni (1923, [Bilecenoğlu *et al.*, 2002]), Devedjian (1926, as *Acanthias vulgaris*), Erazi (1942), Bauchot (1987), Meriç (1995), Mater & Meriç (1996), Kabasakal (2002).

##### 15. *Centrophorus uyato* (Rafinesque, 1810) (B)

Previous recordings: Meriç (1995), Kabasakal (2002). Meriç (1995) reported on a female (TOT 44.2 cm) captured on May 19, 1989, off the coast of Yeşilköy (Fig. 1, st. 15) at a depth of 150 m and on a male (TOT 45.3 cm) captured on August 11, 1991, off the coast of Büyükçekmece (Fig. 1, st. 13) at a depth of 270 m. No individual of *C. uyato* was captured during the field surveys. It is very rare in the Sea of Marmara, and no information is available on its Marmaric distribution.

Material examined: 1 ♂ (TOT 45 cm) captured in September 1994 in the Bay of Beykoz at a depth of 50 m (Fig. 1, st. 16), specimen shown in Fig. 8; 1 ♀ (TOT 105 cm) captured in October 1995 off the eastern coast of Büyükkada at a depth of 65 m (Fig. 1, st. 17); 1 ♂ (TOT 85 cm) captured in June 1999 off the northern coast of Yassiada at a depth of 80 m (Fig. 1, st. 10).

Spiny dogfish is one of the well-known sharks of the

Sea of Marmara and a common bycatch by bottom set gill-nets and long-lines. In terms of sea fishery in the Sea of Marmara, Kocataş *et al.* (1993) considered this species a commercially important demersal fish. Meriç (1995) reported it as common over the northern continental slope.

##### 17. *Squalus blainvillei* (Risso, 1826) (A)

Previous recordings: Devedjian (1926, as *Acanthias blainvillii*), Erazi (1942), Bauchot (1987), Kocataş *et al.* (1993), Meriç (1995), Mater & Meriç (1996), Okuş *et al.* (1996), Kabasakal (2002).

Material examined: 2 ♀ (TOT 65 and 73 cm, respectively) captured in June 1999 off the northern coast of Yassiada at a depth of 80 m (Fig. 1, st. 10).

Meriç (1995) reported *S. blainvillei* from slope waters of the northern Marmara. (2002), According to Okuş *et al.* (1996), it is distributed mostly in the south-western part of this sea. In comparison with the preceding congeneric species, Kocataş *et al.* (2002) consider it an economically important species, but its occurrence in Marmaric waters is quite rare.

#### Family Echinorhinidae

##### 18. *Echinorhinus brucus* (Bonnaterre, 1788) (B)

Previous recordings: Ninni (1923, [Bilecenoğlu *et al.*, 2002]), Devedjian (1926, as *Echinorhinus spinosus*).

According to Devedjian (1926), *E. brucus* is a common shark in Marmaric waters. Although the bramble shark's presence in the Sea of Marmara has been reported by Bilecenoğlu *et al.* (2002), the information given herewith is probably based on previous recordings. Although Akşiray (1987) claims that *E. brucus* is present in Turkish seas, the author has not given any specific information whether it is still present in the Sea of Marmara. Furthermore, no contemporary recording indicating the bramble shark's presence in this sea is available, and neither was any individual of this species captured or even sighted during the field surveys. Therefore, the current presence of *E. brucus* in the Sea of Marmara seems "questionable" and requires confirmation.

#### Order Squatiniformes

#### Family Squatinidae

##### 19. *Squatina oculata* Bonaparte, 1840 (B)

Previous recordings: Slastenenko (1955-1956, [Bilecenoğlu *et al.*, 2002]), Meriç (1994, [cited in Bilecenoğlu *et al.*, 2002]).

While no *S. oculata* individual was captured or

sighted during the field surveys, its presence in the Sea of Marmara is based on a recent report by Meriç (1994). No current information, however, is available on its distribution in the Sea of Marmara.

##### 20. *Squatina squatina* (Linnaeus, 1758) (A)

Previous recordings: Ninni (1923, [Bilecenoğlu *et al.*, 2002]), Devedjian (1926, as *Rhina squatina*), Erazi (1942), Roux (1984), Kocataş *et al.* (1993), Mater & Meriç (1996), Kabasakal (2002).

Material examined: 1 ♀ (TOT 87 cm; Fig. 9) captured in November 1995 off the coast of Karabiga at a depth of 50 m (Fig. 1, st. 18).

It is a quite common and economically important demersal shark in the Sea of Marmara.

#### CONCLUSIONS

Twenty species of sharks, with either confirmed or questionable presence in the Sea of Marmara, comprise nearly 8% of the total ichthyofauna (a total of 249 species, reported by Bilecenoğlu *et al.*, 2002) of Marmaric waters. Regarding their species numbers, squaliform and carcharhiniform sharks, each represented by 7 species, dominated the shark species composition in Marmaric waters.

In the Sea of Marmara, the continental shelf on the southern side is wide and extends nearly to the centre of the sea, while on the northern side the shelf is narrow, with the slope's depth exceeding 1000 m (1335 m at its deepest point) with a steep inclination (Kocataş *et al.*, 1993). The topographic structure of the Sea of Marmara has no doubt influenced the distribution of demersal sharks in this sea. With the exception of *E. brucus*, a species not recorded in this research, the remaining squaliform sharks, scyliorhinid *G. melastomus*, and the adult individuals of *H. griseus*, have been mostly captured over the deeper parts of the shelf and upper slope on the northern side. Squaliform sharks, recorded in this research, mostly prefer to live over the continental shelf and the upper slope. Maximum range of the depth distribution of *C. granulatus*, *C. uyato* and *D. licha* exceeds 1000 m (Compagno, 1984a). Furthermore, it is known that, while *H. griseus* lives at depths from the surface down to 1800 m, adults prefer waters deeper than 100 m (Compagno, 1984a), and *G. melastomus* lives at depths between 55 and 1000 m, with preference to deeper parts of the shelf and the upper slope (Compagno, 1984b). Regarding depth distribution of the above mentioned species, the northern slope of the Sea of Marmara thus offers a suitable habitat for them. On the other hand, triakids, *M. asterias* and *M. mustelus*, and scyliorhinids, *S. canicula* and *S. stellaris*, as well as the young individuals of *H. griseus* and *S. squatina* have been mostly captured in the southern part of Marmara.



Although maximum range of depth distribution of *S. canicula* and *M. mustelus* can exceed 200 m, both scyliorhinids and triakids as well as squatinids prefer moderate depths over the continental slope (Compagno, 1984a,b). Moreover, young individuals of *H. griseus* mostly occur in shallow waters (Compagno, 1984a). Therefore, the extended continental shelf on the southern part offers a suitable habitat for the mentioned species. Okuş *et al.* (1996) also reported that the distribution of scyliorhinids and triakids prevailed along the southern coast of the Sea of Marmara.

One of the special characteristics of the southern Marmara is the presence of areas occupied by rich growth of gorgonians and black corals (Öztürk & Bourguet, 1990). These sedentary organisms offer suitable spawning grounds for oviparous sharks, such as scyliorhinids. Many egg cases attached to gorgonians or black corals, as well as juveniles of *S. canicula*, and a gravid female of *S. stellaris*, were observed in the southern Marmara, mostly along the coasts of the southern Marmara islands (Fig. 1) during the field surveys, and these findings indicate a nursery ground of scyliorhinid sharks in the southern part of this sea. This area may also be a nursery ground for *H. griseus* and *M. asterias*, as some young sixgill sharks and a gravid female of *M. asterias* were also captured here. The capture of a newborn individual of *M. mustelus*, bearing an unhealed umbilical scar, off the northern coast of Yassiada (Fig. 1, st. 10) indicate the presence of another nursery ground for the triakids in the northern Marmara. The current fisheries act prohibits any fishery action for the black corals, which is no doubt a beneficial limitation regarding the conservation of shark nurseries in the Sea of Marmara. However, extensive investigations are needed for the exact mapping of shark nurseries in this sea.

The actual status of pelagic sharks in the Sea of Marmara has always been a point of discussion. Although some previous records of pelagic sharks are at

hand, their contemporary records from Marmaric waters are scarce. *A. vulpinus* is the only pelagic species recorded during the present research. According to the available data, bycatch of pelagic sharks in the Sea of Marmara has been paralleled with tuna fishery in the past. However, due to the drastic decline in the bluefin tuna populations and other pelagic bony fishes, the fishery of this commercially important species in Marmaric waters has almost ended since the 1980's (Karakulak & Oray, 1994), and the latest records of pelagic shark captures from Marmara correspond with these years (Üner, 1984). This drastic decline in pelagic teleosts has certainly resulted in the loss of important food source of these apex predators in Marmaric waters, the same as the end of the mentioned tuna fishery resulted in the loss of bycatch possibility as far as pelagic sharks are concerned. The capture of a young *A. vulpinus* individual on April 12, 1997, off the coast of Silivri (Fig. 1, st. 4) is probably the only confirmed pelagic shark record from the Sea of Marmara in the last 20 years.

Consequently, among the 20 shark species recorded in the Sea of Marmara, the current presence of 5 species, *i.e.* *C. carcharias*, *L. nasus*, *G. galeus*, *P. glauca* and *E. brucus*, is questionable, and for the time being it is not possible to say whether their Mediterranean distribution still extends to Marmaric waters. Although the occurrence of *O. centrina*, *D. licha*, *C. granulosus*, *C. uyato* and *S. oculata* was not considered questionable in the present study, they should be considered rare sharks, since each of the species has been recorded either by the author of this contribution or by other researchers only once or twice in the Sea of Marmara during the last decade.

#### ACKNOWLEDGEMENTS

The author wishes to thank all the fishermen for their help during the carried out field surveys.

## STAREJŠI IN NOVEJŠI PODATKI O POJAVLJANJU MORSKIH PSO V MARMARSKEM MORJU, TURČIJA

Hakan KABASAKAL

Ichthyological Research Society, Atatürk Mahallesi, Menteşoğlu Caddesi, İdil apt., No 30, D 4, TR-34764 Ümraniye, Istanbul  
E-mail: hakankabasakal@hotmail.com

#### POVZETEK

Dvajset vrst morskih psov, katerih pojavljanje v Marmarskem morju je bodisi potrjeno bodisi vprašljivo, obsega skoraj 8% celotne marmarske ihtiofavne. Kar zadeva število vrst teh psov, so v teh vodah prevladovali trneži in vrste iz družine Carcharhinidae, oboji s po 7 vrstami. Trneži, morska mačka *Galeus melastomus* in odrasli osebkki šesteroškrgarja *Hexanchus griseus* so bili večinoma ujeti nad globljimi deli morske police in gornjim pobočjem na severni strani Marmarskega morja, pegasti morski pes *Mustelus asterias*, navadni morski pes *M. mustelus*, morski mački *Scyliorhinus canicula* in *S. stellaris* kot tudi mladiči šesteroškrgarja *H. griseus* in navadni sklat *Squatina squatina* pa večinoma v južnem delu Marmarskega morja. Morska lisica *Alopias vulpinus* je edina pelagična vrsta, ki je bila zabeležena med pričujočimi raziskavami. Trenutno pojavljanje 5 vrst, *Carcharodon carcharias*, *Lamna nasus*, *Galeorhinus galeus*, *Prionace glauca* in *Echinorhinus brucus*, je vprašljivo, tako da trenutno ne vemo, ali se njihova razširjenost v Sredozemskem morju nadaljuje tudi v marmarskih vodah. Južni del Marmarskega morja se zdi ustrezno razmnoževalno okolje, predvsem za *Scyliorhinidae* in *Triakidae*.

**Ključne besede:** morski psi, razširjenost, naključno ujetje, razmnoževalno okolje, Marmarsko morje

#### REFERENCES

- Aksıray, F. (1987): Türkiye Deniz Balıkları ve Tayin Anahtarı. 2<sup>nd</sup> Edition. Publications of Istanbul University, no. 3490, Istanbul, 811 pp.
- Ayaşlı, S. (1937): Boğaziçi Balıkları. Cumhuriyet Matbaası, İstanbul, 72 pp.
- Bauchot, M. -L. (1987): Requins. In: Fischer, W., M. Schneider & M.-L. Bauchot (eds.): Fiches FAO d'identification des espèces pour les besoins de la pêche. (Révision 1). Méditerranée et mer Noire. Zone de pêche 37. Vol. II. Vertebres. FAO, Roma, p. 767-843.
- Benli, H. A., B. Cihangir & K.C. Bizsel (1993): A new record for the Sea of Marmara; (Family: Squalidae) *Centrophorus granulosus* (BLOCH & SCHNEIDER, 1801). Tr. J. Zool., 17(2), 133-135.
- Bilecenoglu, M., E. Taskavak, S. Mater & M. Kaya (2002): Checklist of the marine fishes of Turkey. Zootaxa 113. Magnolia Press, Auckland, 194 pp.
- Compagno, L. J. V. (1984a): FAO species catalogue. Vol. 4. Sharks of the world. An annotated and illustrated catalogue of shark species known to date. Part 1. Hexanchiformes to Lamniformes. FAO Fish. Synop., 125(4), 1-249.
- Compagno, L. J. V. (1984b): FAO species catalogue. Vol. 4. Sharks of the world. An annotated and illustrated catalogue of shark species known to date. Part 2. Carcharhiniformes. FAO Fish. Synop., 125(4), 251-655.
- Devedjian, K. (1926): Pêche en Pêcheries en Turquie. Imprimerie de l'Administration de la Dette Publique Ottomane, Istanbul, 480 pp.
- Erazi, R. A. R. (1942): Marine fishes found in the Sea of Marmara and in the Bosphorus. Revue de la Faculté des Sciences de l'Université d'Istanbul, B, 7(1/2), 103-115.
- Fergusson, I. K. (1996): Distribution and autecology of the white shark in the eastern North Atlantic Ocean and the Mediterranean Sea. In: Klimley, A. P. & D. G. Ainley (eds.): Great white sharks: The biology of *Carcharodon carcharias*. San Diego, Academic Press, p. 321-345.
- Güney, K. (1974): Balıklarımız. Redhouse Yayınevi, İstanbul, 46 pp.
- Kabasakal, H. (1998): The first record of the bluntnose six-gill shark [*Hexanchus griseus* (BONNATERRE, 1788)] in the Sea of Marmara. Acta Adriat., 39(1), 67-70.
- Kabasakal, H. (2002): Elasmobranch species of the seas of Turkey. Annales Ser. hist. nat., 12(1), 15-22.
- Karakulak, F. S. & I. K. Oray (1994): The length-weight relationship of the bluefin tunas (*Thunnus thynnus* L., 1758) caught in Turkish waters. Istanbul University, Journal of Aquatic Products, 8(1-2), 159-171.
- Kocataş, A., T. Koray, M. Kaya & Ö. F. Kara (1993): Review of the fishery resources and their environment in the Sea of Marmara. Studies and Reviews, General Fisheries Council for the Mediterranean, 64, Fisheries and Environmental Studies in the Black Sea. FAO, Roma, p. 87-143.



**Mater, S. & N. Meriç (1996):** Deniz Balıkları. In: Kence, A. & C. C. Bilgin (eds.): Türkiye Omurgalıları Tür Listesi, TÜBİTAK, Ankara, 183 pp.

**Meriç, N. (1994):** Some uncommon fishes from the Turkish seas. XII. Ulusal Biyoloji Kongresi, Edirne, p. 295-299.

**Meriç, N. (1995):** A study on existence of some fishes on the continental slope of the Sea of Marmara. Tr. J. Zool., 19(2), 191-198.

**Ninni, E. (1923):** Primo contributo allo studio dei pesci e della pesca nelle acque dell'impero Ottomano. Missione Italiana per l'esplorazione dei Mari di Levante, Venezia, 187 pp.

**Okuş, E., A. Uysal & A. Yüksek (1996):** Marmara Denizinde köpekbalığı dağılımı. XIII. Ulusal Biyoloji Kongresi, September 17-20, 1996. Book of Abstracts, University of Istanbul, Faculty of Sciences, Istanbul, p. 31.

**Öztürk, B. & J. P. Bourguet (1990):** Données préliminaires sur le corail noir, *Gerardia savaglia* (BERTOLINI, 1819) de la Mer de Marmara. Istanbul University, Journal of Aquatic Products, 4(2), 45-48.

**Öztürk, B. & A. A. Öztürk (1996):** On the biology of the Turkish straits system. Bull. Inst. Oceanogr. Monaco, No. spécial 17, 205-221.

**Roux, C. (1984):** Squatinidae. In: Whitehead, P. J. P., M.-L. Bauchot, J.-C. Hureau, J. Nielsen & E. Tortonese (eds.): Fishes of the North-eastern Atlantic and the Mediterranean. Vol. I, UNESCO, Paris, p. 148-150.

**Slastenenko, E. (1955-56):** The fishes of the Black Sea basin. Et ve Balık Kurumu Umum Müd. Yayınları, Istanbul, 711 pp.

**Uysal, A., A. Yüksek & E. Okuş (1996):** Marmara Denizinde ender rastlanan üç elasmobranchii türü ve dağılımları (*Raja naevus* MULLER & HENLE, 1842; *Raja oxyrinchus* LINNAEUS, 1758; *Galeus melastomus* RAFINESQUE, 1809). XIII. Ulusal Biyoloji Kongresi, September 17-20, 1996. Book of Abstracts, University of Istanbul, Faculty of Sciences, Istanbul, p. 28.

**Üner, S. (1984):** Balık avcılığı ve yemekleri. Say Yayıncılık, Istanbul, 143 pp.

**Whitehead, P. J. P., M.-L. Bauchot, J.-C. Hureau, J. Nielsen & E. Tortonese (eds.) (1984):** Fishes of the North-eastern Atlantic and the Mediterranean. Vol. I. UNESCO, Paris, 510 pp.

original scientific article  
received: 2003-01-05

UDK 597.3(262-13)

## RECORDS OF BASKING SHARKS, *CETORHINUS MAXIMUS* (GUNNERUS, 1765) (CHONDRICHTHYES: CETORHINIDAE) OFF THE MAGHREBIN SHORE (SOUTHERN MEDITERRANEAN): A SURVEY

Christian CAPAPÉ

Laboratoire d'Ichtyologie, Université Montpellier II, Sciences et Techniques du Languedoc, F-34 095 Montpellier cedex 05

E-mail: capape@univ-montp2.fr

Farid HEMIDA & Jalil BENSACI

Laboratoire Halieutique, Institut des Sciences de la Nature, Université des Sciences et Techniques Houari Boumediene, 16111 Bab Ezzouar, Alger, B. P. 32, El Alia, Algérie

Béchir SAÏDI & Mohamed Nejmeddine BRADAI

Institut National des Sciences et Technologies de la Mer, Centre de Sfax, 3018 Sfax, B. P. 1035, Tunisie

### ABSTRACT

In the present paper, the authors list a number of records on historical and recent captures of *Cetorhinus maximus* off the Maghrebine shore (Algerian and Tunisian coasts) and compare them with similar data concerning other Mediterranean areas. They discuss and comment on the occurrence of the basking shark population in the Mediterranean Sea.

**Key words:** Chondrichthyes, Cetorhinidae, *Cetorhinus maximus*, Maghrebine shore, Algeria, Tunisia, Mediterranean Sea

## SEGNALAZIONI DI SQUALO ELEFANTE, *CETORHINUS MAXIMUS* (GUNNERUS, 1765) (CHONDRICHTHYES: CETORHINIDAE) DI FRONTE ALLA COSTA MAGREBINA (MEDITERRANEO MERIDIONALE): INDAGINE

### SINTESI

Nell'articolo gli autori espongono minuziosamente dati storici e recenti di catture di *Cetorhinus maximus* di fronte alla costa magrebina (algerina e tunisina), e li confrontano con dati simili provenienti da altre aree del Mediterraneo. Gli autori inoltre discutono e commentano la presenza della popolazione di squalo elefante nel mar Mediterraneo.

**Parole chiave:** Chondrichthyes, Cetorhinidae, *Cetorhinus maximus*, costa magrebina, Algeria, Tunisia, mare Mediterraneo



## INTRODUCTION

Out of the fourteen large migratory sharks reported off the Maghreb shore (Quignard & Capapé, 1971, 1972; Capapé, 1987, 1989; Hemida, 1998; Bradai, 2000; Hemida & Labidi, 2001; Hemida & Capapé, 2002, 2003; Hemida et al., 2002a, b), only three species, the sandbar shark, *Carcharhinus plumbeus*, the spinner shark, *C. brevipinna*, and the blue shark, *Prionace glauca*, reproduce and develop in the area (Capapé, 1984, 1989; Hemida & Capapé, 2003). The other migratory sharks are occasionally captured in the area. In the last ten years, records of basking sharks from the waters off the Maghreb shore have been more frequent (Bradai, 2000) than those reported earlier on by other authors (Dieuzeide et al., 1953; Quignard & Capapé, 1971; Capapé, 1975; Capapé et al., 1975). In this paper, the authors present historical and recent records of *C. maximus* off the Maghreb shore and compare its occurrence with those in other Mediterranean areas, such as the Tyrrhenian and Ligurian Seas and the eastern Adriatic, from where similar observations have been reported by Serena et al. (2000) and Soldo & Jardas (2002).

## MATERIAL AND METHODS

Records of basking sharks off the Maghreb shore were collected from literature data concerning the area and observations at fishing sites located along the Algerian and Tunisian coasts (Fig. 1). The former is divided into western, central and eastern areas and the latter into northern, central and southern areas.

Table 1 presents details of each record, sex (when

possible), total length (to the nearest mm), mass (to the nearest gram), capture depth (in metres), fishing gear, fishing site and the area either in Algerian or Tunisian waters, fishing date and reference. Fishing sites are plotted in figure 1 for Algerian records and in figure 2 for Tunisian records, the latter showing the captures made in the Gabès Gulf. Some body measurements were made on two specimens caught off the Algerian coast. They are detailed in Table 2. Body measurements *pro parte* follow Compagno (1984) and clasper length was measured on the inner edge of the clasper from the pelvic girdle to tip of clasper according to Collenot (1969).

## RESULTS AND DISCUSSION

Altogether, 21 records are presented in Table 1, 20 from the period between 1966 and 2002, and 12 since 1998. Record No. 21 is also presented in figure 3. Observations of fishes from both Algerian and Tunisian coastal waters began at the end of the 19<sup>th</sup> century according to the literature review included in Hureau & Monod (1973). Furthermore, research focusing exclusively on elasmobranch species was conducted thirty years ago off the Tunisian coast (Quignard & Capapé, 1971, 1972) and recently off the Algerian coast (Hemida, 1998; Hemida & Labidi, 2001). Since 1960, 39 specimens were reported by Serena et al. (2000) from the Tyrrhenian and Ligurian Seas, and 13 specimens by Soldo & Jardas (2002) from the eastern Adriatic.

In our case, males outnumbered females; sixteen specimens were males and only five were females (F/M=3.2:1). On the other hand, of the 24 specimens

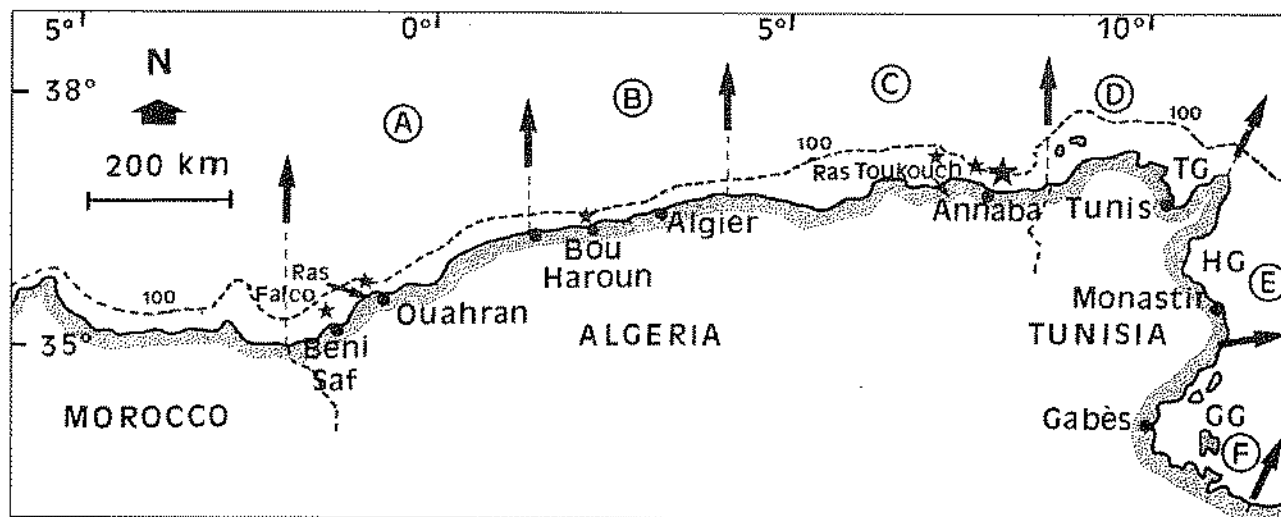

Fig. 1: Map of the Maghreb shore showing the *Cetorhinus maximus* fishing sites where a single specimen (small black stars) or two or more specimens (large black stars) were captured.

Sl. 1: Zemljevid maghrebskega obrežnega morja, kjer so bili ujeli morski psi orjaki *Cetorhinus maximus*: eden na lokalitetah, označenih z majhnimi črnimi zvezdicami ter dva ali več na lokaliteti, označeni z večjo črno zvezdico.

(among 47) sexed by Serena et al. (2000), 11 were males and 13 females (F/M = 1:1.18), while among 27 specimens, Soldo & Jardas (2002) reported the sex of four specimens, two males and two females.

In Table 1, total length ranged from 2700 to 7350 mm, but of the 14 measured specimens ten were over 4000 mm. Most of the measured specimens reported by Serena et al. (2000) and Soldo & Jardas (2002) were over 4000 mm long. They are large specimens and most of them were adult.

All the specimens from the Maghreb coastal waters were captured by pelagic fishing gear at depths of max. 30 m. According to Serena et al. (2000), only three specimens were found at depths between 70 and 200 m.

Twelve individuals were caught between March and August, and one in winter. Information provided by Algerian fishermen revealed that in the waters off Annaba (eastern Algeria, Fig. 1), basking sharks were exceptionally caught in spring and summer. These capture periods agree with those presented by Serena et al. (2000) for the Tyrrhenian and Ligurian Seas and Soldo & Jardas (2002) for the Adriatic. Serena et al. (2000) suggested that the occurrence of basking sharks was probably due to the increase in primary production and to the higher production of zooplankton. Soldo & Jardas (2002) added that this opinion requires a further and thorough investigation in the Adriatic Sea.

Nine specimens were caught off the Algerian coast and twelve off the Tunisian coast. All the fishing sites were in inshore waters, generally in more or less protected areas, such as Bays of Ouahran and Annaba along the Algerian coast. Decades ago, Dieuzeide et al. (1953) reported on the capture of a juvenile male with atypically curved nose at the end of 1929 and added that *C. maximus* was rather common off the coast of Algeria. After more than 70 years it appears that in spite of the great anthropogenic fishing pressures basking sharks are still caught in the area, although only as bycatch species.

Serena et al. (2000) suggested that the basking shark population inhabiting Tyrrhenian and Ligurian waters is an appropriate hypothesis. With regard to the previous papers and their own observations, Soldo & Jardas (2002) noted that 'the basking shark is a relatively rare but constant species in the Adriatic'.

Serena et al. (2000) added that the Mediterranean Sea could be also an important reproductive area for *C. maximus*, although they did not exclude the possibility that Atlantic migrants entered the Mediterranean through the Straits of Gibraltar. They emphasized that *C. maximus* was relatively more abundant in the eastern Atlantic Ocean than in the Mediterranean Sea. Barrull & Mate (1996, 2002) wrote that the basking shark was more often reported from the western Mediterranean than from its eastern part.

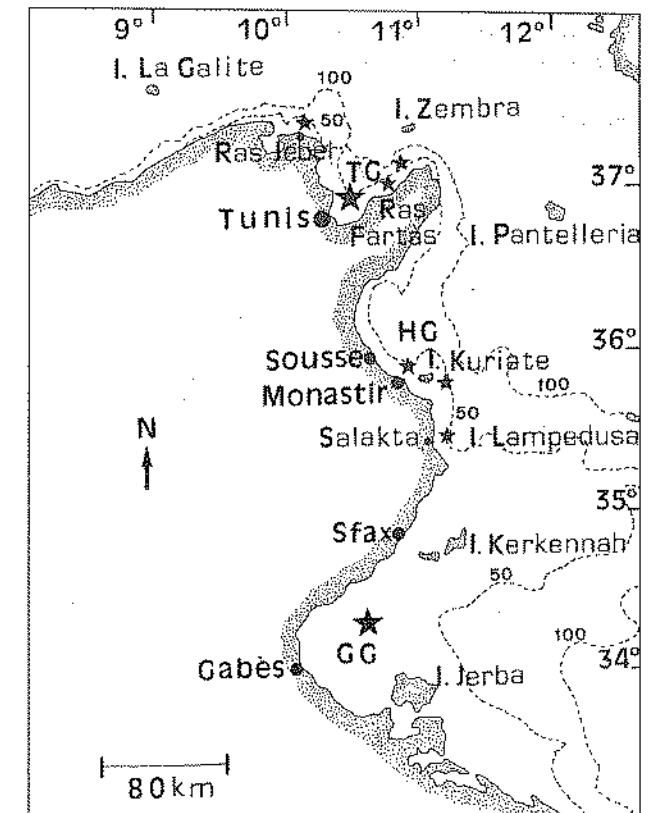

Fig. 2: Map of the Tunisian coast showing the *Cetorhinus maximus* fishing sites where a single specimen (small black stars) or two or more specimens (large black stars) were captured.

Sl. 2: Zemljevid tunizijskih obalnih voda, v katerih so ribiči ujeli morske pse orjake *Cetorhinus maximus*: enega na lokalitetah, označenih z majhnimi črnimi zvezdicami ter dva ali več na lokalitetah, označeni z večjimi črnimi zvezdicami.

Among the specimens recorded along the Maghreb shore, only the two reported from the western Algerian area could be considered Atlantic migrants. The other records were made in the region located between central Algerian and southern Tunisian coasts. Lipej et al. (2000) reported on the occurrence of *C. maximus* in the Gulf of Trieste, off Piran (northern Adriatic). The basking shark has also been recorded in the Levantin Basin (Golani, 1996) and, quite recently, in Turkish coastal waters in the Mediterranean by Kabasakal (2002), who wrote that 'it is not clear whether the occurrence of the basking in the seas of Turkey is incidental or exhibits a seasonal regularity'.

Our present observations speak in favour of the opinion presented by Soldo & Jardas (2002). Migrations from the eastern Atlantic certainly need to be confirmed. On the other hand it is difficult to state, at present, whether the basking shark population develops and re-



Tab. 1: Historical and recent records of *Cetorhinus maximus* off the Maghreb shore.Tab. 1: Starejši in novejši podatki o morskem psu orjaku *Cetorhinus maximus* iz obrežnih maghrebskih voda.

Record	Sex	TOT (mm)	Mass (kg)	Depth (m)	Capture method	Fishing site	Area	Fishing date	Reference
1	Male	3750	?	?	Gill-nets (?)	Ras Falcon	western Algeria	27/12/1929	Dieuzeide et al. (1953)
2	Male	?	?	?	?	Tunis Gulf	northern Tunisia	1964	Chakroun (1966)
3	Male	?	?	?	?	Tunis Gulf	northern Tunisia	1965	Chakroun (1966)
4	Male	5340	?	30 (?)	Pelagic trawl	Kuriate Islands	central Tunisia	03/1976	Capapé et al. (1975)
5	Male	6000	?	?	?	Tunis Gulf	northern Tunisia	1979	Najaï (1980)
6	Male	2700	?	?	?	Tunis Gulf	northern Tunisia	1980	Najaï (1980)
7	Female	6270	?	10 (?)	Pelagic trawl	Off Monastir	central Tunisia	1981	unpubl. data
8	Male	3500	332	5	Gill-nets	Ras Fartas (Tunis Gulf)	northern Tunisia	08/1981	unpubl. data
9	Female	7100	?	12	Pelagic gill-nets	Off Skhira (Gabès Gulf)	southern Tunisia	1992	Bradaï & Ghorbel (1992)
10	Female	?	?	5	Pelagic gill-nets	Off Annaba	eastern Algeria	19/04/1998	unpubl. data
11	Male	?	?	5	Pelagic gill-nets	Off Beni-Saf	western Algeria	08/05/1998	unpubl. data
12	Male	?	?	?	Pelagic gill-nets	Off Annaba	eastern Algeria	10/05/1998	unpubl. data
13	Male	7150	?	?	Gill-nets	Ras Jebel (Tunis Gulf)	northern Tunisia	1998	Rais & Baccar (1998)
14	Male	7370	?	3	Gill-nets	Gabès Gulf	southern Tunisia	29/12/1999	unpubl. data
15	Male	?	?	?	?	Off Salakta	central Tunisia	23/03/2000	unpubl. data
16	Male	4900	546	5	Pelagic trawl	Off Bou-Haroun	central Algeria	31/03/2000	unpubl. data
17	Female	3300	176	5	Pelagic trawl	Off Annaba	eastern Algeria	03/04/2000	unpubl. data
18	Male	>6000	1000	5	Pelagic trawl	Ras Toukouch	eastern Algeria	18/05/2000	unpubl. data
19	Female	?	?	5	Pelagic trawl	Ras Toukouch	eastern Algeria	18/05/2000	unpubl. data
20	Male	4250	?	?	Purse seine	Gabès Gulf	southern Tunisia	24/04/2001	unpubl. data
21	Male	>7000	1500	?	Pelagic trawl	Off Annaba	eastern Algeria	28/03/2002	unpubl. data

Tab. 2: Body measurements made on two *Cetorhinus maximus* caught off the Algerian coast.Tab. 2: Telesne mere dveh morskih psov orjakov *Cetorhinus maximus*, ujetih v tunizijskih obrežnih vodah.

Measurements (mm)	Record 16	Record 17
Total length	4900	3300
Snout to first dorsal fin	2020	1700
Snout to second dorsal fin	3600	2220
First dorsal height	520	350
Second dorsal height	150	100
Pectoral fin length	620	510
Pelvic fin length	390	260
Caudal fin length	1050	770
Snout to nostril	90	60
Mouth width	680	430
Internostril space	140	90
Snout to mouth	310	185
Clasper length	390	-

produces off the Maghreb shore or whether it only feeds in the area. However, as captures of basking sharks increased during the last ten years, both feeding and reproducing cannot be excluded in the area but need further observations.

Nevertheless, the belief that the Mediterranean Sea can be considered a potential reproductive area has been given a boost by records of the second Mediterranean filter feeding species, the devil ray *Mobula mobular*

reported by Capapé & Zaouali (1976), Bradaï & Capapé (2001) and Hemida et al. (2002a). Moreover, the ray is even considered a Mediterranean endemic species (Notarbartolo di Sciarra & Bianchi, 1998). In this area, these two species probably found sufficient resources to reproduce as well as to develop, just as other pelagic teleost fishes (Kartas, 1981; Chavance et al., 1986; Bradaï, 2000).

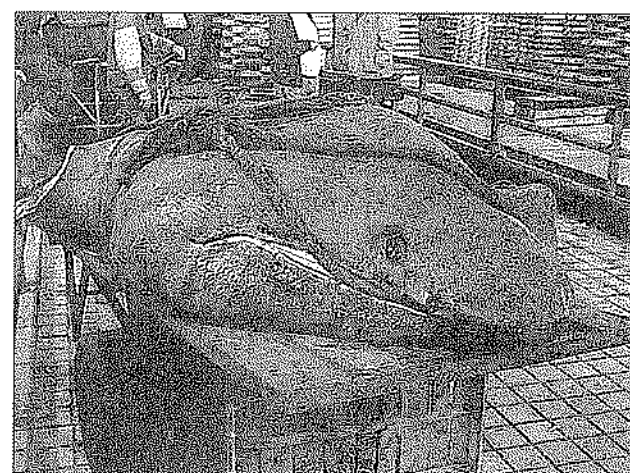

Fig. 3: Head of a male shark caught off Annaba, Algerian coast (for details see record 21 in Table 1). (Photo: F. Hemida)

Sl. 3: Glava samca, ujetega v bližini Annabe ob alžirski obali (o podrobnostih glej zapis št. 21 v tabeli 1). (Foto: F. Hemida)

POJAVLJANJE MORSKEGA PSA ORJAKA, *CETORHINUS MAXIMUS* (GUNNERUS, 1756) (CHONDRICHTHYES: CETORHINIDAE), V BLIŽINI MAGHREBSKEGA OBREŽJA (JUŽNO SREDOZEMLJE): PREGLED

Christian CAPAPÉ

Laboratoire d'Ichtyologie, Université Montpellier II, Sciences et Techniques du Languedoc, F-34 095 Montpellier cedex 05  
E-mail: capape@univ-montp2.fr

Farid HEMIDA &amp; Jalil BENSACI

Laboratoire Halieutique, Institut des Sciences de la Nature, Université des Sciences et Techniques Houari Boumediene, 16111 Bab Ezzouar, Alger, B. P. 32, El Alia, Algérie

Béchir SAÏDI &amp; Mohamed Nejmeddine BRADAÏ

Institut National des Sciences et Technologies de la Mer, Centre de Sfax, 3018 Sfax, B. P. 1035, Tunisie

## POVZETEK

V pričujočem prispevku avtorji navajajo starejše in novejšje podatke o ujetju morskih psov orjakov *Cetorhinus maximus* v bližini Maghrebskega obrežja (v alžirskih in tunizijskih vodah) in jih primerjajo s podatki o pojavljanju populacije teh morskih psov v drugih delih Sredozemskega morja.

**Ključne besede:** Chondrichthyes, Cetorhinidae, *Cetorhinus maximus*, Maghrebsko obrežje, Alžirija, Tunizija, Sredozemsko morje

## REFERENCES

- Barrull, J. & I. Mate (1996): Registros de tiburón peregrino (*Cetorhinus maximus*) en aguas del Mediterraneo. Bol. Asoc. Esp. Elasm., 2, 37-52.
- Barrull, J. & I. Mate (2002): Tiburones del Mediterraneo. El llibre del Set-ciències, Arenys del Mar, 292 pp.
- Bradaï, M. N. (2000): Diversité du peuplement ichthyologique et contribution à la connaissance des sparidés du golfe de Gabès. Ph.D. Thesis. University of Sfax, Tunisia, 600 pp.
- Bradaï, M. N. & C. Capapé (2001): Captures du diable de mer, *Mobula mobular* dans le golfe de Gabès (Tunisie méridionale, Méditerranée centrale). Cybium, 25 (4), 389-391.
- Bradaï, M. N. & M. Ghorbel (1992): Capture d'un requin pèlerin *Cetorhinus maximus* (Gunnerus, 1765) dans la région du golfe de Gabès, Tunisie. Bull. Inst. natn sci. tech. Océanogr; Pêche, Salammbô, 3, 10-15.
- Capapé, C. (1975): Sélaciens nouveaux et rares le long des côtes tunisiennes. Premières observations biologiques. Arch. Inst. Pasteur, 51(1-2), 107-128.
- Capapé, C. (1984): Nouvelles données sur la morphologie et la biologie de la reproduction de *Carcharhinus plumbeus* (Nardo, 1827) (Pisces, Carcharhinidae) des côtes tunisiennes. Inv. Pesq., 48(2), 115-137.
- Capapé, C. (1987): Propos sur les Sélaciens des côtes tunisiennes. Bull. Inst. natn sci. tech. Océanogr; Pêche, Salammbô, 14, 15-32.
- Capapé, C. (1989): Les Sélaciens des côtes méditerranéennes: aspects généraux de leur écologie et exemples de peuplements. Océanis, 15 (3), 309-331.
- Capapé, C., A. Chadli & R. Prieto (1975): Les Sélaciens dangereux des côtes tunisiennes. Arch. Inst. Pasteur, 53(1-2), 61-108.
- Capapé, C. & J. Zaouali (1976): Note sur la présence de la Mante de mer *Mobula mobular* (Bonaterre, 1788) (Sélaciens, Rajiformes) dans les eaux tunisiennes. Dorian, 5(223), 1-8.
- Chakroun, F. (1966): Capture d'animaux rares en Tunisie. Bull. Inst. natn sci. tech. Océanogr; Pêche, Salammbô, 1(2), 75-79.
- Collenot, G. (1969): Etude biométrique de la croissance relative des ptérygopodes chez la petite roussette *Scyliorhinus canicula* L. Cah. Biol. Mar., 10, 309-323.
- Compagno, L. V. J. (1984): FAO species catalogue. Vol. 4. Sharks of the world. An annotated and illustrated catalogue of shark species known to date. Part 1: Hexanchiformes to Lamniformes. FAO Fish. Synop., 125 (4), 1-249.
- Chavance, P., F. Chabane, F. Hemida, H. Korichi, M. P. Sanchez, J. L. Bouchereau, J. A. Tomasini & F. Djabali (1986): Evaluation du rendement par recrue relatif à partir de fréquences de taille: application à quelques stocks d'anchois, de sardinelles et de chinchards de la Méditerranée occidentale. CGPM, FAO Rapp. Pêches, (347): 186-204.



- Dieuzeide, R., M. Novella & J. Roland (1953):** Catalogue des Poissons des côtes algériennes. Bull. Stn. Aquic. Pêch. Castiglione (n.s.), 4, 1-135.
- Golani, D. (1996):** The marine ichthyofauna of the Eastern Levant. History, inventory and characterization. Israël J. Zool., 42, 15-55.
- Hemida, F. (1998):** The shark and skate fishery in the Algerian basin: biological and technological aspect. Shark News, 12, p. 14.
- Hemida, F. & N. Labidi (2001):** Nouvelle liste commentée des requins de la côte algérienne. Rapp. Comm. int. Mer Médit., 36, p. 273.
- Hemida, F. & C. Capapé (2002):** Observations on a female Bramble shark, *Echinorhinus brucus* (Bonnaterre, 1788) (Chondrichthyes: Echinorhinidae), caught off the Algerian coast (southern Mediterranean). Acta Adriat., 43(1), 103-108.
- Hemida, F., S. Mehezem & C. Capapé (2002a):** Captures of the giant devil ray, *Mobula mobular* Bonnaterre, 1788 (Chondrichthyes: Mobulidae) off the Algerian coast (southern Mediterranean). Acta Adriat., 43(2), 69-76.
- Hemida, F., R. Seridji, N. Labidi, J. Bensaci & C. Capapé (2002b):** New data on *Carcharhinus* spp. (Chondrichthyes: Carcharhinidae) from off the Algerian coast (southern Mediterranean). Acta Adriat., 43(2), 83-93.
- Hemida, F. & C. Capapé (2003):** Observations on blue sharks, *Prionace glauca* (L., 1758) (Chondrichthyes: Carcharhinidae), from the Algerian coast (southern Mediterranean). J. Mar. Biol. Ass. U. K., 83(4), 873-874.
- Hureau, J. C. & T. Monod (eds.) (1973):** Check-list of the fishes of the north-eastern Atlantic and of the Mediterranean (CLOFNAM). Vol. II. Bibliography. UNESCO, Paris.
- Kabasakal, H. (2002):** Capture of a female basking shark, *Cetorhinus maximus* (Gunnerus, 1765), from southern Turkey. Annales Ser. hist. nat., 12(1), 31-32.
- Kartas, F. (1981):** Les Clupéidés de Tunisie. Caractéristiques biométriques et biologiques. Etude comparée des populations de l'Atlantique et de la Méditerranée. Ph.D. Thesis, University of Tunis, Tunisia, 608 pp.
- Lipej, L., M. Makovec, M. Orlando & V. Žiža (2000):** Occurrence of the basking shark, *Cetorhinus maximus* (Gunnerus, 1765), in the waters off Piran (Gulf of Trieste, Northern Adriatic). Annales Ser. hist. nat., 10(2), 211-216.
- Najai S. (1980):** Note sur la présence de deux requins pélerins dans le golfe de Tunis. Bull. Inst. natn sci. tech. Océanogr; Pêche, Salammbô, 7, 151-152.
- Notabartolo di Sciarra, G. & I. Bianchi (1998):** Guida degli squali e delle razze del Mediterraneo. F. Muzzio Ed., Padova.
- Quignard, J. P. & C. Capapé (1971):** Liste commentée des Sélaciens de Tunisie. Bull. Inst. natn sci. tech. Océanogr; Pêche, Salammbô, 2(2), 131-141.
- Quignard, J. P. & C. Capapé (1972):** Complément à la liste commentée des Sélaciens de Tunisie. Bull. Inst. natn sci. tech. Océanogr; Pêche, Salammbô, 2(3), 445-447.
- Raïs, C. & F. Baccar (1998):** Compte-rendu de la visite effectuée pour examiner un requin de grande taille capturé à Ghar-El-Melh. Rapp. CAR/ASP, 1 p.
- Serena F., M. Vacchi & G. Notarbartolo di Sciarra (2000):** Geographical distribution and biological information on the basking shark, *Cetorhinus maximus* in the Tyrrhenian and Ligurian seas. Proc. 3<sup>rd</sup> Europ. Elasm. Assoc. Meet., Boulogne-sur-Mer, 1999. Séret, B & J. Y. Sire (eds.), Soc. Fr. Ichtyol. & IRD, Paris, p. 47-56.
- Soldo, A. & I. Jardas (2002):** Large sharks in the eastern Adriatic. Proc. 4<sup>th</sup> Europ. Assoc. Meet., Livorno (Italy), 2000. Vacchi, M., G. La Mesa, F. Serena & B. Séret (eds.) ICRAM, ARPAT & SFI, Paris, p. 147-155.

original scientific article  
received: 2003-07-10

UDK 597.5(262.3-12)

## ON THE RECORD OF MADEIRA ROCKFISH *SCORPAENA MADURENSIS* VALENCIENNES, 1833, IN THE EASTERN ADRIATIC

Jakov DULČIĆ, Armin PALLAORO & Sanja MATIĆ  
Institute of Oceanography and Fisheries, HR-21000 Split, P.O. BOX 500  
E-mail: dulcic@izor.hr

### ABSTRACT

A Madeira rockfish, *Scorpaena madurensis* Valenciennes, 1833, was caught near the island of Daksa (Dubrovnik) in March 2003. As far as the Madeira rockfish is concerned, this is, to our best knowledge, second record of this species for the eastern Adriatic. The presented morphometric and meristic data are the first for this species from the eastern Adriatic.

**Key words:** *Scorpaena madurensis*, second record, eastern Adriatic

## TESTIMONIANZA DI SCORFANOTTO DI MADEIRA *SCORPAENA MADURENSIS* VALENCIENNES, 1833 IN ADRIATICO ORIENTALE

### SINTESI

Un esemplare di scorfanotto di Madeira, *Scorpaena madurensis* Valenciennes, 1833, è stato catturato vicino all'isola di Daksa (Ragusa) nel marzo del 2003. Secondo le conoscenze degli autori, si tratta della seconda testimonianza della presenza dello scorfanotto di Madeira nell'Adriatico orientale. L'articolo riporta i primi dati morfometrici e meristici per questa specie in Adriatico orientale.

**Parole chiave:** *Scorpaena madurensis*, Adriatico orientale, seconda segnalazione



INTRODUCTION

Some 430 fish species and subspecies (Cyclostomata not included) have been observed in the Adriatic Sea (Lipej & Dulčić, *in press*), and this number can be so far regarded as correct and complete for several reasons. Of this number, the very rare and rare fishes make up almost a quarter (24.2%). The Madeira rockfish *Scorpaena madurensis* belongs to the very rare species in the Adriatic Sea (Jardas, 1985, 1996). It is a small demersal fish found in shallow coastal waters at depths ranging from 20 to 40 m (Schneider, 1990). It occurs in the eastern Atlantic (Azores, Madeira, and Morocco to the Canaries, Cape Verde and Senegal) and at several localities in the Mediterranean Sea (Schneider, 1990).

The records on biology and ecology of this species in the areas of distribution and in the Adriatic Sea are scarce in the literature. Hureau & Litvinenko (1986) noted that the Madeira rockfish feeds on crustaceans and small fishes. Vacchi *et al.* (1999) presented data about the occurrence and habitat of juveniles and adults at Ustica Island (Mediterranean Sea), while Morato *et al.* (2001) reported the parameters of length-weight relationship of this species for the Azores archipelago. There are no data for the Adriatic Sea, except the notation of the first record for the eastern Adriatic (Kolombatović, 1904).

The main goal of this paper is to present first data on morphometric and meristic characteristics of this species and to register its second record for the eastern Adriatic.

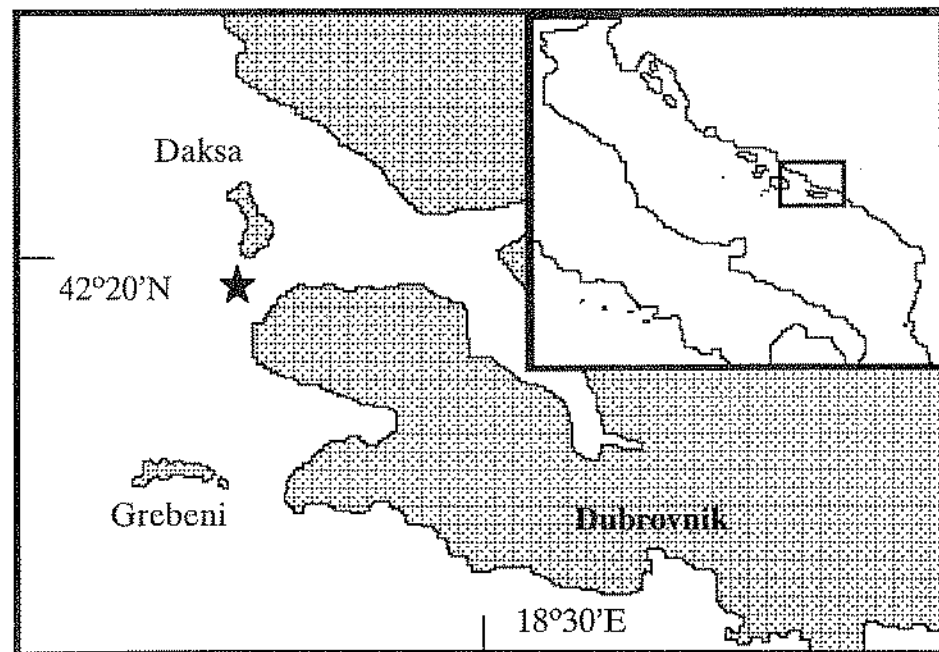

Fig. 1: *Scorpaena madurensis*. Geographic location of the record in the South Adriatic area (SW-S Daksa Islet).  
Sl. 1: Lokacija v Jadranu, kjer je bila ujeta *Scorpaena madurensis* (JZ-J otoček Daksa).

MATERIAL AND METHODS

The Madeira rockfish was caught on March 15<sup>th</sup> 2003 near the island of Daksa (near Dubrovnik) (Fig. 1) by trammel bottom net (mesh size 28 mm) at a depth of 24 m (on the littoral rocky bottom). The specimen (juvenile stage, female) (Fig. 2) was identified according to Jardas (1996). It is deposited and registered in the Ichthyological Collection of the Institute of Oceanography and Fisheries in Split, Croatia. The specimen was preserved in 4% buffered formaldehyde immediately after capture, subsequently measured to nearest 0.01 mm, and weighed to the nearest 0.01 g. Meristic characteristics considered were: dorsal, anal, pectoral, ventral and caudal fins.

RESULTS AND DISCUSSION

The record of the Madeira rockfish near Daksa Island (Dubrovnik) is the second record of this species in the eastern Adriatic. Kolombatović (1904) recorded *S. madurensis* (he identified the specimen as *Sebastes maderensis* Lowe) (total length TL = 130 mm) for the first time on August 3<sup>rd</sup> near the island of Lastovo (open Central Adriatic) in 1902. The same author mentioned that some specimens had already been found near Malaga (Spain), Beirut (Lebanon) and along the coast of Syria. *S. madurensis* is a poorly known species distributed on the littoral rocky bottoms of some areas of the Mediterranean Sea, such as southeastern Spain, Sicily,

Greece (Ionian and South Aegean) and Lebanon (Tortonese, 1975; Kaspiris, 1976; Economidis & Daoulas, 1981; Lanfranco, 1993). Hureau & Litvinenko (1986) referred to several localities in the Mediterranean where the Madeira rockfish occurs: southeastern coast of Spain, Strait of Messina, Syracuse and coast of Lebanon. It is very interesting that they excluded the Adriatic Sea as its distribution area.

Tab. 1: *Scorpaena madurensis*. Morphometric (in cm) and meristic data (Daksa Island, Dubrovnik, March 2003).

Tab. 1: *Scorpaena madurensis*. Morfometrični (v cm) in meristični podatki (otoček Daksa, Dubrovnik, marec 2003).

Measurements (cm)	♀ juv.
Total length (TL)	11.31
Standard length (SL)	8.72
Head length (HL)	3.71
Orbital diameter (O)	0.91
Interorbital width (IO)	0.43
Preorbital length (PROL)	0.85
Postorbital length (POOL)	1.95
Predorsal distance (PDD)	2.55
Preventral distance (PVD)	3.75
Preanal distance (PAD)	6.49
Prepectoral distance (PPD)	3.07
Dorsal fin length (DL)	5.16
Anal fin length (AL)	1.04
Ventral fin length (VL)	2.71
Pectoral fin length (PL)	2.51
Caudal fin length (CL)	2.56
Maximum height (Hmax)	3.03
Caudal peduncle height (Hmin)	0.89
Dorsal ray (D)	XI/10
Anal ray (A)	III/5
Pectoral ray (P)	15
Ventral ray (V)	I/5
Caudal ray (C)	II-11-II

In Table 1, the main morphometric and meristic data are presented and are the first for this species from the Adriatic Sea. They are in agreement with those presented by Hureau & Litvinenko (1986) and Jardas (1996). Kolombatović (1904) reported the length of 130 mm of the caught Madeira rockfish at the Lastovo Island, and this has been, until now, the only reported length of this species caught in the eastern Adriatic. Bini (1968) pointed that this species attains a maximum size of 14 cm, while Morato *et al.* (2001) gave length range for the specimens caught at the Azores from 5.4 to 17.8 cm (males: from 8.4 to 17. cm; females: from 6.9 to 15.6 cm).

The specimen caught near Daksa was caught on the littoral rocky bottom together with photophilic algae, which is very much in line with the findings of Vacchi *et al.* (1999). They observed specimens on hard substrate, both on rocky bottoms with photophilic algae, rich in crevices and with different slope, and, to a lesser extent, on hard bottom with pebbles characterised by gentle slope (Ustica Island, Northern coast of Sicily). Moreover, they also found that both young and adults seemed to require the same habitat features. Riera *et al.* (1995) reported that littoral crevices and cavities along the shallow waters (0.8-15 m depth) represent the preferred habitat of this species. As for the bottom slope, it does not seem to affect the distribution of specimens and, in terms of ecological requirements, no difference between young and adults has been found (Riera *et al.*, 1995). Bini (1968) considered it preferentially inhabits the rocky coasts of the islands between 20 and 40 m depth.

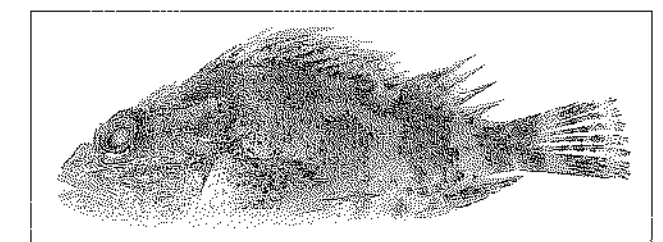

Fig. 2/Sl. 2: *Scorpaena madurensis* Valenciennes, 1833. (Photo/Foto: A. Pallaoro).



O VRSTI *SCORPAENA MADURENSIS VALENCIENNES*, 1833,  
UJETI V VZHODNEM JADRANU

Jakov DULČIĆ, Armin PALLAORO & Sanja MATIĆ  
Inštitut za oceanografiju in ribištvo, HR-21000 Split, P.O.BOX 500

## POVZETEK

Marca 2003 je bila v bližini otočka Daksa pri Dubrovniku ujeta *Scorpaena madurensis Valenciennes*, 1833. Po razpoložljivi literaturi je to šele drugi podatek za to vrsto v vzhodnem Jadranskem morju. Predstavljeni morfološki in meristični podatki so prvi za to vrsto iz vzhodnega Jadrana.

**Ključne besede:** *Scorpaena madurensis*, drugi podatek, vzhodni Jadran

## REFERENCES

- Bini, G. (1968):** Atlante dei Pesci delle Coste Italiane. Vols. V, VI. Mondo Somerso, Milano.
- Economidis, P. S. & H. K. Daoulas (1981):** The Scorpionfishes (Pisces, Scorpaenidae) of the North Aegean Sea. Bull. Mus. natl. Hist. nat., Paris, 4 ser., 3, section A, no. 4, 1219-1224.
- Hureau, J.-C. & N. I. Litvinenko (1986):** Scorpaenidae. In: Whitehead, P. J. P., M.-L. Bauchot, J.-C. Hureau, J. Nielsen & E. Tortonese (eds.). Fishes of the North-eastern Atlantic and the Mediterranean. UNESCO, Paris, Vol. 3, 1211-1229.
- Jardas, I. (1985):** Check-list of the fishes (*sensu lato*) of the Adriatic Sea (Cyclostomata, Selachii, Osteichthyes) with respect of taxonomy and established number. Biosistematika, 1, 45-74.
- Jardas, I. (1996):** Jadranska ihtiofauna. Školska knjiga, Zagreb, 533 pp.
- Kaspiris, P. (1976):** New fish records from the Greek part of the Ionian Sea. Rev. Trav. Inst. Peches marit., 40, 627-628.
- Kolombatović, J. (1904):** Contribuzioni alla fauna dei vertebrati della Dalmazia. Glas. hrv. narav. društva, 15, 182-191.
- Lanfranco, G. G. (1993):** The fish around Malta (Central Mediterranean). Progress Press, Malta, 132 pp.
- Lipej, L. & J. Dulčić (in press):** Fish diversity – what is new in the Adriatic Sea? In: Griffiths, H. I., B. Kryštufek & J. M. Reed (eds.). Balkan Biodiversity. Pattern and Process in Europe's Biodiversity Hotspot. Kluwer Academic Publishers B.V.
- Morato, T., P. Alfonso, P. Lourinho, J. P. Barreiros, R. S. Santos & R. D. M. Nash (2001):** The length-weight relationships for 21 coastal fish species of the Azores, north-eastern Atlantic. Fish. Res., 50, 297-302.
- Riera, F., A. M. Grau, E. Pastor & S. Pou (1995):** Faunistic and demographical observations in balearic ichthyofauna. Meridization or subtropicalization phenomena. In: Actes Colloque sci. "La Méditerranée: Variabilités climatiques, Environnement et Biodiversité". Montpellier, France, p. 213-220.
- Schneider, W. (1990):** FAO species identification sheets for fishery purposes. Field guide to the commercial marine resources of the Gulf of Guinea. Prepared and published with the support of the FAO Regional Office for Africa. FAO, Rome, 268 pp.
- Tortonese, E. (1975):** Osteichthyes (Pesci Ossei). Parte seconda. Fauna d'Italia, vol. XI. Calderini, Bologna, 636 pp.
- Vacchi, M., M. Boyer, S. Bussotti, P. Guidetti & G. La Mesa (1999):** Some interesting species in the coastal fish fauna of Ustica Island (Mediterranean Sea). Cybium, 4, 323-331.

MORSKA BIOLOGIJA IN EKOLOGIJA

BIOLOGIA ED ECOLOGIA MARINA

MARINE BIOLOGY AND ECOLOGY

original scientific article  
received: 2003-03-17

UDK 639.4:574.6(262.3-18)

ESTIMATING THE CARRYING CAPACITY OF COASTAL AREAS  
POTENTIALLY SUITABLE FOR MUSSEL CULTURE  
IN THE UPPER ADRIATIC, CROATIA

Barbara SLADONJA

Institute for Agriculture and Tourism, HR-52440 Poreč, P.O. Box 31

E-mail: barbara@iptpo.hr

Radovan ERBEN, Ivana MAGUIRE, Goran KLOBUČAR & Jasna LAJNER  
Department of Zoology, Faculty of Science, University of Zagreb, HR-10000 Zagreb, Rooseveltov trg 6

ABSTRACT

*This paper deals with the application of a carrying capacity model, designed to evaluate the suitability of ten coastal inlets situated on islands in the upper Adriatic Sea for mussel production, and to estimate a potential production quantity. This approach allowed the estimation of a potential carrying capacity of the researched stations and suggestions for a possible launch of mussel production in these areas. The results of this study are considered to be useful for the management of coastal areas suitable for bivalve farming, especially in this particular case of island development. It has been established that the model was suitable for evaluation and that all selected stations have good conditions and carrying capacity for mussel production. Mussel farming could, therefore, improve the island economy.*

**Key words:** carrying capacity, mussel farming, dimensioning of mussel farms, island development, Croatia

VALUTAZIONE DI AREE COSTALI POTENZIALMENTE IDONEE ALLA MITILICOLTURA  
NEL NORD ADRIATICO, CROAZIA

SINTESI

*L'articolo tratta l'applicazione del modello di capacità portante destinato alla valutazione dell'idoneità alla mitilicoltura di dieci insenature costali situate su isole del Nord Adriatico e alla stima della quantità di produzione potenziale. L'approccio permette la valutazione della capacità portante potenziale delle stazioni studiate, nonché la formulazione di proposte per un possibile lancio della mitilicoltura in tali aree. I risultati del presente studio vengono considerati vantaggiosi per la gestione delle aree costali idonee alla coltura di bivalvi, in particolare nell'ambito dello sviluppo insulare. Il modello si è rivelato adatto alla valutazione e tutte le stazioni prescelte hanno dimostrato di avere condizioni e capacità portanti favorevoli alla mitilicoltura. La coltura di mitili pertanto potrebbe migliorare l'economia insulare.*

**Parole chiave:** capacità portante, mitilicoltura, dimensionamento di mitilicolture, sviluppo insulare, Croazia



## INTRODUCTION

The coast of Croatia and especially its islands have a number of areas potentially suitable for sea organism farming. Seashell farming has a long tradition on the eastern Adriatic coast, probably dating from the Roman period, but the first written documents originating from the 16<sup>th</sup> century describe Mali Ston Bay. In the 20<sup>th</sup> century, seafood farming intensified on over 30 localities from Slovenian coast down to Boka Kotorska Bay (Basioli, 1981). Former seafood production (during the Austro-Hungarian Empire) was much higher than today. The Austrian Fishery and Mariculture Society used several locations on the coast and islands for oyster and blue mussel culture (Quinto Congresso generale della Società Austriaca di Pesca e piscicoltura marina, 1893). One of the main social and economical problems in Croatia today is maintaining the population on the islands and revitalising the economy. Aquaculture could be one of the main economy branches on the islands and on the coast in general.

Aquaculture is characterised by great dependence on the quality and productivity of the environment. Its development also bears a risk of negative environmental impact, such as pollution, landscape modification, or biodiversity change. Aquaculture development needs to follow the rules for use and conservation of natural resources in aquatic ecosystems (Bussani, 1983). Aquaculture as a renewable resource is a capital that must ensure a sustainable flow of benefits to users.

Coastal zones are always subjects of different conflicting needs, which include recreational and tourist requirements, navigational access and traditional commercial fishing rights. Optimisation of available space is consequently a challenge that also faces the developing aquaculture industry.

Few mussel species are farmed all around the world. The world production in 2000 exceeded 1.5 million. More than 20 countries have significant production, although only two of them dominate the market, i.e. China with 40% of the total world production and Spain with 20%.

On the eastern Adriatic coast, the majority of shell production is located in Mali Ston Bay (90% of total production), with other larger farms situated in Lim Bay, Piran Bay, mouth of the river Krka, and Budava Bay (Hrs-Brenko, 1985). In 1984, 300 t of mussels, 40 t of oysters and 260 t of blue mussels were produced in Mali Ston Bay (Benović, 1980, 1997). Considering the natural features of our coast, it could be said that the seafood production is still far from possible and satisfactory.

The most farmed mussels are those belonging to the genus *Mytilus* (*M. edulis* - blue mussel), while the genus *Perna* (former green mussel) is farmed in warmer waters, as around Thailand, China or New Zealand.

The capacity at the Gulf scale depends on primary

production, trophic relationships, and modification of bio-geochemical cycles and community structure in the vicinity of culture sites (Foster-Smith, 1975; Fréchette & Bourget, 1985; Fréchette et al., 1991, 1992).

On a smaller scale, however, the possibility of local food depletion should be considered. In many coastal ecosystems, bivalve suspension feeders, such as mussels, oysters and clams, occur in high densities. Feeding is performed by pumping and filtering large volumes of water through gills. Due to the filtration activity by bivalves, depletion of organic matter, bacteria and phytoplankton in the overlying water has been observed in various ecosystems (Möhlenberg & Riisgård, 1979; Wright et al., 1982; Mantoura & Llewellyn, 1983; Fréchette & Bourget, 1985). Indeed, dense arrays of long lines are likely to lead to a depletion of seston (Loo & Rosenberg, 1989), which could affect the optimal size of growing sites, a problem that has been considered by Incze et al. (1981). In addition, local depletion of seston raises the issue of determining the optimal distance between the sites, as they should be positioned in such a way to enable water replenishment by mixing and plankton growth before reaching next downstream site.

Early attempts to assess the impact of shellfish aquaculture focused on the issue of carrying capacity, or the ability of the system to support shellfish production were made (Incze et al., 1981; Loo & Rosenberg, 1989). More recently, the emphasis has been on modelling the impact of shellfish (Rodhouse & Roden, 1987).

A carrying capacity model has been tested by applying it to ten island bays in the upper Adriatic. The model is based on particle and not on energy flow. The main objective was to test the model, and to apply it in specific conditions of the chosen bays.

A three-season field programme was undertaken to assess the spatial and periodical distribution of total and organic seston and transport mechanisms of water and seston in the vicinity of a site. These terms of the seston budget were used to determine the dominant processes involved, and thus to evaluate the possibility of launching mussel farming.

## MATERIALS AND METHODS

## Location

The study was carried out in the upper Adriatic Sea, on four Croatian islands. Ten potentially suitable stations for mussel farming were investigated (Fig. 1):

- Cres Island: Pogana Bay (st. 1),
- Krk Island: Puntarska draga (st. 2) and Sofine Bay (st. 3),
- Rab Island: St. Eufemija Bay (st. 4), Kamporska draga (st. 5), Lopar Bay (st. 6) and Supetar Bay (st. 7),
- Pag Island: Caska Bay (st. 8), Stara Novalja Bay (st. 9), and Stara Poveljana Bay (st. 10).

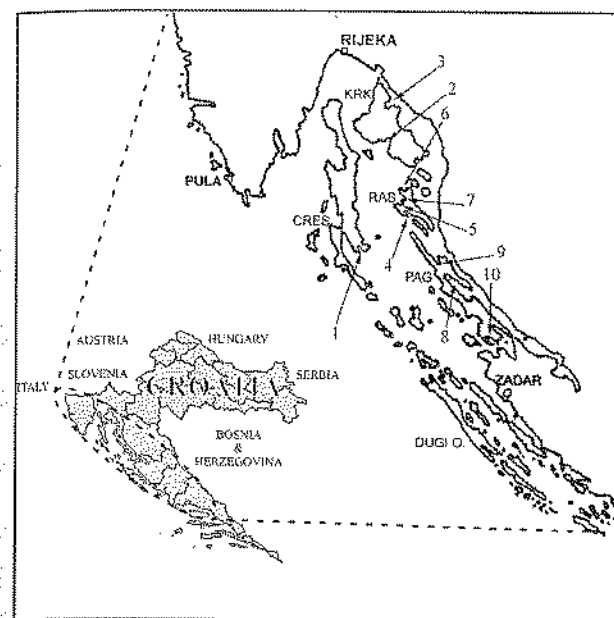

Fig. 1: Ten investigated stations along Croatian islands potentially suitable for mussel farming.  
Sl. 1: Deset raziskanih vzorčišč vzdolž hrvaških otokov, potencialno primernih za školjkarstvo.

## Sampling

Sampling took place in the winter (February) of 1998, and in the summer (July) and autumn (December) of 1999. Three replicates of water samples were taken at 0.5 and 10 m using a 5 l Niskin bottle. Currents were measured by a pseudo-eulerian method using Andria's cross (Mosetti, 1979). Compass recorded the direction.

## Methods

Total particulate matter or seston (TPM) and particulate organic matter (POM) was determined as triplicates in the Zoology Department of the Faculty of Science.

Samples for seston analysis in triplicates of 250 ml were filtrated on combusted and pre-weighted Whatman GF/F filters. The filters were transferred to a 60°C drying oven for 24 hours. On the following day, filters were weighted to obtain values of TPM and combusted at 450 to 500°C for 24 h and re-weighted to estimate particulate inorganic matter (PIM) and POM (Magazzù, 1984). We used standard statistic equations (standard deviation and t-test).

Filtration rate is defined as the rate of removal of particles from a suspension in which the animals feed, or a measure of the equivalent volume of water that must have been filtered to account for the rate of removal (Coughlan, 1969; Foster-Smith, 1975; Meyhöfer, 1985; Prins et al., 1994; Riisgård, 2001). We used literature data for calculating the filtration rate. In Table 1, values

of blue mussel filtration rates are presented. Finally, we used the average filtration rate for the blue mussel.

Food supply is a function of water movement and quantity of particles in the water, whereas food demand is a function of filtration rate and food concentration. Carrying capacity is calculated by dividing food supply with food demand.

Tab. 1: Data of mussel filtration rate from bibliography.  
Tab. 1: Podatki iz bibliografije o hitrosti filtracije školjk.

Mussel filtration rate (l/h)	Bibliographic source
2.06	Foster-Smith (1975)
0.33-1.25 (0.79)	Foster-Smith (1975)
0.35-1.05 (0.7)	Foster-Smith (1975)
1.54	Foster-Smith (1975)
1.47	Foster-Smith (1975)
1.2-3.4 (2.3)	Schulte (1975)
0.5-2.0 (1.25)	Möhlenberg & Riisgård (1979)
1-2.5 (1.75)	Widdows et al. (1979)
2.50	Martinčić (1998)
<b>1.60</b>	<b>average value</b>

The modelling approach itself has shown certain weaknesses, including sensitivity to a restricted set of underlying assumptions and insensitivity to a potentially wide array of unspecified parameters. Despite these numerous limitations, approximations of carrying capacities for intensive cultivation remain of interest. The salient feature of both models is that it is based on particle flow, and not on energy flow. Clearly, the limitations of the modelling approach are not eliminated by these simplifications. This model is offered as an approach, and not as a unique solution.

The model is based on water movements and on the seston quantity in the area. A biological concept of the carrying capacity can be defined as the stock density at which production levels are maximized, without a negative environmental impact. The carrying capacity model studied here is based on balance between mussel nutritive needs and food supply within the system. The estimation of the carrying capacity of bivalves in open systems is rendered difficult due to several factors: 1) seasonal and size-related changes in the energy demands of the cultured organisms; 2) seasonal changes in the abundance and nature of potential food substrates found in natural waters; 3) general lack of knowledge concerning the degree to which bivalves utilize various particles in the seston, and 4) difficulties of quantifying mixing and flow through most culture areas.

The model of Carver & Mallet (1990) was developed in Canada (Nova Scotia). Authors used a somewhat simplistic but practical approach to determine estimates of carrying capacity for a mussel operation in a semi-closed coastal inlet on the Atlantic coast. Rather than

relying on laboratory-derived values, authors obtained extensive field data on water exchange, food levels and *in situ* mussel filtration rates. The volume of the Basin was estimated as well as the volume of water flowing in and out of the system in each tidal cycle. Data of suspended particulate matter was used in order to calculate food levels (food supply and food demand). Finally, carrying capacity was obtained dividing food supply by food demand. Equations are presented in Table 4.

## RESULTS AND DISCUSSION

### Environmental study

Current velocities are shown in Table 2. As expected, the strongest currents were measured in winter as a consequence of meteorological conditions. We did not find significant differences between stations.

Measurements of the currents gave us results comparable with other authors (Princi *et al.*, 1980; Stravisi & Battista, 1992). Two current types are usually present in the Adriatic (Mosetti, 1966). On a large scale, there is a constant slow current below 10 m depth, parallel to the coast in the northern direction. On a small scale, currents are influenced by wind, tide and morphological circumstances. It is important for good water quality in mussel farms to have fast water exchange and currents able to replenish the water quite frequently.

The biggest bay is Caska on Pag Island, while the smallest is Pogana on Cres Island. As far as the bay volume is concerned, the largest goes to St. Poveljana Bay on Pag, and the smallest to Punat Bay on Krk. In Table 4, all hydrologic data about bays is presented (water tidal oscillations, water surface and volume, water exchange).

Water exchange in all examined bays showed good results (from 5-30% of water exchange/day). For example, the Gulf of Trieste that is known for its high number of mussel farms (Martinčić, 1998) has an average water exchange of only 7%. The bay studied by Carver & Mallet (1990) had a water exchange of approx. 50%. This is particularly important for water replenishment that depends not only on tidal currents but also on permanent currents and also imports from the land.

Temperature, salinity and oxygen are parameters closely linked with each other and connected with external meteorological and hydrological conditions. Their variations are mostly of temporal character. During winter, the water column is homogeneous due to strong water mixing, while in spring it is possible to observe water stratification, which continues into and through the entire summer (Marchetti & Cotta Ramusino, 1992). Stratification is present both for temperature (presence of thermocline) and salinity (pycnocline). In spring, superficial water in fact heats up, and due to the freshwater income from the land the salinity varies greatly between the sea's surface and floor.

Tab. 2: Current velocities at sampling stations.  
Tab. 2: Hitrosti tokov na vzorčiščih.

Stations	Winter	Summer	Autumn
1	9.5	15.2	0.07
2	0.6	12.5	10.0
3	5.9	0.9	0.9
4	18.0	14.7	8.3
5	12.8	16.7	0.1
6	26.3	16.7	8.3
7	10.2	9.5	10.5
8	12.5	7.1	14.9
9	15.0	8.3	8.3
10	0.3	0.3	0.3

Analysis of TPM showed a maximum concentration of particulate matter in summer (Tab. 3). Considering the low depth of water at most stations, high TPM values are probably a consequence of bottom resuspension. The obtained data were not significantly different between stations.

The relatively high standard deviations can be explained with the fact that these values are calculated as an average of three depths (0, 5 and 10 m). These are depths at which mussels are farmed and although different they were not statistically significant. For further calculations, we thus decided to work with average data.

The lowest POM concentration was recorded in winter, the highest in autumn. Differences between winter and summer as well as between winter and autumn are statistically significant (t-test = 0.000828, t-test = 0.002804), while those between summer and autumn are not significant (t-test = 0.285358). All the examined stations had a good quantity of POM, ranging between 1.2 mg/l (Lopar and St. Novalja Bays) and 4.2 mg/l in St. Poveljana Bay.

TPM is related to land contributions and also to phytoplankton production (Schulte, 1975; Valli, 1980; Fonda Umani & Ghirardelli, 1988; Williams & Claustre, 1991). Suspended matter is usually composed of inorganic detritus, especially close to the shore or in shallow waters. Even by taking this into consideration, we found some relatively high concentrations of organic matter, with values ranging from 14% (winter) to 77% (autumn) of POM. Bayne & Widdows (1978) recorded, for the coastal area of Spain, values from 3 to 100 mg/l of TPM, with only 5-30 % of organic components. Our results can be well compared to data measured in the Gulf of Trieste (Adriatic Sea). Authors measured from 0.7 to 4 mg/l of TPM, with 25 to 31% of organic matter (Fonda Umani & Ghirardelli, 1988).

Since the organic component is formed by live planktonic organisms and organic products of biodeposition, it is normal that we found the lowest concentration of organic matter in winter, when no planktonic

Tab. 3: Mean values ( $\pm$ s.d.) of total particulate matter (TPM) and particulate organic matter (POM) during three seasons at ten sampling stations. Relative contribution of POM as % of TPM is also shown.

Tab. 3: Srednje vrednosti ( $\pm$ s.d.) celotne suspendirane snovi (TPM) in partikulatne organske snovi (POM) v treh sezonah na desetih preučevanih vzorčiščih. Prikazan je tudi relativni prispevek POM kot % TPM.

Station	Winter			Summer			Autumn		
	TPM (mg/l)	POM (mg/l)	POM (% of TPM)	TPM	POM	POM (% of TPM)	TPM	POM	POM (% of TPM)
1	3.3 (1.0)	0.4 (0.3)	14.0 (11.5)	4.1 (1.7)	2.6 (0.8)	68.0 (20.7)	3.5 (0.9)	2.0 (0.3)	60.0 (11.0)
2	3.4 (1.4)	0.9 (0.1)	28.7 (8.1)	3.3 (1.0)	2.2 (0.5)	69.0 (7.5)	3.8 (1.7)	1.5 (0.9)	39.7 (15.6)
3	3.9 (0.8)	1.2 (0.1)	31.0 (2.8)	6.3 (3.3)	3.0 (1.2)	48.0 (22.3)	3.5 (1.1)	1.3 (5.7)	37.0 (15.5)
4	17.8 (20.5)	1.7 (1.1)	18.0 (10.5)	7.4 (2.0)	1.8 (0.9)	25.3 (12.5)	3.0 (1.8)	2.1 (0.7)	75.3 (15.9)
5	3.0 (1.6)	0.5 (0.3)	17.3 (4.2)	4.3 (2.9)	1.9 (0.6)	49.7 (13.7)	2.6 (1.0)	2.0 (0.7)	76.7 (4.2)
6	4.8 (4.0)	0.7 (0.0)	21.0 (13.1)	4.1 (2.3)	1.7 (0.7)	47.3 (15.3)	7.0 (5.8)	1.3 (0.5)	22.3 (8.1)
7	3.8 (1.4)	0.8 (0.4)	22.0 (6.9)	4.3 (1.9)	1.8 (0.3)	44.7 (11.7)	2.6 (0.6)	1.2 (0.2)	48.3 (19.5)
8	6.8 (4.8)	1.6 (0.8)	25.0 (5.6)	7.1 (4.0)	3.9 (1.1)	62.0 (17.1)	3.4 (1.1)	1.7 (0.6)	50.3 (4.5)
9	3.0 (0.7)	1.1 (0.3)	35.7 (7.8)	2.6 (0.3)	1.3 (0.4)	50.3 (19.8)	2.9 (0.4)	1.1 (0.4)	36.7 (7.5)
10	2.3 (0.6)	0.5 (0.1)	22.0 (7.8)	18.0 (6.5)	4.2 (1.3)	23.0 (9.8)	2.8 (1.3)	1.8 (6.0)	64.0 (25.3)

blooms are present, and the highest percentage in autumn due to the active planktonic bloom or senescent phase of the bloom (Marchetti & Cotta Ramusino, 1992).

### Carrying capacity model

There is an abundance of data in literature on the influence of water flow on the particles or food concentration (Dame *et al.*, 1980; Incze *et al.*, 1981; Cloern, 1982; Fréchette & Bourget, 1985; Loo & Rosenberg, 1989).

In estuaries, the seston movement is dominated by the river outflow, while in the coastal inlets it is primarily determined by tidal currents, which are often very weak. Food supply in the water depends not only on the water flow but also on the quantity and quality of particles present in it (Zentilin & Pellizzato, 1996).

Variations in food supply are in relation to tidal oscillations and thus to tidal volume, as well as to POM oscillations in the water. We observed that maximum POM levels at our stations were comparable to the values reported in other mussel studies (Bayne & Widdows, 1978; Widdows *et al.*, 1979; Wildish & Kristmanson, 1984; Carver & Mallet, 1990). Values lower than 1 mg/l are common along the Atlantic coast, while higher values are generally characteristic of estuaries and coastal inlets (Carver & Mallet, 1990). The lowest food supply was noted for the wintertime, as a result of the low primary production.

Among the stations, we calculated the highest quantity of food supply in Caska and St. Poveljana Bays on Pag Island.

Rodhouse & Roden (1987) found that zooplankton compete with cultured mussels for food particles and

estimated that herbivorous zooplankton consume 29% of the annual phytoplankton production in Killary Harbour, Ireland. On the other hand, recent evidence suggests that mussels can significantly reduce microzooplankton levels (Incze *et al.*, 1981), thereby effectively decreasing food competition. Given that increasing stock densities have a positive effect on primary production, our estimates of food supply should eventually include not only the POM delivered to the system, but also locally produced POM.

Food demand was calculated with estimates on filtration rate and food concentration. At our sites, there were always enough particles present in the water to satisfy the average filtration needs by mussels. Mussels consume live and inorganic particles in the water (plankton and detritus).

Since we did not find significant differences in carrying capacities measured in winter, summer and autumn, average data is presented (Tab. 4). In the end, we concentrated on potential differences between stations.

Relatively large water volumes and high POM concentrations gave high carrying capacities. St. Novalja and St. Poveljana Bays had a carrying capacity higher than 2000 t. The lowest carrying capacity was calculated for Pogana (about 600 t).

In estimating the carrying capacity, we assumed that the mussels had access to 100% of the available food supply. This approach does not allow factors such as incomplete mixing of particles in the Gulf, loss of particles in the outflow, and contamination of "new" particle-rich water by "old" particle-depleted water from the previous tidal cycle. A positive effect of mussel stock densities on nutrient regeneration, which can enhance local primary production, should also be considered.



Tab. 4: Carrying capacity equations and hydrological data for the ten sampling stations.  
Tab. 4: Enačbe za izračun nosilnosti okolja in hidrološki podatki za deset vzorčičišč.

Parameter	Equation	Cres	Krk	Krk	Rab	Rab	Rab	Rab	Pag	Pag	Pag	
		st. 1	st. 2	st. 3	st. 4	st. 5	st. 6	st. 7	st. 8	st. 9	st. 10	
a	Average ebb tide (cm)	32.2	32.2	32.2	32.2	32.2	32.2	32.2	32.2	32.2	32.2	
b	Average high tide (cm)	30.3	30.3	30.3	30.3	30.3	30.3	30.3	30.3	30.3	30.3	
c	Daily oscillations (cm)	(a+b) x 2	125	125	125	125	125	125	125	125	125	
d	Tidal volume per day (x 10 <sup>4</sup> m <sup>3</sup> )	c x i	201	377	430	320	463	271	560	1398	675	1030
e	Tidal volume per week (x 10 <sup>4</sup> m <sup>3</sup> )	d x 7	1407	2644	3016	2246	3244	1903	3920	9789	4731	7211
f	Bay volume in ebb tide (x 10 <sup>4</sup> m <sup>3</sup> )	j-d/2	1217	878	1106	2344	9732	2426	6274	11487	10683	15714
g	Bay volume in high tide (x 10 <sup>4</sup> m <sup>3</sup> )	j+d/2	1418	1255	1537	2665	10196	2697	6834	12886	11359	16745
h	Water exchange per day (%)	d/g	14	30	28	12	5	10	8	11	6	6
i	Total by surface (A <sub>tot</sub> ) m <sup>2</sup>		1609300	3024209	3449123	2569200	3710500	2176800	4482500	11194100	5410100	8245700
j	Bay volume (V <sub>tot</sub> ) x 10 <sup>4</sup> m <sup>3</sup>		1318	1067	1322	2505	9964	2562	6554	12187	11021	16230
k	POM (mg/l)		1.7	2.6	2.4	1.9	1.5	1.2	1.3	2.4	1.2	4.2
l	Food supply (x 10 <sup>6</sup> g POM/week)	e x k	23.4	68.4	72.4	42.0	47.6	23.4	49.4	233.2	55.1	202.1
m	Food demand (g POM/kg mussels/week)	k/1000 x 1.6 x 24h x 7 x 83	37.2	57.3	53.5	41.6	32.7	27.5	28.3	53.5	26.0	62.5
	Carrying capacity (tons of mussels)	l/m	629	1193	1353	1010	1456	851	1746	4359	2119	3234

All the sites have shown to be suitable for mussel production. Carrying capacities higher than 500 t can be considered as high. The lowest recorded carrying capacity was in Pogana Bay on the island of Cres (600 t). Generally, the best island for mussel production should be Pag, where all three bays showed very high carrying capacities (higher than 2000 t).

#### CONCLUSIONS

It can be concluded that all the examined sites on Croatian islands are suitable for mussel farming. The present study only confirmed this statement already known to national experts. Mariculture could be an ad-

ditional motive and way of earning money for these island populations, as well as incentive for new people settling there.

Among 10 sites, the best are those on the island of Pag, but none turned out to be non-suitable for mussel farming. Similar study should be performed on other islands and new locations for this economic activity suggested.

#### ACKNOWLEDGEMENTS

The project was financially supported by the Croatian Ministry for Public Works and Reconstruction.

## OCENJEVANJE NOSILNOSTI OKOLJA V SEVERNOJADRANSKIH OBALNIH OBMOČJIH, POTENCIALNO PRIMERNIH ZA VZGOJO ŠKOLJK

Barbara SLADONJA

Institute for Agriculture and Tourism, HR-52440 Poreč, P.O. Box 31

E-mail: barbara@iptpo.hr

Radovan ERBEN, Ivana MAGUIRE, Goran KLOBUČAR & Jasna LAJTNER  
Department of Zoology, Faculty of Science, University of Zagreb, HR-10000 Zagreb, Rooseveltov trg 6

#### POVZETEK

V desetih manjših zalivih ob severnojadranskih otokih je bil uporabljen model za ugotavljanje nosilnosti takojšnjega morskoga okolja. Študija, katere namen je bil ugotoviti primernost teh voda za gojenje školjk, je slonela na terenskih podatkih o izmenjavi vode in količini hrane v njej, dobljenih med vzorčenjem pozimi, poleti in jeseni leta 1999.

Rezultati so pokazali, da so vse preučevane lokalitete primerne za školjkarstvo. Najnižja nosilnost okolja je bila ugotovljena v zalivu Pogana na Cresu, sicer pa je bila izmenjava vode zadostna v vseh preučevanih zalivih (od 5-30% na dan).

Dobljene rezultate bi lahko uporabili za upravljanje obalnih območij, primernih za vzgojo školjk, posebno v primerih načrtovanega otoškega razvoja. Školjkarstvo bi lahko seveda močno izboljšalo otoško gospodarstvo.

**Ključne besede:** nosilnost okolja, školjkarstvo, dimenzioniranje školjčičišč, otoški razvoj, Hrvaška

#### REFERENCES

- Basioli, J. (1981): Uzgoj školjkaša na istočnoj obali Jadranskog mora s posebnim osvrtom na Malostonski zaljev. Zbornik radova savjetovanja "Malostonski zaljev prirodna podloga i društveno valoriziranje", Dubrovnik, 1981, str. 268-282.
- Bayne, B. L. & J. Widdows (1978): The physiological ecology of two populations of *Mytilus edulis* L. *Oecologia*, 37, 137-162.
- Benović, A. (1980): Razvoj marikulture u kanalu Malog Stona. *Morsko ribarstvo*, 32(1), 26-28.
- Benović, A. (1997): The history, present condition, and future of the molluscan fisheries of Croatia. NOAA Tech. Rep. NMFS, 129, p. 217-226.
- Bussani, M. (1983.): Guida pratica di mitilicoltura. Edagricole, Bologna.
- Carver, C. E. A. & A. L. Mallet (1990): Estimating the carrying capacity of a coastal inlet for mussel culture. *Aquaculture*, 88, 39-53.
- Cloern, J. E. (1982): Does the benthos control phytoplankton biomass in South San Francisco Bay? *Mar. Ecol. Prog. Ser.*, 9, 191-202.
- Coughlan, J. (1969): The estimation of filtering rate from the clearance of suspension. *Mar. Biol.*, 2, 356-358.
- Dame, R. F., R. Zingmark, H. Stevenson & D. Nelson (1980): Filter feeding coupling between the estuarine water column and benthic subsystems. In: Kennedy, V.S. (ed): *Estuarine Perspectives*. Academic Press, New York, p. 521-526.
- Fonda Umani, S. & E. Ghirardelli (1988): Caratteristiche chimiche e biologiche del sistema pelagico del Golfo di Trieste. *Hydrores*, V(6), 71-82.
- Foster-Smith, R. L. (1975): The effects of concentration of suspension on the filtration rates and pseudofaecal production for *Mytilus edulis* L., *Cerastoderma edule* (L.) and *Venerupis pullastra* (Montagu). *J. Exp. Mar. Biol. Ecol.*, 17, 1-22.
- Fréchette, M. & E. Bourget (1985): Energy flow between the pelagic and benthic zones: factors controlling particulate organic matter available to an intertidal mussel bed. *Can. J. Fish. Aquat. Sci.*, 42, 1158-1165.
- Fréchette, M., D. A. Booth, B. Myrand & H. Bérard (1991): Variability and transport of organic seston near a mussel aquaculture site. *ICES Mar. Sci. Symp.*, 192, 24-32.
- Fréchette, M., A. E. Aitken & L. Pagé (1992): Interdependence of food and space limitation of a benthic suspension feeder: consequences for self - thinning relationships. *Mar. Ecol. Prog. Ser.*, 83, 55-62.

- Hrs-Brenko, M. (1985):** Marikultura. Pomorski zbornik, 23(1), 217-236.
- Incze, L. S., R. A. Lutz & E. True (1981):** Modeling carrying capacities for bivalve molluscs in open, suspended-culture systems. J. World Maric. Soc., 12(1), 143-155.
- Loo, L. O. & R. Rosenberg (1989):** Bivalve suspension-feeding dynamics and benthic-pelagic coupling in an eutrophicated marine bay. J. Exp. Mar. Biol. Ecol., 130, 253-273.
- Magazzù, G. (1984):** Metodi di analisi per acque di mare. Materiale in sospensione. Metodo gravimetrico. Quad. Ist. Ric. Acque, 59.
- Mantoura, R. F. C. & C. A. Llewellyn (1983):** The rapid determination of algal chlorophyll and carotenoid pigments and their breakdown products in natural waters by reverse-phase high-performance liquid chromatography. Anal. Chim. Acta, 151, 297-314.
- Marchetti, R. & M. Cotta Ramusino (1992):** Ecologia. Atti V Congresso Nazionale della Società Italiana di Ecologia, Milano, 21-25 Settembre 1992.
- Martinčić, B. (1998):** Modello di carrying capacity applicato alle mitilocolture in sospensione. Ph.D. thesis. Università degli studi di Firenze, Pisa e Udine, p. 15-108.
- Meyhöfer, E. (1985):** Comparative pumping rates in suspension-feeding bivalves. Mar. Biol., 85, 137-142.
- Möhlenberg, F. & H. U. Riisgård (1979):** Filtration rate, using a new indirect technique, in thirteen species of suspension-feeding bivalves. Mar. Biol., 54, 143-148.
- Mosetti, F. (1966):** Considerazioni preliminari sulla dinamica dell'Adriatico Settentrionale. Arch. Oceanogr. Limnol., 15 (Suppl.), 237-244.
- Mosetti, F. (1979):** Fondamenti di Oceanologia e Idrologia. Unione Tipografica - Editrice Torinese, Torino, p. 458-475.
- Princi, M., F. Stravisi & M. Specchi (1980):** Osservazioni morfologiche, fisiche e chimiche sulla Baia di Muggia (Golfo di Trieste - Alto Adriatico). Mem. Biol. Mar. Oceanogr., 10 (Suppl.), 275-284.
- Prins, T. C., N. Dankers & A. C. Smaal (1994):** Seasonal variation in the filtration rates of a semi-natural mussel bed in relation to seston composition. J. Exp. Mar. Biol. Ecol., 176, 69-86.
- Riisgård, H. U. (2001):** On measurements of filtration rates in bivalves – the stony road to reliable data: review and interpretation. Mar. Ecol. Prog. Ser., 211, 275-291.
- Rodhouse, P. G. & C. M. Roden (1987):** Carbon budget for a coastal inlet in relation to intensive cultivation of suspension - feeding bivalve molluscs. Mar. Ecol. Prog. Ser., 36, 225-236.
- Schulte, E. H. (1975):** Influence of algal concentration and temperature on the filtration rate of *Mytilus edulis*. Mar. Biol., 30, 331-341.
- Stravisi, F. & G. Battista (1992):** Correntometria costiera nel Golfo di Trieste. Rapporto Interno LC 92/4. Laboratorio di Climatologia, Dipartimento di Fisica Teorica, Università degli Studi di Trieste.
- Valli, G. (1980):** Riproduzione ed accrescimento di alcune specie di molluschi eduli nelle Lagune di Grado e marano. Nova Thalassia, 4(Suppl.), 49-65.
- Widdows, J., P. Fieth & C. M. Worrall (1979):** Relationships between seston, available food and feeding activity in the common mussel *Mytilus edulis*. Mar. Biol., 50, 195-207.
- Wildish, D. J. & D. D. Kristmanson (1984):** Importance to mussels of the benthic boundary layer. Can. J. Fish. Aquat. Sci., 41, 1618-1625.
- Williamson, R. & H. Claustre (1991):** Photosynthetic pigments as biomarkers of phytoplankton populations and processes involved in the transformation of particulate organic matter at the Biotrans site (47°N, 20°W). Deep-Sea Res., 38(3), 347-355.
- Wright, R. T., R. B. Coffin, C. P. Ersing & D. Pearson (1982):** Field and laboratory measurements of bivalve filtration of natural marine bacterioplankton. Limnol. Oceanogr., 27(1), 91-98.
- Zentilin, A. & M. Pellizzato (1996):** La molluschicoltura in Italia. Atti XX Convegno Nazionale sui Problemi della Pesca e dell'Acquicoltura, Cesenatico, 11-12 ottobre 1996, p. 113-119.

review  
received: 2003-03-10

UDK 591.9:574.5(262.3-18)

## MEIOBENTHIC FAUNA (WITHOUT HARPACTICOIDA) IN THE SOUTHERN PART OF GULF OF TRIESTE, SLOVENIA: LIST OF TAXA

Borut VRISER

National Institute of Biology, Marine Biology Station, SI-6330 Piran, Fornače 41

E-mail: vriser@mbss.org

### ABSTRACT

The article presents an integral systematic review of meiobenthic fauna (without the already presented Copepoda Harpacticoida), arranged on the basis of extensive material gathered in the course of numerous investigations during the last 30 years in the southern part of the Gulf of Trieste. The emphasis is on a systematic survey, which includes a total of 30 higher taxa with nearly 180 species, although still a minor part of all expected but undiscovered species of the area.

**Key words:** meiofauna, list of taxa, Gulf of Trieste, Slovenia

## FAUNA MEIOBENTONICA (ESCLUSI GLI ARPACTICOIDI) DELLA PARTE MERIDIONALE DEL GOLFO DI TRIESTE, SLOVENIA: LISTA DEI TAXA

### SINTESI

L'articolo presenta una revisione sistematica integrale della fauna meio bentonica (esclusi i copepodi arpacticoidi già presentati), preparata in base al vasto materiale raccolto durante le numerose ricerche effettuate negli ultimi 30 anni nella parte meridionale del Golfo di Trieste. Posta in rilievo l'indagine sistematica che include 30 taxa superiori con quasi 180 specie, benché queste rappresentino solo una piccola parte di tutte le specie attese ma ancora sconosciute dell'area.

**Parole chiave:** meiofauna, lista dei taxa, Golfo di Trieste, Slovenia



## INTRODUCTION

The paper presents meiofauna of the southern part of Gulf of Trieste, Copepoda excluded. The present work is a continuation of the survey of meiobenthos in the Slovene sea (initiated several years ago), with an emphasis on its species structure and spatial distribution. In the first two articles (Vrišer, 2000a, b), the systematics and ecology of harpacticoid copepods (Copepoda, Harpacticoida) as one of the most dominant groups were presented, while the aim of this paper is to outline the taxonomic structure of the remaining meiofauna.

Meiobenthos of the southern part of Gulf of Trieste has so far not been researched at such level as already mentioned harpacticoid copepods. The extent of more complete taxonomic determinations is here incomparably poorer. Amongst the causes for such state of affairs we must highlight, apart from a truly exceptional bulk of the material itself, mainly the following very specific and excusable reasons:

1. in many groups, particularly in those that are sparse or with more delicate body structure, taxonomic study would require some very special and to them adapted sampling techniques and substantially greater number of parallel samples, as well as often repeated seasonal sampling;

2. even today, many groups remain poorly researched, with insufficient, outdated or hardly accessible literature;

3. lack of suitable specialists or taxonomic consultants;

4. predominantly juvenile character of several groups (temporary meiofauna, *i.e.* juvenile stages of the future macrofauna), which greatly aggravates precise identification of species;

5. damaged body structures of the more delicate, especially "worm-like" groups owing to the use of routine methods of fauna extraction from the substrate, which are more or less unsuitable for these particular groups;

6. incompatibility of the necessary (stated) specific methodological approaches with simultaneous demands of general ecological studies of the great spatial or temporal frequency span.

In spite of it all, a fairly clear structural and ecological picture has crystallised from the research lasting for more than thirty years, which in many groups reached a notable degree of a systematic rounding up. The research into some methodologically exceptionally demanding taxa unfortunately remained at its initial stage (e.g. Nemertinea, Nematoda, Oligochaeta, if mentioning only the most abundant ones) and is still waiting to be continued.

We believe that in spite of the above-mentioned gaps, fauna other than copepod, too, would deserve its first presentation of a clearer although for the time being still unavoidably preliminary systematic survey.

## MATERIAL AND METHODS

Most of our samplings were implemented with gravity core sampler (Meischner & Rumohr, 1974); only in lagoonar conditions they were also carried out manually, always with three parallel samples in the surface sediment of 10 cm<sup>2</sup>, 5-10 cm deep. Meiofauna was extracted with the sieving-decantation technique according to Wieser (1960) on 1 mm, 0.125 mm, and 0.050 mm sieves, preserved (4% formalin with seawater), sorted out, counted and, if at all possible, identified to its species.

Only a minor part of the meiofauna groups was taxonomically analysed by specialists: Foraminifera (Franc Cimerman, Slovenian Museum of Natural History, Ljubljana), Polychaeta (Andrej Avčin, Marine Biology Station Piran, National Institute of Biology, Ljubljana), Tanaidacea (Dušan Zavodnik, Centre for Marine Research, Rudjer Bošković Institute, Rovinj), Insecta (Ignac Sivec, Slovenian Museum of Natural History, Ljubljana), Bryozoa (Brian M. Marcotte, Clark University, Worcester, USA).

For taxonomic determination, authentication and classification of all remaining groups stated in brackets below, the author used the following important references:

Bartsch & Illiffe, 1985 (Acarina); Bonaduce *et al.*, 1975 (Ostracoda); Bouillon & Grohmann, 1990 (Hydrozoa); Chevreux & Fage, 1925 (Amphipoda); De Min & Vio, 1997 (Gastropoda, Bivalvia); Gruner, 1965 (Isopoda), Higgins, 1977 (Kinorhyncha); Hulings, 1971 (Hydrozoa, Kinorhyncha); Karaman, 1972, 1973, (Amphipoda); Klie, 1938 (Ostracoda); Nordsieck, 1968, 1972 (Gastropoda), 1969 (Bivalvia); Platt & Warwick, 1983, 1988 (Nematoda); Riedl, 1956 (Turbellaria), 1983 (Anthozoa, Cirripedia, Decapoda, Cumacea, Lepidostrea, Sipunculida, Chaetognatha, Holothurioidea, Asteroidea, Ophiuroidea, Echinoidea, Ascidiacea, Nemertinea); Rieger, 1971 (Turbellaria); Salvini-Plawen, 1966 (Hydrozoa); Sars, 1896 (Isopoda).

## ECOLOGICAL CHARACTERISTICS OF THE RESEARCHED ENVIRONMENT

The so far carried out research into the meiofauna of southern Gulf of Trieste has dealt with the entire depth span of these waters: from 0.3-5 m in coastal studies, to the samplings in the Gulf's open waters (19-30 m depth). Meiofauna of the four coastal sampling profiles (1-15 m) in the Bays of Koper, Strunjan and Piran was comparatively researched in the summer and winter months, while the meiofauna of deeper areas was studied only in the summer.

Thermic conditions of the entire area range from 9-21 °C, with average salinity of 37.5 psu, oxygen content in the span of 55-96% saturation, except in the very rare

periods of hypoxia crisis, when the values can fall below 40%.

With the exception of some marginal coastal localities (Koper and Piran Bays), which were at the time of sampling still under a great impact of organic pollution of urban origin, all the remaining meiofauna dealt with in this paper belonged to a clean and unburdened environment.

The substrate of the investigated area consists of clayey silt (10-20% clay), which along the coast gradually turns into silty clays (up to 25% of clay) and, towards the open sea, into fine sands (Ogorelec *et al.*, 1991).

## TAXONOMIC EXTENT OF RESEARCH INTO THE MEIOFAUNA OF SOUTHERN GULF OF TRIESTE

Taxonomic structure of meiofauna of the selected research area has in fact never been studied purposely (with the exception of harpacticoid copepods), at least not exclusively with this aim, for the emphasis was largely on the ecological complexities and typology of its associations. Although subordinate, it still was a component part of these investigations, whose selection, arranged according to the thematic criterion, is here presented only in a condensed form.

In Slovenia, the first ecological meiobenthic research was initiated by Marcotte & Coull (1974) on the coastal profile of Piran Bay. This research was followed by the author's investigations in the experimental basins of Strunjan (Vrišer, 1979, 1982), on the coastal profiles of the Bays of Koper, Strunjan and Piran (Vrišer, 1983-84, 1986), in the open waters of Gulf of Trieste (Vrišer, 1989, 1991, 1992), in the Bays of Strunjan and Izola (Vrišer, 1999, 2001), and in coastal lagoons (Vrišer, 2002).

At first, *i.e.* until the mid-1980s, the investigations were still directed at utterly ecological objectives, dealing primarily with the impacts of pollution on the meiofauna's associations. Nonetheless, these works contributed most of the taxonomic data presented herewith. To a smaller extent they were supplemented by the long-term studies of seasonal dynamics and meiofauna's long-term oscillations in the centre of Gulf of Trieste (Vrišer, 1996, 1997; Vrišer & Vukovič, 1999), as well as of its recolonisation characteristics (Vrišer, 1998; Vrišer & Vukovič, 2000).

There are unfortunately no other studies that would have contributed to a clearer picture of the systematic structure of the meiofauna in the southern part of Gulf of Trieste, but let us mention numerous investigations of separate groups of this fauna on at least three sites in the immediate vicinity of our waters, which are due to their closeness of a considerable significance for as well.

The first such site is situated close to Trieste (Italy): it is in fact the site of the former marine biology station,

where the first meiobenthic determinations were made in the early 20<sup>th</sup> century – e.g. Grünspan (1908) with the group Gastrotricha.

The second such site is the area around Rovinj (Croatia), where numerous investigations were made in the 1950s and 1960s by a number of taxonomists, such as Riedl (1956) (group Turbellaria), Sterrer (1965, 1967) (group Gnathostomulida), Schrom (1966a) (group Gastrotricha) and Salvini-Plawen (1966, 1968) (groups Cnidaria, Kamptozoa, Aculifera).

The third interesting site is the area around Venice, where much research was carried out by Schrom (1966b, c), Hummon *et al.* (1990) and Evans *et al.* (1993), all concentrating on the group Gastrotricha, and by Rieger (1971) (group Turbellaria).

Here follows a survey of all 31 registered higher taxa of the researched meiofauna, arranged in systematic succession (Riedl, 1983). Only some of the groups and species from the list are planktonic, all the rest being benthic.

For each group, an approximate estimate of their occurrence in our sea is stated, *i.e.* their quantitative representativeness (% relative abundance within total meiofauna, hereinafter referred to as rel. ab.) and an estimate of their systematic covering, *i.e.* of the suppositional and actually established number of species in the area researched. All estimates about the probable number of species stated in further text thus refer exclusively to meiofauna. For within the same groups the number of macrobenthic species can be here and there not only higher but also lower than in the meiofauna, *i.e.* by spatially variable share (number of species) of that particular meiofauna's component, which in contrast to the juvenile macrofauna does not surpass, not even in the adult stage, the size of 1mm (permanent meiofauna). However, the precise number of these species in the majority of dominant groups of our meiofauna is still not known.

## FORAMINIFERA

Foraminifera, which are no doubt part of meiofauna, are by most meiofaunists omitted from their research for methodological reasons. Namely, with the standard methods of colouring, suitable for the remaining fauna, it is not possible to distinguish between live and dead foraminiferous individuals. Foraminifera can thus be subject of only specialised sampling techniques, extraction, colouring, separation and particularly identification.

**Occurrence:** massive. If taken into account, foraminifera would be one of the first three dominant groups of meiofauna. **Number of species:** no actual data at hand. All 13 determined species from our list are from the Strunjan lagoon.

## HYDROZOA

**Occurrence:** rare, more common only here and there, generally below 0.1% rel. ab. **Number of species:** unknown, perhaps up to 10 species. 5 species determined partially.

## ANTHOZOA

**Occurrence:** only a few fragments of juvenile individuals were registered, presumably from the group of Anthipatharia. **Number of species:** unknown.

## TURBELLARIA

**Occurrence:** mass group in most samples, 1% rel. ab. **Number of species:** presumably up to 50, almost all of them permanently meiobenthic. 7 species determined partially.

## NEMERTINEA

**Occurrence:** rare, below 0.2% rel. ab. **Number of species:** unknown, no determinations.

## NEMATODA

**Occurrence:** most abundant, dominant group (70% rel. ab.) throughout in all samples! **Number of species:** unknown, possibly up to 100, almost exclusively permanent meiobenthic species. Only 4 less common species determined.

## KINORHYNCHA

**Occurrence:** common group, 0.25% rel. ab. **Number of species:** about 10 species of permanent meiofauna, 8 partial determinations.

## POLYCHAETA

**Occurrence:** third most abundant group (8% rel. ab.). **Number of species:** unknown, perhaps up to 100 species, to a great extent of temporary character (juvenile macrofauna), 38 species registered and in most cases determined.

## OLIGOCHAETA

**Occurrence:** very abundant group (2% rel. ab.). **Number of species:** unknown, perhaps few dozen species. No species determined.

## OSTRACODA

**Occurrence:** common group, mostly with low abun-

dances (0.25% rel. ab.). **Number of species:** unknown, perhaps over 50 species. 16 species registered and partially determined in our samples.

## CIRRIPEDIA

Only two coincidentally caught juvenile individuals.

## DECAPODA

**Occurrence:** rare, generally below 0.1% rel. ab. **Number of species:** perhaps up to 20 species, 10 more common species partially identified.

## AMPHIPODA

**Occurrence:** modest, in places somewhat more common, generally below 0.1% rel. ab. **Number of species:** perhaps up to 30 species, 14 more common species partially identified.

## ISOPODA

**Occurrence:** rare individuals, generally below 0.1% rel. ab. **Number of species:** unknown, 13 species partially determined.

## MYSIDACEA

**Occurrence:** rare, mostly occurring individually, altogether below 0.1% rel. ab. **Number of species:** unknown, 4 species partially identified.

## CUMACEA

**Occurrence:** rare, mostly occurring individually, altogether below 0.1% rel. ab. **Number of species:** perhaps above 10 species, 4 only partially determined.

## TANAIDACEA

**Occurrence:** rare, mostly occurring individually, generally below 0.1% rel. ab. **Number of species:** 4, with 3 of them identified.

## LEPTOSTRACA

A single identified individual.

## ACARINA

**Occurrence:** rare, mostly occurring individually, generally below 0.1% rel. ab. **Number of species:** perhaps up to 10 species, with 4 of them identified only partially.

## INSECTA

Some rare and in only at two localities found dipteran larvae (family Chironomidae) of unknown number of species.

## SIPUNCULIDA

A single and only partially determined individual.

## GASTROPODA

**Occurrence:** common, although not massive, usually with a few individuals per sample. Altogether 0.30% rel. ab. **Number of species:** unknown, possibly over 100 species. Only 10 species partially identified.

## BIVALVIA

**Occurrence:** massive, even with a few dozen individuals per sample. Altogether 0.25% rel. ab. **Number of species:** unknown, possibly over 100 species, with only 9 partially determined.

## BRYOZOA

Some rare individuals, 1 partially identified species.

## CHAETOGNATHA

Two coincidentally caught planktonic individuals of the same species.

## HOLOTHURIOIDEA

Some rare juvenile individuals, 3 partially identified species.

## ASTEROIDEA

Some rare juvenile individuals, 1 identified species.

## OPHIUROIDEA

**Occurrence:** all over the research area. Individual juveniles, only 1 species determined.

## ECHINOIDEA

Some rare individual larvae of unknown number of species.

## ASCIDIACEA

Some rare larvae.

At the end of taxonomic survey of our meiofauna, a question might be raised, where to place, in view of its species diversity, the area researched, if looking at potentially similar parts of the near and far neighbourhood. No comparable surveys can unfortunately be traced, while any serious diversity evaluation of our data is rendered very difficult by at this moment still highly inadequate systematic extent of research into the dominant, abundant and species-rich groups, such as Nematoda, Oligochaeta, Nemertinea, Polychaeta, Gastropoda and Bivalvia. Much work is thus still waiting for the future taxonomists, for the species determinations carried so far have probably reached less than a third of their presumed total number.

In spite of the stated taxonomic gaps, we could venture a judgment – on the very basis of the existing facts – that along with harpacticoid copepods (130 species) the fauna presented in this paper (180 species) also significantly contributes to the high diversity of our coastal waters.

## LIST OF SPECIES

With the exception of harpacticoid copepods, the list presents all till now registered taxonomic groups of meiofauna in the area researched. They are arranged according to the already mentioned system, i.e. in compliance with the available degree of their systematic analysis. This, however, can be only at the level of the higher taxa (e.g. ordo, classis, subclassis, familia), or it is determined down to the level of genus and species. The different species within the same taxon are either indicated as undetermined number of species (spp.) or are differentiated and numbered (*genus* sp. 1, sp. 2, etc.). Complete species determinations were given where at all possible.

## FORAMINIFERA

*Ammonia beccarii* (L.) - smooth  
*Ammonia beccarii* (L.) - ornamented  
*Ammonia* sp. 1  
*Criboelphidium* sp. 1  
*Eggerella advena* Cushman  
*Elphidium crispum* (L.)  
*Elphidium* sp. 1  
*Milionella* sp. 1  
*Quinqueloculina* sp. 1  
*Rosalina globularis* d'Orbigny  
*Sigmoilina cf. costata* Schlumberger  
*Triloculina laevigata* d'Orbigny  
*Trochammina inflata* (Montagu)

## HYDROZOA

*Siphonohydra* sp. 1  
*Halammohydra* sp. 1



<i>Halammohydra</i> sp. 2	<i>Lumbrineris</i> spp.
<i>Pinushydra</i> sp. 1	<i>Magelona</i> sp. 1
<i>Psammohydra</i> sp. 1	<i>Maldane glebifex</i> Grube
ANTHOZOA	<i>Micronephthys</i> sp. 1
Anthipatharia gen. spp.	Nereidae gen. sp. 1
TURBELLARIA	Nereidae gen. sp. 2
<i>Allostoma</i> sp. 1	<i>Notomastus</i> sp. 1
<i>Convoluta convoluta</i> Abild	<i>Notomastus</i> sp. 2
<i>Nemertoderma</i> spp.	<i>Onuphis</i> sp. 1
<i>Diopisthoporus</i> spp.	<i>Owenia fusiformis</i> delle Chiaje
<i>Mecynostomum</i> spp.	<i>Paraonis lyra</i> Southern
<i>Paraphanostoma</i> spp.	<i>Proxillella</i> sp. 1
<i>Plagiostomum</i> sp. 1	<i>Proxillella</i> sp. 2
NEMERTINEA	<i>Proxillella</i> sp. 3
Heteronemertini gen. spp.	<i>Prionospio cirrifera</i> Wiren
Hoploneimertini gen. spp.	<i>Prionospio malmgreni</i> Claparede
NEMATODA	Sabellidae gen. spp.
<i>Cyatholaimus</i> sp. 1	<i>Scolelepis fuliginosa</i> (Claparede)
<i>Desmoscolex</i> sp. 1	<i>Sphaerosyllis</i> sp. 1
<i>Enoplus</i> sp. 1	Spionidae gen. spp.
<i>Euchromadora striata</i> (Eberth)	Spirorbinae gen. spp.
KINORHYNCHA	Syllidae gen. sp. 1
<i>Echinoderes</i> sp. 1	Syllidae gen. sp. 2
<i>Echinoderes</i> sp. 2	Syllidae gen. sp. 3
<i>Neocentrophyes</i> sp. 1	<i>Terebellides stroemi</i> Sars
<i>Pycnophyes</i> sp. 1	OLIGOCHAETA
<i>Pycnophyes</i> sp. 2	Enhydraeidae gen. spp.
<i>Pycnophyes</i> sp. 3	OSTRACODA
<i>Trachydemus</i> sp. 1	<i>Callistocythere adriatica</i> Masoli
<i>Trachydemus</i> sp. 2	<i>Callistocythere</i> sp. 1
POLYCHAETA	<i>Callistocythere</i> sp. 2
<i>Aonides oxycephala</i> (Sars)	<i>Costa edwardsi</i> (Roemer)
<i>Aricidea</i> spp.	<i>Costa batei</i> (Brady)
<i>Brada villosa</i> (Rathke)	<i>Cythere antiquata</i> Baird
<i>Capitella capitata</i> (Fabricius)	<i>Cytheretta adriatica</i> Ruggeri
Capitellidae gen. spp.	<i>Cytheridea neapolitana</i> Kolmann
<i>Cirratulus filiformis</i> (Kieferstein)	<i>Hiltermannicythere turbida</i> (G.W.Müller)
<i>Cossura soyeri</i> Laubier	<i>Loxoconcha</i> sp. 1
<i>Dorvillea</i> sp. 1	<i>Loxoconcha</i> sp. 2
<i>Euclymene palermitana</i> (Grube)	<i>Neocytherideis</i> sp. 1
<i>Eunice vittata</i> (delle Chiaje)	<i>Neocytherideis</i> sp. 2
Hesionidae gen. spp.	<i>Pterygocythereis jonesi</i> (Baird)
<i>Hyalinoecia brementi</i> Fauvel	<i>Semicytherura</i> sp. 1
<i>Lumbrineris gracilis</i> (Ehlers)	<i>Semicytherura</i> sp. 2
	CIRRIPEDIA
	<i>Chthamalus</i> sp. 1
	DECAPODA
	<i>Callinassa stebbingi</i> Borra

<i>Carcinus</i> sp. 1	TANAIDACEA
<i>Crangon</i> sp. 1	<i>Apeudes latreillei</i> (Milne Edw.)
<i>Ethusa mascarone</i> Herbst	<i>Leptochelia savignyi</i> (Kröyer)
<i>Galathea</i> sp. 1	<i>Tanais cavolinii</i> Milne Edw.
<i>Hippolyte</i> sp. 1	LEPTOSTRACA
<i>Macropodia longirostris</i> (Fabricius)	<i>Nebalia bipes</i> Fabr.
<i>Palaemon</i> sp. 1	ACARINA
<i>Processa canaliculata</i> (Leach)	<i>Agauopsis brevipalpus</i> Trousseart
<i>Sicyonia</i> sp. 1	<i>Agauopsis</i> sp. 1
AMPHIPODA	<i>Copidognathus</i> sp. 1
<i>Ampelisca typica</i> (Bate)	<i>Copidognathus</i> sp. 2
<i>Ampelisca spinnipes</i> Boeck	INSECTA
<i>Ampelisca</i> sp. 1	Chironomidae gen. spp.
<i>Ampelisca</i> sp. 2	SIPUNCULIDA
<i>Caprella</i> sp. 1	<i>Phascolosoma</i> sp. 1
<i>Dexamine</i> sp. 1	GASTROPODA
<i>Gammarus locusta</i> (L.)	<i>Bittium reticulatum</i> Da Costa
<i>Gammarus</i> sp. 1	<i>Cerithium vulgatum</i> Bruguiere
<i>Gammarus</i> sp. 2	<i>Conus</i> sp. 1
<i>Lepidepcreum</i> sp. 1	<i>Gibbula</i> spp.
<i>Lysianassa</i> sp. 1	<i>Haminea hydatis</i> (L.)
<i>Leucothoe</i> sp. 1	<i>Monodonta</i> spp.
<i>Phthisica marina</i> Slabber	<i>Nassa</i> spp.
<i>Pseudoprotella</i> sp. 1	<i>Opisthobranchia</i> spp.
ISOPODA	<i>Polynices</i> sp. 1
<i>Anilocra physodes</i> (L.)	<i>Rissoa</i> spp.
<i>Arcturus</i> sp. 1	BIVALVIA
<i>Bopyrus squillarum</i> Latr.	<i>Aloidis gibba</i> (Olivi)
<i>Cirolana borealis</i> Lill.	<i>Cardioidea</i> spp.
<i>Cyathura carinata</i> (Kr.)	<i>Chlamys</i> sp. 1
<i>Cymodoce truncata</i> (Mont.)	<i>Gastrana fragilis</i> (L.)
<i>Dynamene</i> sp. 1	<i>Loripes lacteus</i> (L.)
<i>Gnathia</i> sp. 1	<i>Macoma</i> sp. 1
<i>Idotea baltica</i> (Pall.)	<i>Nucula sulcata</i> (Bronn)
<i>Ligia italica</i> Fabr.	<i>Tellina pulchella</i> Lamarck
<i>Limnoria</i> sp. 1	<i>Venerupis</i> sp. 1
<i>Nerocilla</i> sp. 1	BRYOZOA
<i>Synisoma</i> sp. 1	Aetidae gen. spp.
MYSIDACEA	Bicellardiidae gen. spp.
<i>Diamysis</i> sp. 1	<i>Monobryozoon</i> gen. sp. 1
<i>Mysis</i> sp. 1	
<i>Siriella clausi</i> G. Sars	
<i>Siriella</i> sp. 1	
CUMACEA	
<i>Cumella</i> sp. 1	
<i>Diastylis</i> sp. 1	
<i>Iphinoe</i> sp. 1	
<i>Leucon mediterraneus</i> Sars	

## CHAETOGNATHA

*Spadella cephaloptera* (Busch)

## HOLOTHURIOIDEA

*Holothuria* sp. 1  
*Labidoplax* sp. 1  
*Trachythryone* sp. 1

## ASTEROIDEA

*Asterina gibbosa* (Pennant)  
*Astropecten* sp. 1

## OPHIUROIDEA

*Amphipholis squamata* (Delle Chiaje)  
*Amphiura* spp.  
*Ophiothrix* spp.

## ECHINOIDEA

Echinopluteus - larvae

## ASCIDIACEA

Perophora - larvae  
Clavelinidae - larvae

## MEIOBENTOSKA FAVNA (BREZ HARPAKTIKOIDOV) JUŽNEGA DELA TRŽAŠKEGA ZALIVA: SEZNAM TAKSONOV

Borut VRIŠER

Nacionalni inštitut za biologijo, Morska biološka postaja, SI-6330 Piran, Fornače 41  
E-mail: vriser@mbss.org

## POVZETEK

Prispevek je doslej prvi poskus celovitejšega sistematskega pregleda bentoške meiofavne (izvzeti so že predstavljeni Harpacticoida), pripravljenega na osnovi obsežnega gradiva, zbranega med številnimi raziskavami v zadnjih tridesetih let na območju južnega dela Tržaškega zaliva, ki danes pripada teritorialnim vodam republike Slovenije. Poudarek dela je na taksonomskem seznamu, ki obsega 30 večjih skupin s 180 popolnoma ali le delno determiniranimi vrstami.

**Gljučne besede:** meiofavna, seznam vrst, Tržaški zaliv, Slovenija

## REFERENCES

Bartsch, I. & T. M. Iliffe (1985): The halacarid fauna (Halacaridae, Acari) of Bermuda's caves. *Stylogologia*, 1(3), 301-321.  
Bonaduce, G., G. Ciampo & M. Masoli (1975): Distribution of Ostracoda in the Adriatic sea. *Repr. Pubbl. Staz. Zool. Napoli*, 40, 1-304.

Bouillon, J. & P. A. Grohmann (1990): *Pinushydra chiquitita* gen. et sp. nov. (Cnidaria, Hydrozoa, Athecata), a solitary marine mesopsammic polyp. *Cah. Biol. Mar.*, 31, 291-305.  
Chevreux, E. & L. Fage (1925): *Faune de France*. 9. Amphipodes. Paul Lechevalier, Paris. 486 pp.  
De Min, R. & E. Vio (1997): Molluschi conchiferi del litorale sloveno. *Annales Ser. hist. nat.*, 7(1), 241-258.

Gruner, H. E. (1965): Krebstiere oder Crustacea. V. Isopoda. In: Dahl, F. (ed.): *Die Tierwelt Deutschlands*, 51. G. Fischer Verl., Jena. 371 pp.  
Grünspan, T. (1908): Beiträge zur Systematik der Gastrotrichen. *Zool. Jahrb. Syst.*, 26(2), 214-254.  
Higgins, R. P. (1977): Two new species of *Echinoderes* (Kinorhyncha) from the South Carolina. *Trans. Am. Microsc. Soc.*, 96(3), 341-354.  
Hulings, N. C. (1971): Proceedings of the first international conference on meiofauna. *Smithsonian Contr. Zool.*, 76, Washington, 126 pp.  
Hummon, W. D., M. A. Todaro, M. Balsamo & P. Tongiorgi (1990): Effects of Pollution on marine Gastrotricha in the Northwestern Adriatic Sea. *Mar. Poll. Bull.*, 21(5), 241-243.  
Evans, W. A., M. A. Todaro & W. Hummon (1993): Eutrophication and Gastrotrich diversity in the Northern Adriatic Sea. *Mar. Poll. Bull.*, 26(5), 268-272.  
Karaman, G. S. (1972): On some new or very interesting Amphipoda of the Adriatic Sea. *Mem. Mus. Civ. Stor. Nat. Verona*, 20, 99-147.  
Karaman, G. S. (1973): Contribution to the knowledge of the Amphipoda, the Phoxocephalidae family of the Adriatic Sea. *Glas. Republ. Zav. Zašt. Prir. - Prir. Muz. Titograd*, 5, 47-101.  
Klie, W. (1938): Krebstiere oder Crustacea. III. Ostracoda, Muschelkrebse. In: Dahl, F. (ed.): *Die Tierwelt Deutschlands*, 34. G. Fischer Verl., Jena, 230 pp.  
Marcotte, B. M. & B. C. Coull (1974): Pollution, diversity and meiobenthic communities in the North Adriatic (Bay of Piran, Yugoslavia). *Vie Milieu Ser. B Oceanogr.*, 24(2), 282-300.  
Meischner, D. & J. Rumohr (1974): A light-weight, high momentum gravity corer for subaqueous sediments. *Senckenb. Marit.*, 6, 105-116.  
Nordsieck, F. (1968): Die Europäischen Meeres Gehäuseschnecken (Prosobranchia). G. Fischer Verl., Stuttgart, 273 pp.  
Nordsieck, F. (1969): Die Europäischen Meeresmuscheln (Bivalvia). G. Fischer Verl., Stuttgart, 256 pp.  
Nordsieck, F. (1972): Die Europäischen Meeresschnecken (Opisthobranchia mit Pyramidellidae, Rissoaceae). G. Fischer Verl., Stuttgart, 327 pp.  
Ogorelec, B., M. Mišič & J. Faganeli (1991): Marine geology of the Gulf of Trieste (Northern Adriatic): Sedimentological aspects. *Mar. Geol.*, 99, 79-92.  
Platt, H. M. & R. M. Warwick (1983): Free-living marine Nematodes. I. British enoplids. Cambridge Univ. Press, Cambridge, London, New York, New Rochelle, Melbourne, Sydney, 307 pp.  
Platt, H. M. & R. M. Warwick (1988): Free-living marine Nematodes. II. British chromadorids. E.J. Brill / Dr. W. Backhuys, Leiden, New York, København, Köln. 502 pp.  
Riedl, R. (1956): Zur Kenntnis der Turbellarien Adriatischer Schlammböden sowie ihrer geographischen und faunistischen Beziehungen. *Thalassia Jugosl.*, 1, 69-125.

Riedl, R. (1983): *Fauna und Flora des Mittelmeeres*. Verl. Paul Parey, Hamburg, Berlin, 836 pp.  
Rieger, R. M. (1971): Die Turbellarienfamilie Dolichomacrostomidae RIEGER. II. Dolichomacrostominae I. *Zool. Jb. Syst.*, 98, 569-703.  
Salvini-Plawen, L. von (1966): Zur Kenntnis der Cnidaria des nordadriatischen Mesopsammon. Veröff. Inst. Meeresforsch. Bremerhav., 2, 165-186.  
Salvini-Plawen, L. von (1968): Neue Formen im marinen Mesopsammon: Kamptozoa und Aculifera (nebst der für die Adria neuen Sandfauna). *Ann. Nathist. Mus. Wien*, 72, 231-272.  
Sars, G. O. (1896): An account of the Crustacea of Norway. II. Isopoda, Part I, II. Apseudidae, Tanaidae. *Publ. Bergen Museum, Bergen*, 255 pp.  
Schrom, H. (1966a): Zur Kenntnis des Mesopsammones der Nordadria. II. Die Sande in der Umgebung von Rovigno und ihre Faunenmerkmale. *Thalassia Jugosl.*, 4, 65-79.  
Schrom, H. (1966b): Gastrotrichen aus Feinsanden der Umgebung von Venedig. *Boll. Mus. Civ. Stor. Nat. Venezia*, 17, 31-44.  
Schrom, H. (1966c): Verteilung einiger Gastrotrichen im oberen Eulitoral eines nordadriatischen Sandstrandes. *Veröff. Inst. Meeresforsch. Bremerhav.*, 2, 95-104.  
Sterrer, W. (1965): *Gnathostomula axi* Kirsteuer und *Austrognathia* (ein weiteres gnathostomuliden - genus) aus der Nordadria. *Z. Morph. Ökol. Tiere*, 55, 783-795.  
Sterrer, W. (1967): Beiträge zur Kenntnis der Gnathostomulida. I. Anatomie und Morphologie des Genus *Pterognathia* Sterrer. *Arkiv för Zoologi*, 22(1), 1-125.  
Vrišer, B. (1979): Modifikacije meiofavne v umetno poluiranem lagunarnem ekosistemu. *Biol. vestn.*, 27(1), 75-86.  
Vrišer, B. (1982): Strukture in bioprodukcijske značilnosti meiofavne v čistem in umetno onesnaženem okolju Strunjske lagune. *Acta Adriat.*, 23(1/2), 339-353.  
Vrišer, B. (1983-84): Meiofaunal community structure and species diversity in the Bays of Koper, Strunjan and Piran (Gulf of Trieste, North Adriatic). *Nova Thalassia*, 6, 5-17.  
Vrišer, B. (1986): Vpliv organskega onesnaženja na meiofavno priobalnih glinastih muljev Koprškega zaliva. *Biol. vestn.*, 34(2), 93-104.  
Vrišer, B. (1989): Meiofavna južnega dela Tržaškega zaliva. I. Taksonomska struktura in abundanca. *Biol. vestn.*, 37(4), 65-76.  
Vrišer, B. (1991): Meiofauna of the southern part of the Gulf of Trieste (Northern Adriatic) II. Problems of the mesoscale spatial distribution. *Biol. vestn.*, 39(1), 165-176.  
Vrišer, B. (1992): Meiofavna južnega dela Tržaškega zaliva. III. Favna in združbe harpaktikoidov (Copepoda: Harpacticoida). *Biol. vestn.*, 40(2), 89-106.  
Vrišer, B. (1996): Sezonska dinamika in variabilnost harpaktikoidov (Copepoda : Harpacticoida) v Tržaškem



zalivu: triletna raziskava. Annales Ser. hist. nat., 6(1), 53-60.

**Vrišer, B. (1997):** Seasonal and three-year variability of meiofauna in the Gulf of Trieste (Northern Adriatic). Period. biol., 99(2), 209-212.

**Vrišer, B. (1998):** Meiofaunal recolonization of defaunated sediments: a field experiment; preliminary results. Period. biol., 100(1), 63-69.

**Vrišer, B. (1999):** Meiofauna Strunjanskega zaliva 18 let pozneje: ponovljena raziskava. Annales Ser. hist. nat., 9(2), 209-212.

**Vrišer, B. (2000a):** Meiobenthic Harpacticoida (Copepoda) from the southern part of the Gulf of Trieste (northern Adriatic). I. List of taxa. Annales Ser. hist. nat., 10(1), 23-38.

**Vrišer, B. (2000b):** Meiobenthic Harpacticoida (Copepoda) from the southern part of the Gulf of Trieste (northern Adriatic). II. Ecology and spatial distribution. Annales Ser. hist. nat., 10(1), 39-53.

**Vrišer, B. (2001):** Meiofauna Izolske luke pred graditvijo marine in po njej: ponovljena raziskava – preliminarni rezultati. Annales Ser. hist. nat., 11(1), 75-78.

**Vrišer, B. (2002):** The meiofauna of two protected shallow biotopes on the Slovene coast: the Škocjan inlet and the Strunjan lagoon. Annales Ser. hist. nat., 12(2), 203-210.

**Vrišer, B. & A. Vukovič (1999):** Seasonal and long-term variability of meiofauna in the environment, frequently affected by hypoxia in central part of the Gulf of Trieste. Annales Ser. hist. nat., 9(2), 203-208.

**Vrišer, B. & A. Vukovič (2000):** Meiofaunal recolonization of defaunated sediments: II. Harpacticoida (Copepoda); preliminary results. Period. biol., 102(2), 201-206.

**Wieser, W. (1960):** Benthic studies in Buzzards Bay. II. The meiofauna. Limnol. Oceanogr., 5, 121-137.

original scientific article  
received: 2003-01-05

UDK 595.3:575.17(262-191.2)

## ENZYMATIC VARIABILITY OF MEDITERRANEAN SLIPPER LOBSTERS, *SCYLLARIDES LATUS*, FROM SICILIAN WATERS

Marco L. BIANCHINI

CNR and Soc. Porto Romano, I-Rome, Piazza P. Paoli 3

E-mail: imarbot@mclink.it

Ehud SPANIER

Leon Recanati Institute for Maritime Studies, University of Haifa, IL-31905 Haifa, Mount Carmel

Sergio RAGONESE

Ist. ricerche Risorse Marine e l'Ambiente, IRMA/CNR, I-91026 Mazara del Vallo (TP), Via Luigi Vaccara 61

### ABSTRACT

A genetic comparison of slipper lobsters, *Scyllarides latus*, from different areas in Sicily was carried out, electrophoretically checking 22 enzymatic activity zones. The analysis has shown a low degree of variability among the specimens; therefore, non-local breeders might be used for restocking without harming the biodiversity.

**Key words:** Crustacea, Decapoda, Scyllaridae, *Scyllarides*, genetics, electrophoresis

### VARIABILITÀ ENZIMATICA NELLA MAGNOSA MEDITERRANEA, *SCYLLARIDES LATUS*, DI ACQUE SICILIANE

#### SINTESI

L'articolo presenta il confronto genetico tra magnose (*Scyllarides latus*) provenienti da diverse aree siciliane, confronto effettuato con il controllo elettroforetico di 22 zone di attività enzimatica. L'analisi ha evidenziato un basso grado di variabilità tra gli individui, pertanto gli autori ipotizzano che esemplari allevati in altre località potrebbero venir usati nel ripopolamento, evitando effetti negativi sulla biodiversità.

**Parole chiave:** Crustacea, Decapoda, Scyllaridae, *Scyllarides*, genetica, elettroforesi

## INTRODUCTION

On the Sicilian coasts, restocking of the now rare Mediterranean slipper lobster, *Scyllarides latus*, could achieve stable results, since the decline of the resource seems due to a shortage in recruitment, not to environmental degradation (Bianchini et al., 1998). Of course, a sound enhancement program should operate without disrupting the existing equilibrium.

To preserve the biological diversity, and to reduce the risks related to the introduction in the genetic pool of characteristics different from the local ones, it is necessary to make sure that brooders and seeding animals belong to the autochthonous population, or that their origin is genetically similar. With this in mind, morphological (Bianchini et al., 1996) and karyological (Deiana et al., 1997) studies may be used for screening, together with genetic analyses, based on PCR methods or on electrophoretic techniques.

This last approach is based on the notion that proteins under the effect of an electric field migrate along the medium in accordance to their net charge and their molecular weight; utilizing this phenomenon, the electrophoresis displays molecular differences due to aminoacidic substitutions or deletions. In fact, these differences arise from nucleotide mutations at DNA level of the structural gene, which produce isozymes (Hunter & Markert, 1957) migrating at different velocities. The isozymes, i.e. the multiple forms that an enzyme could as-

sume, may depend on the presence of more than one locus codifying the enzyme (allozymes, following Prakash et al., 1969), or on the effect of post-translational modifications on the formed polypeptic chains (Richardson et al., 1986); a locus is considered polymorphic when the frequency of the most common allele is lower than 95%.

The last step in the analysis of enzymatic polymorphisms is the interpretation of the observed electrophoretic pattern, which requires special care in case of species not extensively studied (Richardson et al., 1986).

## MATERIALS AND METHODS

Thirty-three Mediterranean slipper lobsters, *Scyllarides latus*, coming from different Sicilian areas (Fig. 1) were examined; their morphometric data are given in Table 1.

The electrophoretic runs were commissioned to an external University laboratory, using funds provided by a national program on slipper lobster restocking (III triennial plan of the former Ministry of Merchant Marine).

Pereiopod muscles were used; samples were transported in liquid N<sub>2</sub> to the laboratory, where they were manually homogenized in water, centrifuged at 3000 rpm for 30 min, and stored at -70 °C.

The methodology used to study the *Scyllarides latus* population was the electrophoretic analysis of the enzymatic polymorphisms.

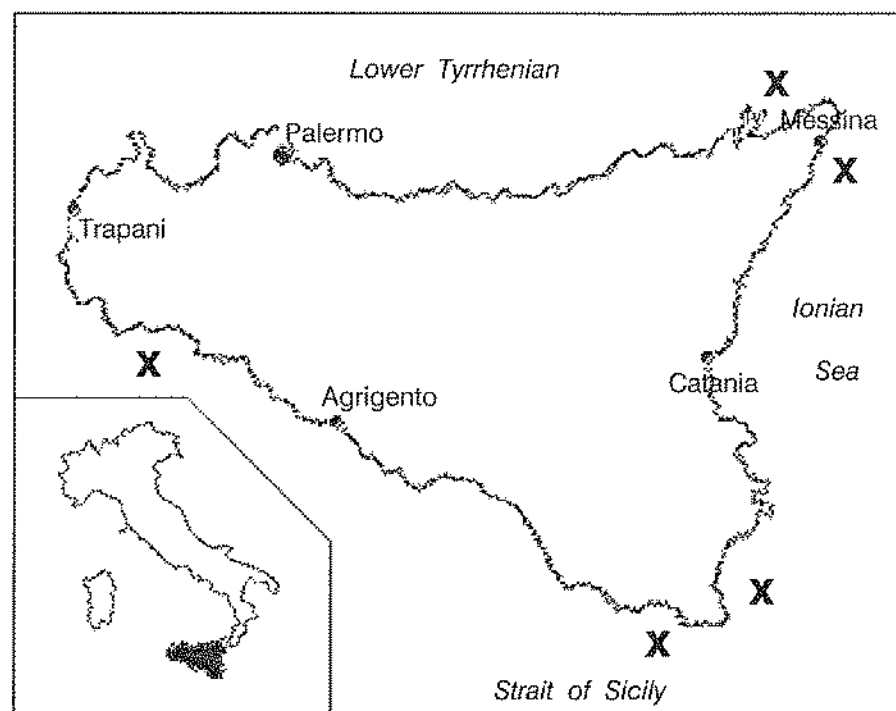

Fig. 1: Areas of collection (crosses) of the Sicilian "population" of slipper lobster (*Scyllarides latus*).  
Fig. 1: Območja zbiranja (križci) sicilijanske "populacije" velikega nagajivca (*Scyllarides latus*).

Cellogel (cellulose acetate) was used as support; the electrophoretic runs were performed in Chemetron tanks filled with 250 ml of bridge buffer, holding 3 cellogel stripes (5.7x14 cm), pre-soaked for 15 min in a gel buffer equal to that of the run ("continuous buffer"). Each cellogel strip carried 5 samples; to allow comparison, the last sample of each strip was repeated on the next one.

At the end of the run, every strip was coloured with techniques specific for each enzyme, using buffered solutions with substrates, coenzymes and/or coupled enzymes and colours that bond with the final products. A thermostat was used for the enzymatic reaction; once the colour appeared, the reaction was stopped immersing the cellogel stripes in acetic acid (10%), and the stripes were sealed and kept at 4 °C.

Twenty enzymatic sets, accounting for 22 independently variable activity zones, i.e. accounted as the product of 22 loci, were examined. Table 2 reports the tested enzymes, their abbreviations, and the number of interpreted loci; the allele designation follows the numeric system based on the relative gel mobility of isozymes.

Table 3 reports, for each tested enzyme, the run conditions (buffers, times, applied tension in Volt, electrical input in mA, depending on the buffer ionic strength) and the colouring techniques, as well as the respective bibliographic references.

Tab. 1: Morphometric characteristics of the slipper lobsters (*Scyllarides latus*) analysed electrophoretically by sex (F = female, M = male).

Tab. 1: Morfometrične značilnosti velikih nagajivcev (*Scyllarides latus*), analizirane elektroforetično po spolu (F = moški, M = ženske).

	F	M
number	13	20
weight (g)		
mean	440.6	361.7
SD	191.0	76.7
min	258.0	237.0
max	940.0	523.0
carapace length (mm)		
mean	100.4	94.8
SD	13.2	7.0
min	88.6	81.7
max	132.2	106.7

## RESULTS

The Sicilian slipper lobsters show a very modest electrophoretic variability in the 22 examined loci (Tab. 4): 20 loci are completely, or almost completely, fixed in the same allele, and the polymorphism is low in the other 2 loci (IDH and MDH-2) too.

Table 5 reports the estimates of the populational genetic variability, expressed as mean number of alleles per locus ( $N_a$ ), percent of polymorphic loci (p), observed ( $H_o$ ) and expected ( $H_e$ ) heterozygosity (Nei, 1978). The studied population presents low values of polymorphism, with  $H_o=0.020$ ,  $H_e=0.019$ , mean number of alleles per locus equal to 1.2 and percent of polymorphic loci equal to 9.1.

Moreover, the observed genotypic frequencies were compared with the expected frequencies, to display possible divergences from the Hardy-Weinberg equilibrium, per population and per locus (Tab. 6). Using the  $\chi^2$  analysis, the studied Sicilian population of *S. latus* results in substantial equilibrium in all the examined loci.

Tab. 2: Enzymatic systems analysed electrophoretically in the slipper lobster (*Scyllarides latus*).

Tab. 2: Elektroforetično analizirani encimatski sistemi velikega nagajivca (*Scyllarides latus*).

enzyme (Enzyme Commission number)	abbreviation	No. of loci
Alcohol dehydrogenase (1.1.1.1)	ADH	1
Adenilate chinase (2.7.4.3)	ADK	1
Aldolase (4.1.2.13)	ALDO	1
Creatine chinase (2.7.3.2)	CK	1
Esterase (3.1.1.1)	EST	1
Fructose-1,6-diphosphatase (3.1.3.11)	FDP	1
Fumarase (4.2.1.2)	FUM	2
Glyceraldehyde-3-phosphate dehydrogenase (1.2.1.12)	GAPD	1
Glucose-phosphate isomerase (5.3.1.9)	GPI	1
Esochinase (2.7.1.1)	HK	1
Isocitrate dehydrogenase (1.1.1.42)	IDH	1
Lactate dehydrogenase (1.1.1.27)	LDH	1
Malate dehydrogenase (1.1.1.37)	MDH	2
Malic enzyme (1.1.1.40)	ME	1
Mannose-phosphate isomerase (5.3.1.8)	MPI	1
Amino-peptidase (3.4.11)	PEP	1
6-Phosphogluconate dehydrogenase (1.1.1.44)	6PGD	1
Phosphoglucomutase (2.7.5.1)	PGM	1
Trioso-phosphate isomerase (5.3.1.1)	TPI	1
Xantine dehydrogenase (1.2.1.37)	XDH	1

Total number of analyzed enzymes = 20

Total number of interpreted loci = 22



Tab. 3: Electrophoretic methods used for separation of the slipper lobster (*Scyllarides latus*) samples.  
Tab. 3: Elektroforetične metode, uporabljene za ločevanje primerkov velikega nagajivca (*Scyllarides latus*).

enzyme	buffer (conc.)	Volt/hour/mA	coloring technique (reference)
ADH	C (1x)	160/2:00/10	Richardson et al., 1986
ADK	B (2 x)	160/2:30/18	Richardson et al., 1986
ALDO	TEC 0.075 (1x)	160/2:00/14	Harris & Hopkinson, 1976
CK	C (2x)	160/2:00/18	Richardson et al., 1986
EST	G (1x)	160/1:00/18	Richardson et al., 1986
FDP	B (1x)	160/2:00/10	Richardson et al., 1986
FUM	A (2x)	160/1:30/8	Richardson et al., 1986
GAPD	C (1x)	160/2:00/10	Richardson et al., 1986
GPI	C (1x)	160/2:00/10	Richardson et al., 1986
HK	C (1x)	160/1:15/10	Richardson et al., 1986
IDH	A (1x)	160/1:45/10	Ayala et al., 1972
LDH	B (1x)	160/1:45/10	Selander et al., 1971
MDH	C (1x)	160/1:30/10	Richardson et al., 1986
ME	B (1x)	160/1:30/10	Richardson et al., 1986
MPI	B (1x)	160/1:00/10	Richardson et al., 1986
PEP	A (2x)	160/1:45/8	Richardson et al., 1986
6PGD	B (1x)	160/1:30/10	Richardson et al., 1986
PGM	C (1x)	160/1:45/8	Richardson et al., 1986
TPI	B (1x)	160/2:00/10	Richardson et al., 1986
XDH	F (1x)	160/1:45/18	Richardson et al., 1986

Bibliographic references for the buffers:  
A, B, C, F, G: Richardson et al., 1986  
TEC 0.075: Meera Khan, 1971

DISCUSSION

The electrophoretic analysis of the enzymatic polymorphisms has shown low levels of variability in the Sicilian population of *Scyllarides latus*. This result should not be interpreted as a bottleneck effect of the numerical scarcity of the Sicilian population, but may be structural to the taxon (Hardwick & Cline, 1984, 1985, 1986). In fact, preliminary unpublished results on two other populations, from Israel and from the Açores, seem to confirm a minimal heterozygosity. Moreover, this lack of genetic diversity is in substantial agreement with the pattern observed in other species of large-size decapod crustaceans (Hedgecock, 1987).

On the other hand, the apparent resemblance of the slipper lobster samples could be linked to peculiar variability patterns of the gene-enzyme systems hitherto tested; other kind of loci might display higher levels of variation.

The genetic analyses have shown a high similitude among the studied animals, coming from distant geographical locations: this fact suggests that non-local specimens could be used, as breeders or seeding stuff, in restocking and stock enhancement programs in impoverished areas, without exorbitant risks of genetic

contamination and biodiversity reduction.

Nevertheless, the seemingly genetic homogeneity of the Mediterranean slipper lobsters needs further testing, perhaps with more sophisticated techniques (e.g. the analysis of microsatellite loci), before the actual introduction of allochthonous material.

CONCLUSIONS

On the Sicilian coasts, restocking of the now rare Mediterranean slipper lobster, *Scyllarides latus*, could achieve stable results, since the decline of the resource seems due to a shortage in recruitment, not to environmental degradation. To preserve the biodiversity, and to reduce the risks related to the introduction in the genetic pool of characteristics different from the local ones, it is necessary to make sure that brooders and seeding animals belong to the autochthonous population, or that their origin is genetically similar.

With this in mind, a genetic comparison of slipper lobsters, *Scyllarides latus*, from different areas in Sicily was carried out, electrophoretically checking 22 enzymatic activity zones (ADH, ADK, ALDO, CK, EST, FDP, FUM-1, FUM-2, GAPD, GPI, HK, IDH, LDH, MDH-1, MDH-2, ME, MPI, PEP-2, 6PGD, PGM, TPI, XDH).

Tab. 4: Frequencies of alleles for 22 loci in the Sicilian population of slipper lobster (*Scyllarides latus*). Legend: N = number of specimens; A = most common/only allele; B = second allele.  
Tab. 4: Frekvence alel za 22 lokacij sicilijanske populacije velikega nagajivca (*Scyllarides latus*). Legenda: N = št. primerkov; A = najpogostejši/edini alel; B = drugi alel.

locus	
ADH	
N	29
A	1.000
ADK	
N	24
A	1.000
ALDO	
N	29
A	1.000
CK	
N	24
A	1.000
EST	
N	29
A	0.983
B	0.017
FDP	
N	27
A	1.000
FUM-1	
N	29
A	1.000
FUM-2	
N	29
A	0.983
B	0.017
GAPD	
N	29
A	1.000
GPI	
N	29
A	1.000
HK	
N	29
A	1.000

locus	
IDH	
N	29
A	0.948
B	0.052
LDH	
N	29
A	1.000
MDH-1	
N	29
A	0.983
B	0.017
MDH-2	
N	29
A	0.879
B	0.121
ME	
N	29
A	1.000
MPI	
N	29
A	1.000
PEP-2	
N	29
A	1.000
6PGD	
N	29
A	1.000
PGM	
N	29
A	1.000
TPI	
N	29
A	1.000
XDH	
N	29
A	1.000

Tab. 5: Genetic variability estimates (± standard error) for 22 loci in the Sicilian population of slipper lobster (*Scyllarides latus*).

Tab. 5: Ocene genske variabilnosti (± standardna napaka) za 22 lokacij sicilijanske populacije velikega nagajivca (*Scyllarides latus*).

mean No. ind./populat. (± SD)	mean No. alleles/locus (N <sub>a</sub> )	% polymorphic loci (p)	mean heterozygosity (± SD)	
			observed (H <sub>o</sub> )	expected (H <sub>e</sub> )
28.5 (0.3)	1.2 (0.1)	9.1	0.020 (0.012)	0.019 (0.011)

Tab. 6:  $\chi^2$  test for the rejection of the Hardy-Weinberg equilibrium in the Sicilian population of slipper lobster (*Scyllarides latus*).

Tab. 6: Test  $\chi^2$  za zavrnitev Hardy-Weinbergovega ravnovesja v sicilijanski populaciji velikega nagajivca (*Scyllarides latus*).

locus/class	observed	expected	$\chi^2$	d.o.f.	P
EST			0.000	1	1.000
A-A	28	28.000			
A-B	1	1.000			
B-B	0	0.000			
FUM-2			0.000	1	1.000
A-A	28	28.000			
A-B	1	1.000			
B-B	0	0.000			
IDH			0.057	1	0.812
A-A	26	26.053			
A-B	3	2.895			
B-B	0	0.053			
MDH-1			0.000	1	1.000
A-A	28	28.000			
A-B	1	1.000			
B-B	0	0.000			
MDH-2			0.461	1	0.497
A-A	22	22.368			
A-B	7	6.263			
B-B	0	0.368			

The Sicilian slipper lobsters show a very modest electrophoretic variability in the examined loci. 20 loci are completely, or almost completely, fixed in the same allele, and the polymorphism is low in the other 2 loci (IDH and MDH-2) too. The observed heterozygosity ( $H_o$ ) equals 0.020, and the expected heterozygosity ( $H_e$ ) equals 0.019, the mean number of alleles per locus ( $N_a$ ) is 1.2 and the percent of polymorphic loci is 9.1. Moreover, using the  $\chi^2$  analysis, the studied Sicilian population of *S. latus* results in substantial equilibrium in all the examined loci.

In fact, this lack of genetic diversity is in substantial agreement with the pattern observed in other species of large-size decapod crustaceans. The genetic analyses have shown a high similitude among the studied animals, coming from distant geographical locations: this result suggests that non-local specimens could be used, as breeders or seeding stuff, in restocking and stock enhancement programs in impoverished areas, without exorbitant risks of genetic contamination and biodiversity reduction.

## ENCIMATSKA VARIABILNOST VELIKEGA NAGAJIVCA, *SCYLLARIDES LATUS*, V SICILIJANSKIH VODAH

Marco L. BIANCHINI

CNR and Soc. Porto Romano, I-Rome, Piazza P. Paoli 3

E-mail: imarbot@mlink.it

Ehud SPANIER

Leon Recanati Institute for Maritime Studies, University of Haifa, IL-31905 Haifa, Mount Carmel

Sergio RAGONESE

Ist. ricerche Risorse Marine e l'Ambiente, IRMA/CNR, I-91026 Mazara del Vallo (TP), Via Luigi Vaccara 61

### POVZETEK

V sicilijanskih obalnih vodah bi z vlaganjem zdaj redkega velikega nagajivca, *Scyllarides latus*, dosegli brzkone dobre rezultate, saj vse kaže, da upadanja njegove populacije ne gre pripisati degradaciji tega morskega okolja. Toda da bi ohranili biodiverzitetu v teh vodah in hkrati zmanjšali tveganja, povezana z vlaganjem osebkov v genetski "pool" z značilnostmi, ki se razlikujejo od lokalnih, bi bilo treba zagotoviti, da osebkovi za razplod teh rakov pripadajo avtohtoni populaciji, ali pa da je njihov izvor genetsko podoben lokalnemu.

V ta namen smo opravili genetske primerjave med velikimi nagajivci, *Scyllarides latus*, iz različnih območij sicilijanskih obalnih voda z elektroforetičnim pregledovanjem 22 encimatskih con aktivnosti (ADH, ADK, ALDO, CK, EST, FDP, FUM-1, FUM-2, GAPD, GPI, HK, IDH, LDH, MDH-1, MDH-2, ME, MPI, PEP-2, 6PGD, PGM, TPI, XDH).

Na raziskanih lokalitetah je bila ugotovljena zelo skromna elektroforetična variabilnost velikih nagajivcev. 20 lokalitet je docela, ali skoraj docela, ustaljenih v istem alelu, polimorfizem pa je nizek tudi v dveh preostalih lokacijah (IDH in MDH-2). Opazovana heterozigotnost ( $H_o$ ) je bila 0,020, pričakovana heterozigotnost ( $H_e$ ) 0,019, srednje število alel na lokaliteto ( $N_a$ ) 1,2 in odstotek polimorfične lokalitete 9,1. Poleg tega smo z analizo  $\chi^2$  ugotovili, da je preučevana sicilijanska populacija velikega nagajivca v precejšnjem ravnovesju na vseh pregledanih lokacijah.

Pravzaprav se to pomanjkanje genetske pestrosti v precejšnji meri ujema z vzorcem, opaženim pri drugih vrstah velikih dekapodnih rakov. Genetske analize so pokazale veliko podobnost med preučevanimi živalmi z oddaljenih geografskih lokacij, kar daje misliti, da bi za razplod in povečanje populacije v teh osiromašenih vodah lahko uporabili osebkove iz drugih voda, in to brez večjih tveganj za genetsko "kontaminacijo" in zmanjšano biodiverzitetu v sicilijanskih obalnih vodah.

**Ključne besede:** Crustacea, Decapoda, Scyllaridae, *Scyllarides*, genetika, elektroforeza

### REFERENCES

- Ayala, F. J., J. R. Powell, M. L. Tracey, C. A. Mourao & S. Perez-Salas (1972): Enzyme variability in the *Drosophila willistoni* group. IV. Genic variation in natural populations of *Drosophila willistoni*. *Genetics*, 70, 113-139.
- Bianchini, M. L., L. Chessa, S. Greco, S. Ragonese & G. Scarpelli (1996): Morphometric aspects of slipper lobster, *Scyllarides latus*. Proc. VI. Coll. Crustacea Decapoda Medit. 12-15 September 1996, Firenze, Italy.
- Bianchini, M. L., S. Greco & S. Ragonese (1998): Il progetto "Valutazione della fattibilità e potenzialità del ri-

popolamento attivo per la magnosa, *Scyllarides latus* (Crustacei Decapodi)": sintesi e risultati. *Biol. Mar. Medit.*, 5(3), 1277-1283.

Deiana, A. M., M. L. Bianchini, E. Coluccia, A. Milia, R. Cannas, D. Serran & S. Salvadori (1997): Dati preliminari sulla carilogia della magnosa (*Scyllarides latus*, Crustacea, Decapoda). *Biol. Mar. Medit.*, 4(1), 640-642.

Hardwick, C. W. Jr. & G. B. Cline (1984): Genetic characterization of a population of *Scyllarides nodifer* using isoelectric focusing (IEF) on some gene products. *J. Ala. Acad. Sci.*, 55, 140-162.

Hardwick, C. W. Jr. & G. B. Cline (1985): Differences in isoelectric focusing and electrophoretic mobility of iso-



zymes and proteins in tissue extracts of the slipper lobster *Scyllarides nodifer* (Stimpson). *Isozyme Bull.*, 18, 53-55.

**Hardwick, C. W. Jr. & G. B. Cline (1986):** Isozymic analysis of the slipper lobster *Scyllarides nodifer* (Stimpson) from the northern Gulf of Mexico. *Isozyme Bull.*, 19, 34-35.

**Harris, H. & D. A. Hopkinson (1976):** Handbook of enzyme electrophoresis in human genetics. North Holland Publ. Co., Amsterdam, 374 pp.

**Hedgecock, D. (1987):** Population genetic bases for improving cultured crustaceans. Proc. World Symp. Selection, Hybridization, Genetic Engineering in Aquaculture, Vol. 1, Berlin.

**Hunter, R. L. & C. L. Markert (1957):** Histochemical demonstration of enzymes separated by zone electrophoresis in starch gel. *Science*, 125, 1294-1295.

**Meera Khan, P. (1971):** Enzyme electrophoresis on cellulose acetate gel: zymogram patterns in man-mouse

and man-Chinese hamster somatic cell hybrids. *Arch. Biochem. Biophys.*, 145, 470-483.

**Nei, M. (1978):** Estimation of average heterozygosity and genetic distance from a small number of individuals. *Genetics*, 89, 583-590.

**Prakash, S., R. C. Lewontin & J. L. Hubby (1969):** A molecular approach to the study of genic heterozygosity in natural populations. IV. Patterns of genic variation in central, marginal and isolated populations of *Drosophila pseudo-obscura*. *Genetics*, 61, 841-858.

**Richardson, B. J., P. R. Baverstock & M. Adams (1986):** Allozyme electrophoresis: a handbook for animal systematics and population studies. Academic Press, Sydney, Orlando.

**Selander, R. K., M. H. Smith, S. Y. Yang, W. E. Johnson & J. B. Gentry (1971):** Biochemical polymorphism and systematics in the genus *Peromyscus*. I. Variations in the old-field mouse (*Peromyscus polionotus*). In: *Studies in genetics*. Vol. VI. Univ. Texas Publ. 7103, 49-90.

short scientific article  
received: 2003-06-30

UDK 599.51(262:3)

## FIRST RECORD OF THE HUMPBACK WHALE, *MEGAPTERA NOVAEANGLIAE* (BOROWSKI, 1781), FROM THE ADRIATIC SEA

Marco AFFRONTI, Leandro Augusto STANZANI & Giacomo STANZANI  
Fondazione Cetacea Onlus, I-47838 Riccione (RN), Via Milano 63  
E-mail: [ambientemare@fondazionecetacea.org](mailto:ambientemare@fondazionecetacea.org)

### ABSTRACT

Only five records of humpback whale *Megaptera novaeangliae* (Borowski, 1781) have been reported from the entire Mediterranean Sea, but none from the Adriatic. Here we report on a 90-minute sighting of a 9-10 m long specimen in the central Adriatic in August 2002.

**Key words:** *Megaptera novaeangliae*, humpback whale, first record, Adriatic Sea

## PRIMA SEGNALAZIONE DI MEGAPTERA *MEGAPTERA NOVAEANGLIAE* (BOROWSKI, 1781) IN MARE ADRIATICO

### SINTESI

Per il mare Mediterraneo sono note solo cinque segnalazioni di megattera *Megaptera novaeangliae* (Borowski, 1781), fino ad oggi nessuna delle quali in Adriatico. L'articolo riporta l'avvistamento durato novanta minuti di un esemplare di megattera di 9-10 metri, in Adriatico centrale.

**Parole chiave:** *Megaptera novaeangliae*, megattera, primo avvistamento, mare Adriatico

## INTRODUCTION

Humpback whales *Megaptera novaeangliae* (Borowski, 1781) are distributed in all oceans, ranging from tropical wintering grounds along the islands and continental coasts to the edges of polar ice zones in summer. In the eastern North Atlantic they overwinter around the Cape Verde Islands and off northwest Africa. These stocks spend summer from New England to southeastern Baffin Island, along the western coast of Greenland, north to Disko Bay, around Iceland and around Norway.

The summer migration of the Cape Verde population northward is still poorly documented (Leatherwood & Reeves, 1983).

Humpback whales are seen around Cape Verde Islands from December until June. If the migration from Cape Verde northward really exists, it should therefore start from May (Jann & Wenzel, 2001; Jann et al., in press). The relationships between the animals in Cape Verde and those wintering in the West Indies remain unknown. But the analysis of humpback songs from the Cape Verde Islands and the West Indies suggests a possible exchange of animals between these feeding grounds (Winn & Winn, 1978).

No documented population of humpback whales exists in the Mediterranean, where the specimens observed were certainly vagrants from the eastern North Atlantic population.

Only five records have been reported for the entire Mediterranean Sea: a young specimen captured near Toulon (France) in 1885; two specimens sighted and photographed in 1986 north of Minorca (Balearic Islands, Spain); a juvenile in the Gulf of Gabes (Tunisia) in 1992, and a young specimen incidentally captured near Cavalaire (France) in 1993 (Notarbartolo di Sciarra, 2002). In April 2001, a humpback whale, measuring about 10-11 m in length and seemingly in good health, was seen breaching in the Argolic Gulf near Tolos (Greece), about 55 miles southwest of Athens. Video footage was presented during the 15<sup>th</sup> European Cetacean Society Meeting held in Rome in May 2001. Additional records are currently in press by Frantzis and colleagues (Frantzis et al., in press).

In this paper we report the first record of *Megaptera novaeangliae* in the Adriatic Sea and the Italian waters.

## MATERIALS AND METHODS

The Adriatic basin is part of the Mediterranean Sea, linked to its central part through the Strait of Otranto. The bottom is mainly sandy or muddy. It is a warm sea with a mean temperature almost always above 11-12 °C. The shallow northern basin is cooler in winter, reaching 6-8 °C, and warmer in summer, when the surface temperature can reach 26-28 °C. The salinity shows great oscillations and the coastal water can be greenish due to

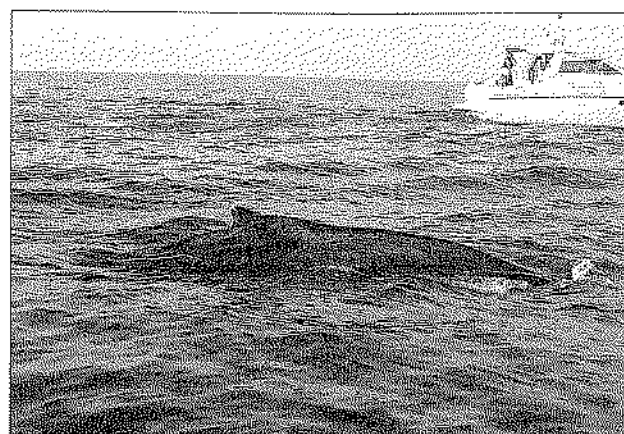

**Fig. 1: The humpback whale's back appeared skinny, with vertebra protruding. (Photo: G. Stanzani)**  
**Sl. 1: Osebkov hrbet se je zdel mršav z močno poudarjenimi hrbtničnimi vretenci. (Foto: G. Stanzani)**

the high concentration of phytoplankton. After heavy rains it can take on a yellow color (Buljan & Zore-Armanda, 1976).

As part of the national network of Centro Studi Cetacei, Fondazione Cetacea is working on marine mammals in the northern Adriatic Sea. Within this framework, the Fondazione Cetacea began, in 1993, the "Onde dal Mare" (Waves from the sea) project, whose purpose is to increase the awareness about cetacean species living in Italian waters. This is done through education and active participation of all persons either working at sea (fishermen or sailors) or vacationing there. The project consists of a network of "calling centers" usually located in marine protected areas, aquaria or other facilities able to contact a large number of people.

## RESULTS AND DISCUSSION

On 4 August, 2002, at 13:00 h, the Pesaro Coast Guard reported a sighting of a "big cetacean" off the Fano coast (43°50' N, 13°02' E). Three hours later, the specimen was sighted again by a sports boat, only 150 meters off the coast of Senigallia (43°45' N, 13°15' E). The Fondazione Cetacea group reached the animal, with the help of Protezione Civile Numana and Monte Conero diving center of Numana, at about 18:00 h. In the meantime it had moved about 2 miles off. The very long, almost completely white flippers and the typical knobs on the head and on the leading edge of the flippers allowed us to identify it as a humpback whale. It was about 9-10 m in total length.

We followed the specimen for about 1.5 hrs, in good sea, wind and visibility conditions. During the entire sighting, the humpback whale was moving steadily southward without notable deviation. Many photographs and a video were taken (Figs. 1 and 2).

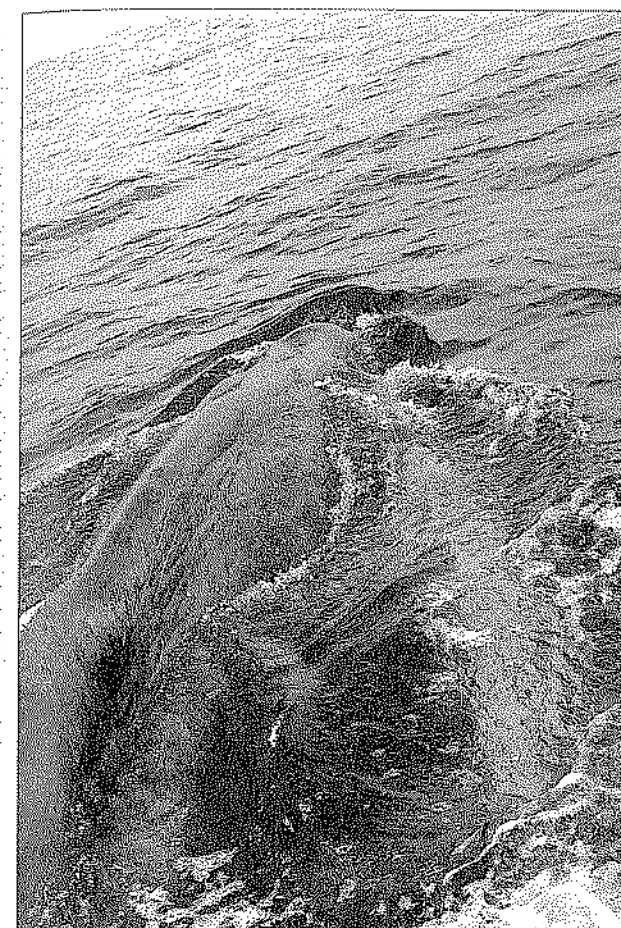

**Fig. 2: The very long and white flippers are amongst the most recognizable features of the humpback whale. (Photo: G. Stanzani)**

**Fig. 2: Zelo dolge, bele prsne plavuti so med najbolj opaznimi značilnostmi kita grbavca. (Foto: G. Stanzani)**

The specimen seemed to be in distress and very weakened as confirmed by the photographs and video observation. The back, normally much smoother in an animal in good health, displayed strange indentations and "bumps". When the visual contact with the animal was lost, it was swimming south. We received no further news in the following days, either from the Coast Guard or from fishermen, so we can only assume that it left the Adriatic basin.

## ACKNOWLEDGMENTS

Many thanks are due to Luca Amico and the Protezione Civile of Numana staff and to Marco Giuliano and the Centro Sub Monte Conero, Numana for their irreplaceable support. We also thank Giampaolo Rallo, Maurizio Spoto and Paolo Zucca for promptly alerting us.

PRVI ZAPIS O KITU GRBAVCU *MEGAPTERA NOVAEANGLIAE* (BOROWSKI, 1781) IN THE ADRIATIC SEA

Marco AFFRONTÉ, Leandro Augusto STANZANI & Giacomo STANZANI  
 Fondazione Cetacea Onlus, I-47838 Riccione (RN), Via Milano 63  
 E-mail: ambientemare@fondazionecetacea.org

## POVZETEK

Kit grbavec *Megaptera novaeangliae* (Borowski, 1781) je bil v Sredozemskem morju doslej zabeležen le petkrat, a še nikoli v Jadranskem morju. Najstarejši zapis je znan iz leta 1885, ko so v bližini Toulona v Franciji ujeli mladega grbavca. Nadalje sledijo s fotografijami dokumentirano opazovanje dveh grbavcev v vodah okoli Menorce (Baleari) iz leta 1986, zapis o mladem osebkju v zalivu Gabes (Tunizija) iz leta 1992 ter zapis o nesrečno ujetem mladiču pri Cavalaire v Franciji leta 1993. Nekaj svežih podatkov o pojavljanju grbavca v grških vodah pa še čaka objavo. V pričujočem zapisu avtorji obravnavajo 90 minut dolgo opazovanje kita grbavca 4. avgusta 2002 v vodah blizu Sennigalie (43°45' N, 13°15' E).

**Ključne besede:** *Megaptera novaeangliae*, kit grbavec, prvi zapis, Jadransko morje



## REFERENCES

- Buljan, M. & M. Zore-Armanda (1976):** Oceanographical properties of the Adriatic Sea. *Oceanogr. Mar. Biol. Annu. Rev.*, 14, 11-98.
- Frantzis, A., P. Alexiadou, G. Paximadis, E. Politi, A. Gannier & M. Corsini-Foka (in press):** Current knowledge on the cetacean fauna of the Greek Seas. *J. Cetacean Res. Manage.*
- Jann, B. & F. W. Wenzel (2001):** Humpback whales in the Cape Verde Islands. Paper SC/NAH19, IWC Scientific Committee, July 2001, London.
- Jann, B., J. Allen, M. Carrillo, S. Hanquet, S. K. Katona, A. R. Martin, R. R. Reeves, R. Seton, P. T. Stevick & F. W. Wenzel (in press):** Migration of a humpback whale between Cape Verde Islands and Iceland. *J. Cetacean Res. Manage.*
- Leatherwood, S. & R. R. Reeves (1983):** The Sierra Club Handbook of Whales and Dolphins. Sierra Club Books, San Francisco, CA, USA.
- Notarbartolo di Sciara, G. (2002):** Cetaceans species occurring in the Mediterranean and Black Seas. In: Notarbartolo di Sciara, G. (ed.): Cetaceans species occurring in the Mediterranean and Black Seas: state of knowledge and conservation strategies. A report to the ACCOBAMS Secretariat, Monaco, February 2002, Section 3, 17 pp.
- Winn, H. E. & L. K. Winn (1978):** The song of the humpback whale, *Megaptera novaeangliae*, in the West Indies. *Mar. Biol.*, 47, 97-114.

KLIMATSKE SPREMEMBE

VARIAZIONI CLIMATICHE

CLIMATE CHANGES

original scientific article  
received: 2003-04-18

UDK 581.5:551.542(497.4)

## SPRING PHENOLOGICAL TRENDS IN SLOVENIA

Zalika ČREPINŠEK & Lučka KAJFEŽ-BOGATAJ

Biotechnical Faculty, University of Ljubljana, SI-1000 Ljubljana, Jamnikarjeva 101  
E-mail: zalika.crepinsek@bf.uni-lj.si

### ABSTRACT

The long-term phytphenological and meteorological data set for the 1955-2000 period was analysed to assess the impact of increased winter and spring temperatures on the plant development in Slovenia. The 46-year series of the leaf unfolding and flowering were studied for 11 plants (herbaceous plants, shrubs and trees) at eight selected observation points. The mean linear trends in phenophases appearance were negative, ranging from -1.4 days per decade for leaf unfolding, -2.2 days per decade for late-spring flowering, and -3.1 days per decade for early-spring flowering. This resulted in earlier leaf unfolding of 6 days and earlier flowering of 10-14 days for the discussed period. A 10-day shift to earlier spring in Slovenia corresponded well with changes in early-spring temperatures from February to April.

**Key words:** phenology, growing season, trends, air temperature changes, Slovenia

## TENDENZE FENOLOGICHE PRIMAVERILI IN SLOVENIA

### SINTESI

L'articolo riporta l'analisi di una serie pluriennale di dati fitofenologici e meteorologici per il periodo 1955-2000, effettuata allo scopo di valutare l'impatto dell'innalzamento delle temperature invernali e primaverili sullo sviluppo delle piante in Slovenia. La serie studiata comprende dati inerenti la schiusa delle gemme e la fioritura per 11 piante (erbacee, arbusti ed alberi) in otto postazioni d'osservazione per un periodo di 46 anni. Le tendenze lineari medie delle fenofasi sono risultate negative, variando tra -1.4 giorni per decennio per la schiusa delle gemme, -2.2 giorni per decennio per la fioritura tardo-primaverile, e -3.1 giorni per decennio per la fioritura all'inizio della primavera. Considerando l'intero periodo di osservazione, le autrici concludono che la schiusa delle gemme si è verificata nell'ultimo decennio con un anticipo medio di 6 giorni, mentre hanno calcolato un anticipo di 10-14 giorni per la fioritura rispetto alla prima decade di osservazione. Le variazioni osservate in Slovenia, ossia un anticipo di 10 giorni nella comparsa della primavera, corrispondono alle variazioni della temperatura dell'aria all'inizio del periodo primaverile, da febbraio ad aprile.

**Parole chiave:** fenologia, stagione di crescita, tendenze, variazioni della temperatura dell'aria, Slovenia



## INTRODUCTION

Phytophenology deals with the recurring growth and development phenomena of plants in their annual rhythm (Lieth, 1974). The occurrence times of characteristic vegetation stages (phenophases) are in close relation to the climate of the observation site and current weather. Inter-annual changes in spring plant phenology may be the most sensitive and observable indicators of the plant response to climate change (Beaubien & Freeland, 2000). There are significant differences between the way different plants species respond to climate change. Even small differences in phenology between species can lead to rather large changes in growth when they grow in mixed stands, and consequently also to a significant change of selection pressure (Kramer *et al.*, 2000).

Earlier spring development is occurring in different parts of Europe. The earliest flowering species in the growing season show more variability in bloom time over the years than later-flowering species (Fitter *et al.*, 1995). Ahas (1999) reported that springtime has advanced 8 days on average over the last 80-year period; the last 40-year period has warmed even faster. Phenological data of the International Phenological gardens for the period 1969-1998 showed that the average beginning of growing season across Europe advanced by 8 days (Chmielewski & Rötzer, 2002). The investigation showed (Chmielewski & Rötzer, 2001) that a warming in the early spring (February-April) by 1 °C causes an advance in the beginning of growing season of 7 days. Study by Defila & Clot (2001) showed a clear trend towards earlier appearance dates in spring in Switzerland. For Hungary, Walkovszky (1998) investigated the changes in phenology of the locust tree: a rise in temperature by 1 °C led to a week earlier flowering. Trends in timing of phenological events have been described for England by Fitter *et al.* (1995) and Sparks *et al.* (2000). Earlier spring plant development has been reported also for North America (Beaubien & Freeland, 2000): a movement forwards by 8 days in the timing of spring development was noticed in the Edmonton area (Alberta/Canada) over the last six decades. The observed trends in the onset of spring corresponded well with changes in air temperatures and circulation (North Atlantic Oscillation) in Europe (Chmielewski & Rötzer, 2001; Črepinšek *et al.*, 2002) respectively with Southern Oscillation over western Canada (Beaubien & Freeland, 2000).

Besides being influenced by temperature and the length of day, phenological dates are mainly induced by weather during the actual vegetation period, the past vegetation period and the dormancy period (Defila & Clot, 2001). Man-induced changes are thought to be among the causes of global warming, and higher temperatures in late winter and early spring induce growing season to become earlier (Bergant *et al.*, 2002). This study analyses long-term phenological time series to assess the impact of air temperature changes on selected plants in Slovenia.

## MATERIAL AND METHODS

For the long-term phenological analyses only the best quality phenological data, that over at least 30 years, were selected. The study is based on eleven common plants at eight different observation points (Tab. 1). These phenological data-series were extracted from the historical phenological data set of the Environmental Agency of Slovenia. Spring phenophases (leaf unfolding, flowering) were selected for study as the effect of climate change is more pronounced in early spring in Slovenia and owing to the availability of quality data set. First, logical and critical control of the data was performed including plotting of all phenological data. No data were added or corrected because filling in the gaps could change the trends of complete records. For this study, the phenological dates of eleven species were combined in an annual leaf unfolding index, early-spring flowering index and late-spring flowering index to determine the changes at the beginning of the growing season in Slovenia for the 1955-2000 period (Tab. 1). Combining species phenophases to derive an index value has the advantage of summarizing plant responses to weather conditions over extended period or region (Castonguay & Dube, 1985; Beaubien & Freeland, 2000; Chmielewski & Rötzer, 2001). Such phenological information, combined from several stations, obtain a common but more reliable data (Schaber, 2002). For the study of phenological and mean monthly air temperature time series, the linear trend analysis was used. For statistical analysis, the STATGRAPHICS Plus 4.0 and EXCEL 2002 standard modules were applied. Correlations were calculated between phenological data and mean monthly air temperatures for 46 years (1955-2000).

Tab. 1: Phenological data: phenophases, indicator plants, phenological indexes and locations.  
Tab. 1: Fenološki podatki: fenofaze, indikatorske rastline, fenološki indeksi, lokacije.

<b>PHENOPHASES</b>	
- First leaf unfolding date	
- Flowering date	
<b>INDICATOR PLANTS</b>	
- beech	<i>Fagus sylvatica</i> L.
- black locust	<i>Robinia pseudacacia</i> L.
- common elder	<i>Sambucus nigra</i> L.
- common lilac	<i>Syringa vulgaris</i> L.
- common silver birch	<i>Betula pendula</i> Roth.
- dandelion	<i>Taraxacum officinale</i> Weber/Wiggers
- goat willow	<i>Salix caprea</i> L.
- hazel	<i>Corylus avellana</i> L.
- horse-chestnut	<i>Aesculus hippocastanum</i> L.
- large-leaved lime	<i>Tilia platyphyllos</i> Scop.
- snowdrop	<i>Galanthus nivalis</i> L.
<b>PHENOLOGICAL INDEXES</b>	
Phenological data set was used to calculate four phenological indexes:	
<b>Leaf unfolding index - LI</b>	
Leaf unfolding index is determined as the annual mean of the leaf unfolding dates for beech, common silver birch, large-leaved lime and horse-chestnut.	
<b>Early-spring flowering index - F<sub>1I</sub></b>	
Early-spring-flowering index is determined as the annual mean of the flowering dates for common silver birch, dandelion, goat willow, hazel and snowdrop.	
<b>Late-spring flowering index - F<sub>2I</sub></b>	
Late-spring flowering index is determined as the annual mean of the flowering dates for black locust, common elder, common lilac and large-leaved lime.	
<b>Growing season index - GSI</b>	
Growing season index is the mean value of the three phenological indexes (LI, F <sub>1I</sub> , F <sub>2I</sub> ) for eleven species at eight locations: $GSI = (LI + F_{1I} + F_{2I})/3$	
<b>LOCATIONS</b>	
- Celje	46°15'N, 15°15'E, 242 m a.s.l.
- Ilirska Bistrica	45°34'N, 14°15'E, 414 m a.s.l.
- Lesce	46°22'N, 14°11'E, 515 m a.s.l.
- Ljubljana	46°04'N, 14°31'E, 299 m a.s.l.
- Maribor	46°32'N, 15°39'E, 275 m a.s.l.
- Murska Sobota	46°39'N, 15°12'E, 190 m a.s.l.
- Novo mesto	45°48'N, 15°11'E, 220 m a.s.l.
- Rateče	46°30'N, 13°43'E, 864 m a.s.l.

## RESULTS

## Growing season index and its variability

The beginning of growing season is an important feature in agriculture and forestry. Its variability is

mainly driven by environmental factors, particularly by temperature. As a long-term average (1955-2000), the beginning of growing season (defined as growing season index - GSI) in Slovenia starts on 24 April. Standard deviation of growing season index is 6.7 days and variation interval 30 days. Between 1988 and 2000, 11 out of

13 years showed an earlier onset of spring comparing long-term average (Fig. 1). Five earliest springs were noticed in 1994, 1990, 1989, 2000 and 1998. The beginning of growing season was extremely early in 1994 (10 April), and extremely late in 1956 (8 May).

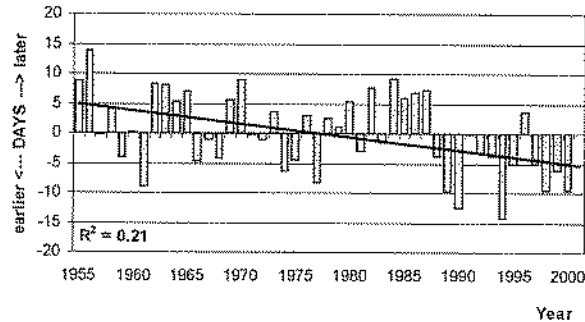

Fig. 1: Long-term trend in growing season index. The Julian days are shown as deviations from the mean growing season index for all data.

Sl. 1: Dolgoletni trend indeksa rastne sezone. Julijanski dnevi so prikazani kot odkloni od povprečnega indeksa rastne sezone za vse podatke.

Tab. 2: Long-term trends of spring phenological phases in Slovenia for the 1955-2000 period. Significant trends are marked as follows: \*\*\*  $p < 0.01$ , \*\*  $p < 0.05$ , \*  $p < 0.10$ .

Tab. 2: Dolgoletni trendi pomladanskih fenofaz v Sloveniji za obdobje 1955-2000. Značilni trendi so označeni: \*\*\*  $p < 0.01$ , \*\*  $p < 0.05$ , \*  $p < 0.10$ .

Phenological phase	Change (days per decade)	Regression	R <sup>2</sup>
Flowering of black locust	-2.6	-0.27	0.21***
Flowering of common elder	-2.6	-0.25	0.21***
Flowering of common lilac	-2.2	-0.21	0.16**
Flowering of common silver birch	-1.3	-0.14	0.06*
Flowering of dandelion	-1.7	-0.18	0.07*
Flowering of goat willow	-4.6	-0.45	0.24***
Flowering of hazel	-4.3	-0.44	0.13**
Flowering of large-leaved lime	-1.3	-0.14	0.08*
Flowering of snowdrop	-3.7	-0.37	0.17**
Leaf unfolding of beech	-1.1	-0.11	0.10**
Leaf unfolding of common silver birch	-2.0	-0.19	0.13**
Leaf unfolding of horse-chestnut	-1.7	-0.18	0.14**
Leaf unfolding of large-leaved lime	-0.6	-0.07	0.03

Trends

The trends of all phenological phases (each phenological phase is average for eight locations) are given in Table 2. All but one of the trends of the spring records were significantly negative (38% at the 0.01 level, 31% at the 0.05 level, 23% at the 0.10 level; 8% were not significant). Negative trends indicate an earlier onset of leaf unfolding and flowering during the past decades. The mean linear trends (days/decade) ranged from -1.4 for leaf unfolding, -2.2 for late-spring flowering, and -3.1 for early-spring flowering. This means a movement forward by 6 days in the timing of leafing and of 10-14 days in the timing of flowering. The growing season index showed a significant negative trend of -2.2 days per decade, corresponding to 10 days earlier beginning of growing season over the last five decades.

There are differences among the spring trends of different phenophases observed, the higher trends being found for early-spring flowering of *Coryllus*, *Salix* and *Galanthus*, indicating that changes of events occurring in the early spring are more distinct and related to considerable change in late-winter and early-spring temperatures (Fig. 3). Changes are more distinct for phenophases of flowering, indicating that these phenophases are more sensitive to air temperatures.

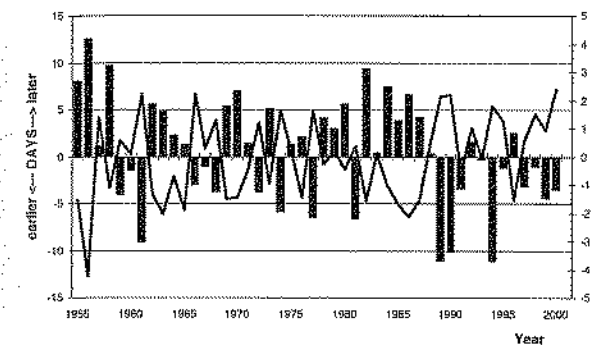

Fig. 2: Leaf unfolding index and air temperatures with deviations from the long-term means (1955-2000). Vertical bars represent the annual leaf unfolding indexes (the mean of first leaf unfolding dates for: *Fagus sylvatica*, *Betula pendula*, *Aesculus hippocastanum* and *Tilia platyphyllos*) expressed as deviations in days from the mean value. The line represents the annual deviations of temperature (°C) from the spring mean temperature (February-April).

Sl. 2: Indeks olistanja in temperature zraka z odkloni od dolgoletnega povprečja (1955-2000). Navpični stolpci ponazarjajo letne indekse olistanja (povprečje datumov olistanja za *Fagus sylvatica*, *Betula pendula*, *Aesculus hippocastanum* in *Tilia platyphyllos*), izražene kot odklon (število dni) od povprečja. Krivulja ponazarja letni odklon temperature zraka (°C) od povprečja temperature pomladnih mesecev (februar-april).

Relations to air temperatures

The annual timing of spring phenophases is largely a response to temperature and reflects thermal conditions of the current year and location. From February to April, significant negative correlation coefficients between GSI and temperature were found, meaning that higher temperatures in early spring promote earlier flowering and leaf unfolding (Fig. 4). Annual monthly temperatures for eight locations for February, March and April were averaged for each year. These temperatures and GSI correlated at high significant correlation coefficient ( $R = -0.90$ ). A comparison with the simpler relationship with the one-month temperatures confirmed that relationships were tighter when the temperatures of many months were dealt with together. The later beginning of growing season was associated well with lower than average temperatures (Figs. 1 & 2). According to the regression equation, a warming of 1 °C promotes beginning of growing season by 4.1 days in Slovenia (Fig. 4).

A trend analysis of air temperature was carried out in order to investigate the cause of spring phenological trends. Mean temperatures for the months of February, March and April were averaged for each year for eight

selected locations. We found positive trend in air temperature (+ 1.6 °C) for months from February to April in the last 46 years, which explicated the observed trend at the beginning of growing season (Fig. 5).

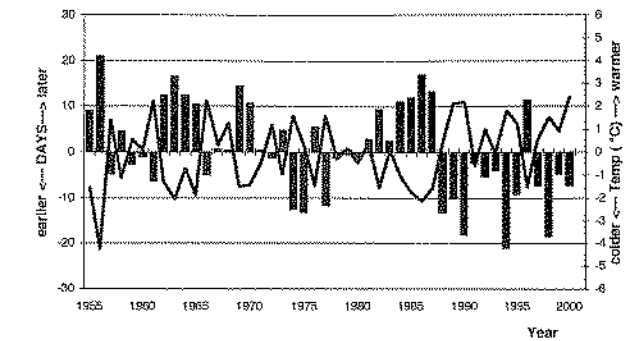

Fig. 3: Early-spring flowering index and air temperatures with deviations from the long-term means (1955-2000). Vertical bars represent the annual early-spring indexes (the mean of flowering dates for: *Betula pendula*, *Taraxacum officinale*, *Salix caprea*, *Corylus avellana* and *Galanthus nivalis*) expressed as deviations in days from the mean value. The line represents the annual deviations of temperature (°C) from the spring mean temperature (February-April).

Sl. 3: Indeks cvetenja v zgodnji pomladi in temperature zraka z odkloni od dolgoletnega povprečja (1955-2000). Navpični stolpci ponazarjajo letne indekse cvetenja (povprečje datumov cvetenja za: *Betula pendula*, *Taraxacum officinale*, *Salix caprea*, *Corylus avellana* in *Galanthus nivalis*), izražene kot odklon (število dni) od povprečja. Krivulja ponazarja letni odklon temperature zraka (°C) od povprečja temperature pomladnih mesecev (februar-april).

DISCUSSION

Our investigation has shown that there has been a trend to earlier leaf unfolding and flowering over the last 46 years in Slovenia. The obtained results concerning the regional trend in the beginning of growing season in Slovenia agreed with those for Europe-wide trends of Chmielewski & Rötzer (2002) and Menzel (2000). Spring phenological trends correspond well with changes in air temperature of early spring (February-April). The results of our analysis confirm the findings of others authors concerning the influence of air temperature on the timing of spring events (Chmielewski & Rötzer, 2001). The result that an increase in mean spring temperature of 1 °C is associated with an advanced beginning of growing season by 4 days coincide with the findings of Fitter *et al.* (1995) and Sparks *et al.* (2000).



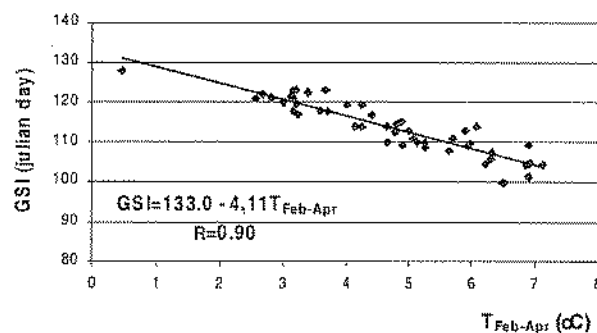

Fig. 4: Relationship between mean spring temperature  $T_{Feb-Apr}$  (February to April) and growing season index (GSI). A warming of  $1\text{ }^{\circ}\text{C}$  in  $T_{Feb-Apr}$  means approximately 4 days earlier beginning of growing season in Slovenia.

Sl. 4: Povezava med temperaturo pomladnih mesecev  $T_{Feb-Apr}$  (februar-april) in indeksom rastne sezone (GSI). Otoplitev za  $1\text{ }^{\circ}\text{C}$  glede na  $T_{Feb-Apr}$  pomeni približno 4 dni zgodnejši začetek rastne sezone v Sloveniji.

There is no doubt that the global warming led to an earlier beginning of growing season. What are implications of this trend to earlier development for plant species? Plants have different sensitivities to climatic oscillations; this could lead to changes in the population dynamics. Differences in phenological response may affect competition between plant species (Kramer *et al.*, 2000) and promote those with better adaptive response. Changes in species distribution and abundance are the expected results of climate change, which may have positive or negative effects. New crop varieties can become more productive for certain regions and on the other hand new pests, diseases or weediness risk can turn up. We would expect that flowering will remain in approximate synchrony with the pollinating species, but implications of trends in phenological responses need to be examined for all levels of system plant-environment system (Beaubien, 1996). An increasing frequency of warmer winters and springs may result in intensified damage because of late spring frosts in agronomy or forestry resulted in the year's seed production lost or decreasing forest community composition following early promoted growth.

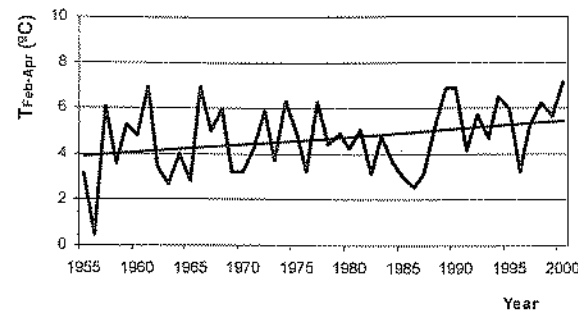

Fig. 5: Long-term trend in mean air temperature from February to April ( $T_{Feb-Apr}$ ) in Slovenia for the 1955-2000 period.

Sl. 5: Dolgoletni trend povprečne temperature zraka od februarja do aprila ( $T_{Feb-Apr}$ ) v Sloveniji za obdobje 1955-2000.

If the predicted winter and spring warming over the next decades is carried into effect, then we must expect a continued trend to earlier development, but a linear extrapolation of the statistical trends, found in our or in other investigations, is of course not adequate. The lower limit for a spring phenophases date is probably best determined by examining species phenology at the southern limit of their distribution (Sparks *et al.*, 2000). The early spring phenophases provides the best timing predictor for subsequent plant events and thus phenological data and trends over time could assist us in adapting to climate change and variability.

#### CONCLUSIONS

The most important results of this study can be summed up as follows:

1. Spring phenological data for the 1955-2000 period were combined in an annual leaf unfolding index, early spring flowering index and late spring flowering index to determine the changes at the beginning of growing season in Slovenia.
2. In the last five decades, the average beginning of growing season in Slovenia has advanced by 10 days, whereby the extreme early dates were observed in the last decade.
3. There were significant differences among the trends of different phenophases in spring: the mean linear trends ranged from  $-1.4$  day per decade for leaf unfolding;  $-2.2$  days per decade for late spring flowering, and  $-3.1$  days per decade for early spring flowering.
4. The leaf unfolding was 6 days earlier and flowering 10-14 days earlier over the 46 years studied.

5. The observed trends at the beginning of growing season correspond well with the changes in air temperature in the early spring from February to April.

6. A warming in the early spring by  $1\text{ }^{\circ}\text{C}$  leads to an advanced spring by approximately 4 days in Slovenia.

#### ACKNOWLEDGEMENTS

Phenological and meteorological data sets were kindly supplied by the Environmental Agency of the Slovene Ministry of the Environment, Spatial Planning and Energy.

#### TRENDI POMLADANSKIH FENOFAZ V SLOVENIJI

Zalika ČREPINŠEK & Lučka KAJFEŽ-BOGATAJ

Biotehniška fakulteta, Univerza v Ljubljani, SI-1000 Ljubljana, Jamnikarjeva 101

E-mail: zalika.crepinsek@bf.uni-lj.si

#### POVZETEK

Avtorici pričujočega prispevka sta na osnovi dolgoletnih fenoloških in meteoroloških podatkov za obdobje 1955-2000 analizirali vpliv naraščajočih temperatur zimskih in pomladnih mesecev na fenološki razvoj rastlin v Sloveniji. Na osmih izbranih lokacijah sta analizirali 46-letni niz podatkov za fenofazo olistanja pri bukvi, navadni brezi, navadni lipi in divjem kostanju ter za fenofazo cvetenja pri navadni brezi, regratu, ivi, leski, zvončku, robiniji, črnem bezgu, španskem bezgu in navadni lipi. Da bi ugotovili spremembe ob začetku rastne sezone, sta fenološke podatke združili v letnem indeksu olistanja, indeksu cvetenja v zgodnji pomladi in indeksu cvetenja v pozni pomladi. Trendi spomladanskih fenofaz različnih rastlin so se med sabo statistično značilno razlikovali. Srednji linearni trendi (dnevi na dekada) so se gibali med  $-1,4$  za fenofazo olistanja,  $-2,2$  za fenofazo cvetenja v pozni pomladi in  $-3,1$  za fenofazo cvetenja v zgodnji pomladi. V preučevanem obdobju je olistanje nastopilo v zadnji dekadi v povprečju 6 dni zgodneje, cvetenje pa 10-14 dni zgodneje glede na začetno dekada. Ugotovljene spremembe (10-dnevni zgodnejši nastop pomladi) v povprečnem začetku rastne sezone v Sloveniji so se ujemale s spremembami temperature zraka zgodaj spomladi (med februarjem in aprilom). Raziskave so pokazale, da je otoplitev za  $1\text{ }^{\circ}\text{C}$  zgodaj spomladi pospešila začetek rastne sezone za 4 dni.

**Ključne besede:** fenologija, rastna sezona, trendi, spremembe temperature zraka, Slovenija

#### REFERENCES

- Ahas, R. (1999): Long-term phyto-, ornitho- and ichthyophenological research for the 21<sup>st</sup> century. *Int. J. Biometeorol.*, 42(3), 119-123.
- Beaubien, E.G. (1996): Relationships between plant phenology in continental western Canada and Pacific Ocean temperatures. In: Hočevar, A., Z. Črepinšek & L. Kajfež-Bogataj (eds.): Proceedings of the 14<sup>th</sup> International Congress of Biometeorology, Ljubljana, 1-8 Sept 1996. Mednarodno biometeorološko društvo in Slovensko meteorološko društvo, Ljubljana, p. 150-160.
- Beaubien, E. G. & H. J. Freeland (2000): Spring phenology trends in Alberta, Canada: links to ocean temperature. *Int. J. Biometeorol.*, 44(2), 53-59.
- Bergant, K., L. Kajfež-Bogataj & Z. Črepinšek (2002): Statistical downscaling of GCM simulated average monthly air temperature to the beginning of flowering of dandelion (*Taraxacum officinale*) in Slovenia. *Int. J. Biometeorol.*, 46(1), 22-32.
- Castonguay, Y. & P. A. Dube (1985): Climatic analysis of a phenological zonation: A multivariate approach. *Agric. Forest Meteorol.*, 35, 31-45.
- Chmielewski, F. M. & T. Rötzer (2001): Response of tree phenology to climate change across Europe. *Agric. Forest Meteorol.*, 108(2), 101-112.
- Chmielewski, F. M. & T. Rötzer (2002): Annual and spatial variability of the beginning of growing season in Europe in relation to air temperature changes. *Clim. Res.*, 19, 257-264.

**Črepinšek, Z., L. Kajfež-Bogataj & K. Bergant (2002):** Correlation between spring phenophases and North Atlantic oscillation index in Slovenia. Research reports. Biotechnical Faculty, University of Ljubljana, Ljubljana, 79(1), p. 89-98.

**Defila, C. & B. Clot (2001):** Phytophenological trends in Switzerland. *Int. J. Biometeorol.*, 45(4), 203-207.

**Fitter, A. H., R.S.R. Fitter, I.T.B. Harris & M. H. Williamson (1995):** Relationships between first flowering date and temperature in the flora of a locality in central England. *Funct. Ecol.*, 9, 55-60.

**Kramer, K., I. Leinonen & L. Loustau D. (2000):** The importance of phenology for the evaluation of impact of climate change on growth of boreal, temperate and Mediterranean forest ecosystems: an overview. *Int. J. Biometeorol.*, 44(2), 67-75.

**Lieth, H. (1974):** Purposes of a Phenology Book. In: Lieth, H. (ed.): *Phenology and Seasonality Modelling*. Ecological Studies 8. Springer-Verlag, New York, 444 pp.

**Menzel, A. (2000):** Trends in phenological phases in Europe between 1951 and 1996. *Int. J. Biometeorol.*, 44, 76-81.

**Schaber, J. (2002):** Phenology in Germany in the 20<sup>th</sup> century: Methods, Analyses and Models. PIK Report No. 78. Potsdam Institute for Climate Impact Research, Potsdam, 146, 39-91.

**Sparks, T. H., E. P. Jeffree & C. E. Jeffree (2000):** An examination of the relationship between flowering times and temperature at the national scale using long-term phenological records from the UK. *Int. J. Biometeorol.*, 44(2), 82-87.

**Walkovszky, A. (1998):** Changes in phenology of the locust tree (*Robinia pseudoacacia* L.) in Hungary. *Int. J. Biometeorol.*, 41(4), 155-160.

pregledni članek  
prejeto: 2003-04-04

UDK 551.582:551.577(497.4-14)"13/18"

## SUHA IN MOKRA LETA V SUBMEDITERANSKI SLOVENIJI OD 14. DO SREDE 19. STOLETJA

Darko OGRIN

Oddelek za geografijo, Filozofska fakulteta, Univerza v Ljubljani, SI-1000 Ljubljana, Aškerčeva 2  
E-mail: Darko.Ogrin@ff.uni-lj.si

### IZVLEČEK

V prispevku je prikazan poskus rekonstrukcije suhih in mokrih let v času med 14. in sredo 19. stoletja v primorskem delu Slovenije. Podatke smo večinoma črpali iz sekundarnih in terciarnih zgodovinskih virov, predvsem kronik. Podnebje slovenskega Primorja je submediteransko, z razmeroma pogostimi sušami v poletnih mesecih, ki so na Krasu tudi posledica njegovih petrografskih značilnosti. Izdelana kronologija sušnih in nadpovprečno mokrih let ne omogoča popolne klimatske rekonstrukcije, ker je podatkov premalo. Kljub temu pa lahko izločimo tri obdobja s pogostejšimi sušami: 1540 do 1662, prva polovica 18. stoletja in prva polovica 19. stoletja.

**Ključne besede:** suša, variiranje podnebja, klimatologija, Submediteranska Slovenija, Slovenija

### ANNI DI SICCIÀ ED ANNI DI PIOGGE NELLA SLOVENIA SUBMEDITERRANEA DAL 14° ALLA METÀ DEL 19° SECOLO

#### SINTESI

Nell'articolo viene presentato il tentativo di ricostruzione dell'andamento degli anni di siccità e quelli di piogge nel periodo compreso tra il 14° e la metà del 19° secolo nel litorale sloveno. I dati provengono principalmente da fonti storiche secondarie e terziarie, soprattutto croniche. Il clima del litorale sloveno è submediterraneo, con una frequenza relativamente alta di periodi di siccità nei mesi estivi, dovuti anche a fattori parzialmente petrografici sul Carso. La cronologia ottenuta per gli anni di siccità e per quelli di piogge non ha portato ad una ricostruzione climatica completa, a causa di un'insufficienza di dati. Nonostante ciò, l'autore evidenzia tre periodi di siccità frequente: dal 1540 al 1662, la prima metà del 18° secolo e la prima metà del 19° secolo.

**Parole chiave:** siccità, variazioni climatiche, climatologia, Slovenia submediterranea, Slovenia



## UVOD

Slovenija ima povprečno okoli 1500 mm padavin letno, kar jo uvršča med najbolj namočene predele Evrope in tudi sveta. Največ jih pade na alpsko-dinarski pregradi, v 120 do 130 padavinskih dnevih tudi več kot 3000 mm. Od tod se namočenost zmanjšuje proti morju, kjer zabeležijo kakih 1000 mm padavin v okoli 100 padavinskih dneh in proti V oziroma SV, kjer jih v Prekmurju pade od 800 do 900 mm (Ogrin, 2002; Vrhovc, 2002).

Razporeditev padavin prek celotnega leta je razmeroma enakomerna, zato običajno ni daljših in izrazitih sušnih ali namočenih obdobj. Posledica dobre namočenosti in zmernih temperatur je vlažnostni suficit, saj v Sloveniji ni pokrajine, kjer bi potencialna evapotranspiracija glede na dolgoletna povprečja presežala količino padavin. Določen primanjkljaj se pojavlja samo v poletnih mesecih v Primorju in Prekmurju, kjer pa je običajno vendarle dovolj padavin za normalno rast vegetacije.

Neugodna značilnost padavin v Sloveniji je njihova velika variabilnost. V povprečju znaša okoli 30%, v posameznih letih pa je pri mesečnih vsotah dolgoletno povprečje lahko preseženo za več kot 100% ali pa padavin praktično ni, in to ne glede na letni čas. Posledica tega so lahko suše in poplave. Problem aktualnih suš, še posebej v kmetijstvu, je dobro poznan in v strokovni literaturi ustrezno predstavljen (npr. Natek, 1987; Dolinar-Lešnik, 1989; Matajč, 1991, 1995, 1996, 2002; Gams, 1999). Še bolj pereč pa bi utegnil postati problem pomanjkanja vlage v rastni sezoni z vidika napovedanih podnebnih sprememb, kar nakazuje zadnje desetletje, ko temperature naraščajo in so suše pogostejše. Po nekaterih napovedih (Kajfež-Bogataj, 1998; Anonymous, 2001) naj bi se temperature v Sloveniji do srede tega stoletja povečale za okoli 2 °C, količina padavin pa zmanjšala za 10 do 20%. To bi pomenilo razširitev zaradi suše potencialno ogroženih območij in večjo pogostost in intenzivnost suš v pokrajinah, ki so jih suše ogrožale tudi doslej, med njimi tudi dela Slovenije s submediteranskim podnebjem. Pri teh napovedih pa je pogosto zanemarjeno dejstvo, da se je podnebje spreminjalo tudi v preteklosti in da smo že imeli obdobja, ko so bile tudi suše pogostejše. Poznavanje preteklega podnebnja in njegovih posledic pa je lahko dobra osnova za oceno razmer in ogroženosti v prihodnje.

V prispevku smo se omejili na problem osvetlitve suš v predinstrumentalnem obdobju, to je pred letom 1841, ko je začela delovati meteorološka postaja v Trstu. Tržaška postaja je namreč dober reprezentant klimatskih razmer v Submediteranski Sloveniji, še posebej obalnega dela, njeni kontinuirani podatki pa dajejo dobro osnovo za študij variacij podnebnja od srede 19. stoletja do današnjih dni. Za zdaj pa imamo zelo skromno

podatkovno bazo za študij razmer v času pred začetkom delovanja te postaje.

### PODNEBNE ZNAČILNOSTI SUBMEDITERANSKE SLOVENIJE

Z imenom Submediteranska Slovenija označujemo nižji JZ del Slovenije, ki je reliefno odprt proti Tržaškemu zalivu oziroma Jadranskemu morju in ima zato milejše klimatske potoze v primerjavi s pokrajinami v notranosti Slovenije. Orograška pregrada južnih Julijskih Alp in do 1500 m visokih dinarskih planot (Banjšice, Trnovski gozd, Nanos, Hrušica, Javorniki, Vremščica in Snežnik) razmejuje pokrajine, v katerih še prevladujejo potoze mediteranskega podnebnja, od preostale Slovenije, ki ima zmerno kontinentalno oziroma gorsko podnebje (Sl. 1). Značilnosti mediteranskega podnebnja se prepletajo z vplivi celinskega in gorskega podnebnja, kar se kaže v nekoliko nižjih temperaturah ter več padavinah kot pri pravem mediteranskem podnebjem in modificiranem padavinskem režimu. V geografski in klimatološki literaturi (npr. Ogrin, 1996; Gams, 1998) zato to podnebje označujemo za omiljeno mediteransko oziroma submediteransko, predel Slovenije, ki ima to podnebje, pa Submediteranska Slovenija.

Zanj so značilne pozitivne povprečne januarske temperature, julijske temperature nad 20 °C in 2000 do 2400 ur s soncem na leto, kar je največ v Sloveniji. Zaradi zadrževalnega učinka morja so jesenske temperature višje od spomladanskih. Padavin je od 1000 mm ob obali, do 1700 mm ob vznožju reliefnih pregrad, kjer so razmeroma enakomerno razporejene prek celotnega leta. Kljub temu pa sta opazna dva viška in dva nižka padavin, ki sta posledica prepletanja mediteranskih in celinskih podnebnih značilnosti. Običajno pade največ padavin jeseni, novembra ali oktobra, sekundarni višek je junija na prehodu pomladi v poletje. Najmanj padavin je na prehodu zime v pomlad (januar, februar, marec) ter v juliju in avgustu (Ogrin, 1996). V letnem povprečju potencialna evapotranspiracija ne presega količine padavin, a se v topli polovici leta zaradi visokih temperatur pojavlja vlažnostni deficit, in to kljub temu da v povprečju pade tudi v poletnih mesecih od 80 do 100 mm padavin (Pristov, 1994). Primanjkljaj, ki je največji v obalnih predelih, kjer imajo 2 do 4 °C višje temperature in prejmejo manj padavin, traja od maja do avgusta. Vlažnostni deficit je manjši in obdobje z njim teoretično krajše v višjem in bliže reliefni pregradi ležečem širšem zaledju Tržaškega zaliva. Toda dejanski učinek suše je v kraškem zaledju kljub pogostejšim padavinam in nekoliko nižjim temperaturam zaradi tanke odeje prsti in njene slabe sposobnosti za zadrževanje vlage prav tako velik kakor v flišni pokrajini ob morju. Zato so te pokrajine zaradi suše enako ogrožene kakor priobalni predeli.

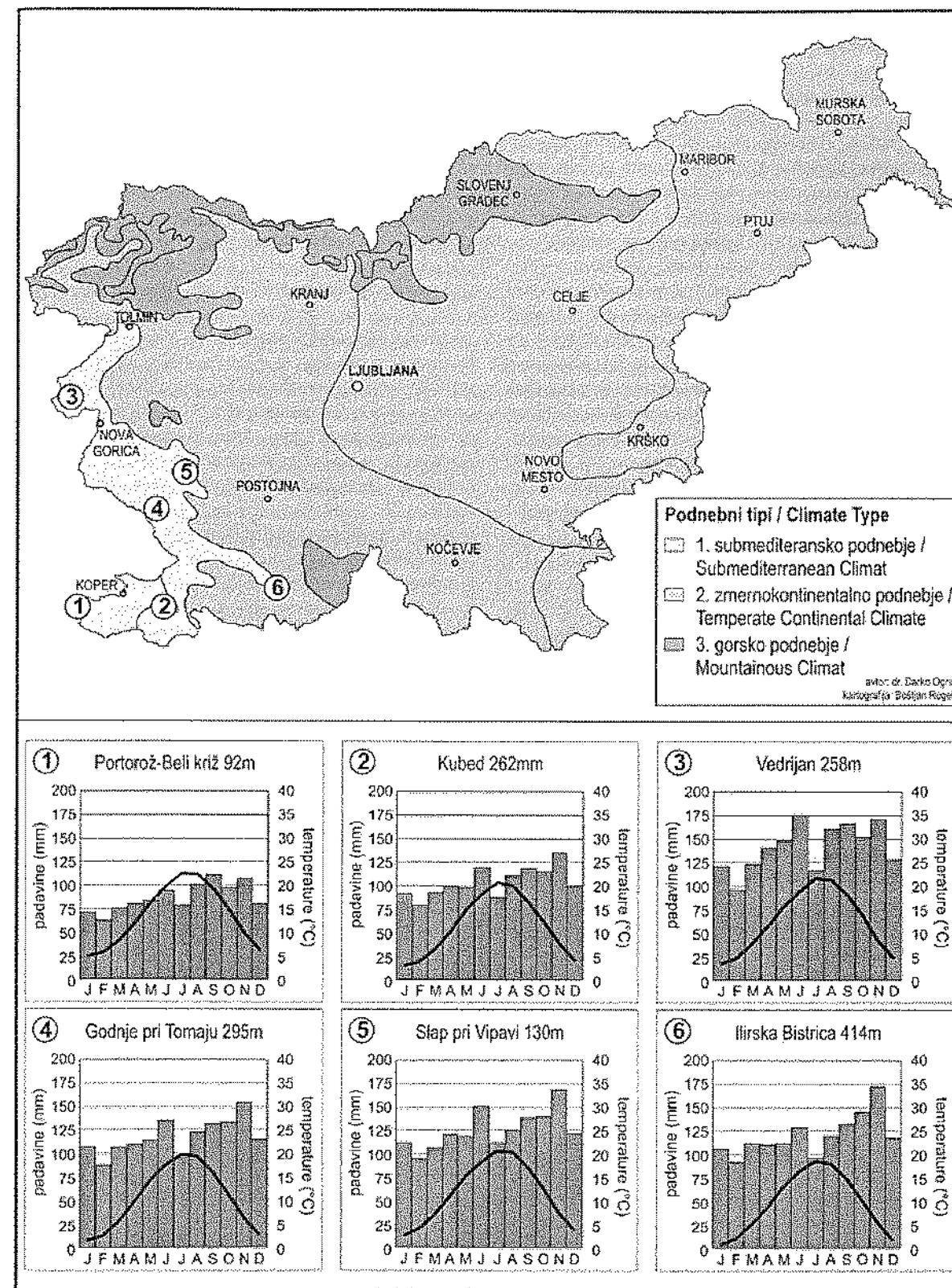

Sl. 1: Podnebni tipi v Sloveniji in klimogrami za nekatere meteorološke postaje v Submediteranski Sloveniji.  
Fig. 1: Climate types in Slovenia and climadiagrams for same meteorologic stations in Submediterranean Slovenia.

SUŠE V SUBMEDITERANSKI SLOVENIJI V  
PREDINSTRUMENTALNEM OBDOBJU

## Metodologija

Suše in moče v Submediteranski Sloveniji v predinstrumentalnem obdobju smo vsaj delno poskusili rekonstruirati s pomočjo kronike izrednih vremenskih dogodkov za Submediteransko Slovenijo (Ogrin, 1994, 1995), ki smo jo sestavili večinoma na podlagi sekundarnih in terciarnih zgodovinskih virov, za prvo polovico 19. stoletja pa tudi s pomočjo primarnih virov o proizvodnji soli v Piranskih solinah (PAK, enota Piran). Kronika zajema predvsem dogodke v Istri, Trstu ter ožjem in širšem zaledju Tržaškega zaliva, vključno s Krasom in Goriško. Izhodišče za oblikovanje naše kronologije je bila kronika vremenskih dogodkov, ki jo je za Trst, Istro in vzhodno Furlanijo sestavil Braun (1934). Njegovi glavni viri so bili anali Jennerja za Trst do leta 1846, kronologija Gorice Della Bonne do leta 1500, Tržaški anali Scusse do leta 1695 in Kandlerja od 1695 do 1848, zgodovina Trsta Irenea della Croceja od leta 1000 do leta 1702, tržaška kronika Mainatija od 11. stoletja do začetka 19. stoletja, anali Di Manzana za Furlanijo, kronika Rovinja Biancinija od leta 1760 do 1806 in Kertov vremenski dnevnik za Trst od leta 1815 do 1858.

Braunovo kroniko (Braun, 1934) smo dopolnili z viri, ki jih avtor ni upošteval, npr. s kroniko Schiavuzzija (1889) in "Fasti Istriani", kroniko dogodkov, ki je izhajala v časopisu "L'Istria" (1846-1852). Črpali smo tudi iz Dolničarjeve ljubljanske kronike 1660-1718 (Pučnik, 1980) in Valvasorjeve "Slave Vojvodine Kranjske" (Valvasor, 1984).

Kronika izrednih vremenskih dogodkov za Submedi-

teransko Slovenijo vsebuje predvsem podatke o hidroloških učinkih vremena (poplave, presihanje studencev in vodnjakov), o posledicah za kmetijstvo (dobre in slabe letine, zgodnje in zapoznelo cvetenje ali zorenje), o ekonomskih učinkih (pomanjkanja, spreminjanje cen, lakote) in o neposrednih vremenskih učinkih (zmrzali, suše, moče, viharji ipd.). Podatkov za obdobje do 16. stoletja je manj in so tudi manj zanesljivi. Več jih je za 17. in 18. stoletje, ko se po dveh ali več neodvisnih virih tudi pokrivajo, kar povečuje njihovo zanesljivost.

## Kronologija suš in moč od 14. do srede 19. stoletja

Kronika izrednih vremenskih dogodkov za Submediteransko Slovenijo je bila narejena za obdobje od 7. stoletja naprej, vendar prvi zapis o suši izvira šele iz prve polovice 14. stoletja (1324). Di Manzanovo poročilo govori, da je v tem letu od marca do konca julija vladala suša, z izjemo obilnega deževja v začetku junija, in da ni padlo skoraj nič dežja od 22. junija do božiča. Zgostitev poročil o suši beležimo od srede 16. stoletja naprej. Na splošno velja, da je zapisov o sušah oziroma mokrih letih neprimerno manj kot npr. zapisov o zmrzalih, kljub temu pa več kot poročil o milih zimah in neurjih. Vesti o sušah se nanašajo predvsem na poletje in zimsko-spomladanski čas, kar kaže na identičnost padavinskega režima v primerjavi s sedanostjo.

Glede na koncentracijo dogodkov lahko izločimo tri obdobja s pogostimi sušami. Prvo je bilo med 1540 in 1562, ko imamo šest poročil (1540, 1546, 1548, 1559, 1561 in 1562). Iz zapisov je razvidno, da je šlo v dveh primerih za sušo v vegetacijski dobi, ki je povzročila veliko težav v vsakdanjem življenju (Tab. 1), enkrat pa za sušo v zimsko-spomladanskem času. V treh primerih pa letni čas ni eksplicitno naveden.

Tab. 1: Zapisi o sušah v obdobju 1540-1562.

Tab. 1: Records of droughts in the 1540-1562 period.

Leto / Year	Opis pojava / Description of phenomena	Vir / Source
1540	Tudi v tem letu je bila na Kranjskem izredno velika vročina in sončna pripeka, da se je od suše ne le zemlja ko kamen strdila, temveč se je dosti gozdov vnelo. Od novembra 1539 do aprila 1540 ni ne deževalo ne snežilo.	Valvasor (1984), Kert (v Braun, 1934)
1546	Huda suša, zaradi katere je v nekaterih predelih Istre odmrlo sadno drevje in bila uničena letina. Suši je sledilo veliko pomanjkanje in lakota.	Schiavuzzi (1889)
1548	Huda suša v Istri.	Schiavuzzi (1889)
1559	Huda suša v Istri. Sušilo se je sadno drevje, uničena je bila letina. Velika suša v Furlaniji, poletje je bilo skoraj brez padavin. Bilo je leto velikega pomanjkanja.	Schiavuzzi (1889), Di Manzano (v Braun, 1934)
1561	Huda suša v Istri.	Schiavuzzi (1889)
1562	Huda suša v Istri.	Schiavuzzi (1889)

V 17. stoletju so bila napravljena štiri poročila o sušah. Leta 1616 je po Fastih Istrianih Istro zajela velika vročina s sušo, da je živina poginjala in so ljudje zbolevali. Za leto 1644 več virov (Ireneo, Mainati, Scussa) (v Braun, 1934) govori o hudi vročini z izredno sušo, ki je uničila vse poljske pridelke v tržaški okolici. Omenjajo tudi, da so se pojavile kobilice, ki so pojedle vse, kar ni uničila suša, celo figove liste. Mainati za leto 1660 poroča o suši pomladi, poleti in jeseni in o velikem pomanjkanju vode, Ireneo pa o suši med 22. septembrom in 24. novembrom 1691, zaradi katere je v Trstu in okolici primanjkovalo vode za pitje, v Žaveljski dolini pa za mletje. Jesenski suši 1660 in 1691 sta prvi poročila o suši v letnem času, ko imamo običajno višek padavin.

Pogosteje so se suše ponovno pojavljale v prvi polovici 18. stoletja. Pet navedb se nanaša na suše v vegetacijski dobi (1704, 1717, 1718, 1735 in 1747), tri (1734, 1737 in 1745) pa na sušo v zimsko-spomladanskih mesecih (Tab. 2). Leta 1748 pa je suša razsajala tako poleti kot pozimi in spomladi.

Iz druge polovice 18. stoletja imamo tri poročila o sušah. Leta 1784 ni po Bianciniju deževalo od 30. aprila do 8. septembra. Po istem viru je bila zelo huda suša, zaradi katere v Istri praktično ni bilo pitne vode, v prvi polovici leta 1794 in tudi spomladi leta 1795. Na splošno je bilo leto 1795 leto vremenskih katastrof, saj je bila zima zelo ostra in so pomrzile oljke. Ostri zimi je sledila suha pomlad. Poleti pa so bili hudi nalivi, ki so uničili žitno letino. Narasle vode so preplavile Sečovo-

veljske soline, svoj tok je spremenila tudi Dragonja.

Po številu poročil o sušah (14) bode v oči tudi prva polovica 19. stoletja, zlasti obdobje od leta 1820 do 1848, v katerem so kronisti zabeležili kar 12 let s sušnimi poletji, kar pomeni, da je bilo vsako drugo do tretje poletje suho (Tab. 3). Pri sklepanju o nadpovprečni sušnosti poletij v prvi polovici 19. stoletja moramo v primerjavi s prejšnjimi stoletji upoštevati dejstvo, da se je v 19. stoletju zelo povečalo število pisnih virov. V našem primeru predvsem po zaslugi Kerta (v Braun, 1934), ki je sistematično vodil vremenski dnevnik za Trst. Leta 1834 ponovno srečamo tudi poročilo o suši oktobra in novembra.

Primerjava Kertovih zabeležk o sušah v 40. tih letih 19. stoletja s podatki meteorološke postaje Trst, ki je začela delovati leta 1841, je pokazala, da moramo biti pri uporabi tovrstnih podatkov previdni oziroma da je problem definicije suše zelo kompleksen. Kert omenja hude suše poleti 1841, 1842 in 1848 ter "običajno" sušo 1843. Čeprav suša ni odvisna samo od količine padavin in števila padavinskih dni, je primerjava s klimatskimi podatki pokazala, da je v primeru suš leta 1841, 1843 in 1848 dejansko padlo v sušnih mesecih le 50 do 60% stoletnega povprečja padavin v pol manj padavinskih dnevih. Ob Kertovi omembi hude suše avgusta in septembra 1842 pa je v teh dveh mesecih padlo celo za 23% več padavin od povprečja v povprečnem številu padavinskih dni. Podrobnejši pregled podatkov pa je zato pokazal, da je pred tem v juniju in juliju padla le okoli tretjina običajnih padavin.

Tab. 2: Zapisi o sušah iz prve polovice 18. stoletja.

Tab. 2: Records of droughts from the first half of the 18<sup>th</sup> century.

Leto / Year	Opis pojava / Description of phenomena	Vir / Source
1704	Nenavadno suho leto. Bilo je veliko (vina) dolenjca, vipavca malo, a dobrega. Na Goriškem je bila poleti, še zlasti avgusta, velika suša, vendar je bilo obilo vina, toda primanjkovalo je vseh vrst žit.	Dolničar (v Pučnik, 1980), Di Manzano (v Braun, 1934)
1717	Trgatev je bila na Goriškem zelo skromna, izjemni pa sta bili vročina in suša.	Di Manzano (v Braun, 1934)
1718	Suho, vroče in zdravo leto. Žita je bilo dovolj, razen ob morju, kjer je bilo pomanjkanje. Sušno vreme je uničilo kmetijske pridelke, grozdje in olive, kar je zelo prizadelo piranske meščane.	Dolničar (v Pučnik, 1980), PAK Piran
1734	Velika suša v prvih treh mesecih v Trstu, do 26. in 27. marca je padlo le nekaj kapelj dežja.	Di Manzano (v Braun, 1934)
1735	Do 24. in 25. septembra ni v Trstu deževalo dva meseca.	Scussa (v Braun, 1934)
1737	Do 18. februarja je v dveh mesecih padlo le malo dežja in vode v vodnjakih je zelo malo.	Scussa (v Braun, 1934)
1745	Od 5. januarja do 11. februarja hud mrz in suša, da je zmanjkovalo vode v nekaterih tržaških vodnjakih.	Scussa (v Braun, 1934)
1747	Poleti vročina in suša.	Scussa (v Braun, 1934)
1748	Od 1. novembra 1747 do avgusta 1748 je zelo redko deževalo. Spomladi in poleti je bila v Trstu velika vročina.	Scussa (v Braun, 1934)



Tab. 3: Suše v prvi polovici 19. stoletja.

Tab. 3: Droughts in the first half of the 19<sup>th</sup> century.

Leto / Year	Opis pojava / Description of phenomena	Vir / Source
1802	Trdovratna suša v prvi polovici pomladi in vse poletje. Ljudje so trpeli zaradi velike vročine, pridelki so bili požgani. V Trstu je primanjkovalo vode.	Mainati*
1820	Od avgusta do septembra suša.	Kert*
1822	V marcu in aprilu ter od junija do avgusta je bila suša.	Kert*
1828	Julija in avgusta huda suša v Trstu.	Kert*
1830	V juliju in avgustu velika vročina in suša.	Kert*
1832	Avgusta je bila huda suša.	Kert*
1833	Januarja in julija je bila suša.	Kert*
1834	Od aprila do avgusta in v oktobru in novembru je bila v Trstu suša.	Kert*
1835	Suša od junija do avgusta.	Kert*
1839	V juliju in avgustu je bila suša.	Kert*
1841	Od julija do septembra huda suša v Trstu.	Kert*
1842	Avgusta in septembra huda suša.	Kert*
1843	Avgusta in septembra je bila suša.	Kert*
1848	Avgusta in septembra huda suša.	Kert*

\* vsi v Braun (1934)

Poročil o deževnih letih (letnih časih) je razmeroma malo, le devet (Tab. 4). Pet se jih nanaša na konec 17. in začetek 18. stoletja. Začetek 18. stoletja lahko opredelimo kot nadpovprečno namočen, saj viri omenjajo leta 1703, 1706, 1711 in 1715 kot nenavadno mokra. Poročili za leti 1691 in 1827 govorita o neobičajnih deževjih v času viškov padavin v submediteranskem podnebjju, prvo v času primarnega viška v jesenskem

času, drugo pa v času sekundarnega viška junija. Poročilo za leto 1801/02 pa govori o zelo vlažni zimi.

Neprimerno več je v kroniki poročil o deževnih ujmah s točo in močnim vetrom v posameznih dnevih in posledicah teh deževij, iz katerih pa ne moremo sklepati o namočenosti posameznih daljših časovnih obdobj. Po teh dogodkih zbuja pozornost zlasti 17. stoletje (12 zapisov) in sredina 18. stoletja (5 zapisov).

Tab. 4: Nadpovprečno namočena leta in letni časi.

Tab. 4: Extraordinary wet years and seasons.

Leto / Year	Opis pojava / Description of phenomena	Vir / Source
1304	Izredno leto po količini snega v Furlaniji.	Della Bona (v Braun, 1934)
1691	24.11.1691 se je začelo 8-dnevno nepretrgano deževje. Sledil mu je šibkejši dež, ki ni ponehal do 16. decembra.	Ireneo (v Braun, 1934)
1703	Nenavadno mokro leto. Bilo je mnogo povodnji. Izjemno leto zaradi nenehnega deževja, prestopanja bregov rek in velike škode, ki so jo vode povzročile v Goriški pokrajini.	Dolničar (v Pučnik, 1980), Di Manzano (v Braun, 1934)
1706	To leto je bilo mokro in jug je neprestano gospodoval. 5. avgusta je grozna nevihta povzročila ogromno škodo na Tržaškem in odvezla ljudem pridelek.	Dolničar (v Pučnik, 1980), Mainati (v Braun, 1934)
1711	To leto je bilo nenavadno mokro, kakor ga ne pomnijo niti najstarejši ljudje. Skoro vse leto je prevladoval jug in je vedno deževalo, razen nekaj časa poleti.	Dolničar (v Pučnik, 1980)
1715	Na splošno mokro leto, ki je sledilo dolgi zimi. Slaba vinska letina.	Dolničar (v Pučnik, 1980)
1801/02	Zelo vlažna zima, ki ji je sledila trovratna suša v prvi polovici pomladi in vse poletje.	Mainati (v Braun, 1934)
1815	Veliko deževje povzroči več nevšečnosti.	Fasti Istriani
1827	Junija nenehno dežuje.	Kert (v Braun, 1934)

### Rekonstrukcija poletnih padavin v prvi polovici 19. stoletja s pomočjo podatkov o pridobivanju soli v Piranskih solinah

Solinarstvo je dejavnost, ki je skoraj v celoti odvisna od vremena, saj vse faze pridobivanja soli potekajo na prostem. Tehnologija pridobivanja soli v Piranskih solinah se je skozi stoletja razmeroma malo spreminjala, zato so podatki o proizvodnji soli lahko dobra osnova za klimatske rekonstrukcije. Osnovni proces pri pridobivanju soli je postopno izparevanje morske vode, dokler koncentracija soli toliko ne naraste, da nastopi kristalizacija. Izparevanje je odvisno od sončnega obsevanja, padavin, števila oblačnih in jasnih dni, vlažnosti zraka in vetrovnosti. Bolj ko je vreme jasno, sončno, suho in vetrovno, večji je pridelek.

Vremenske in podnebne razmere v severnem Jadranu omogočajo začetek solne sezone v aprilu ali v začetku maja, traja pa do septembra oziroma prvega večjega deževja ob koncu poletja. Jedro solne sezone sestavljajo trije poletni meseci. Ob razmeroma stabilnih družbenih razmerah proizvodnje (površina kristalizacijskih bazenov, delovna sila, vzdrževanost solin, tudi omejitve proizvodnje kot posledica državnega monopola, gospodarske in politične razmere) je variiranje proizvodnje v visoki korelaciji s potekom vremena v času solne sezone, predvsem padavinskimi razmerami. V dveh testnih obdobjih (1926-1936 in 1961-90), ko je imel na voljo tako podatke o vsakoletni proizvodnji soli kot o količini padavin in številu padavinskih dni, je Ogrin (1995) izračunal, da lahko s padavinskimi parametri pojasnimo od 52 do 85% variance proizvodnje soli. Večji delež pojasnjene variance je bil ugotovljen za obdobje med obema svetovnjima vojnama, ko so bile družbene razmere za proizvodnjo stabilnejše.

Solinarstvo v Piranu ima po nekaterih virih (npr. Pahor & Poberaj, 1964) tisočletno tradicijo. Podatki za zgodnejša stoletja so bolj fragmentarni in težko dosegljivi, več jih je in so lažje dosegljivi za zadnja stoletja. Za rekonstrukcijo klimatskih razmer so predvsem zanimiva obdobja, ko proizvodnja soli zaradi državnih monopolov ni bila omejena, ampak je trajala, dokler so to dopuščale vremenske razmere. Eno takih je bilo obdobje med 1749 in 1823. Kontinuirane podatke nam je uspelo dobiti za čas med 1791 in 1823 (Nicolich, 1882; PAK enota Piran). Po letu 1824 je bilo pridobivanje soli omejeno.

Rekonstrukcija za to obdobje (Sl. 2), pri kateri smo upoštevali že prej ugotovljene statistične zveze med proizvodnjo soli in padavinskimi razmerami in kjer smo vsakoletno proizvodnjo preračunali na enoto kristalizacijske površine, je pokazala dve obdobji z bolj suhimi in tri obdobja z bolj deževnimi poletji. Suha poletja z ugodnimi razmerami za izparevanje morske vode so bila med 1808 in 1811, še bolj sušna pa med 1818 in 1822. V kronikah ni kakih posebnih zabeležb o suhih

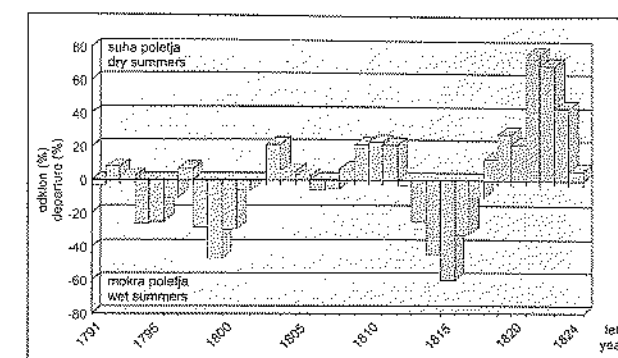

Sl. 2: Rekonstrukcija poletnih padavin s pomočjo podatkov o proizvodnji soli v Piranskih solinah v obdobju 1791-1824.

Fig. 2: Reconstruction of summer precipitation with the aid of data on salt production at Piran salt pans in the 1791-1824 period.

poletjih med 1808 in 1811. Le Nicolich (1882) omenja, da je bilo v času Ilirskih provinc (1809 do 1813) vreme za pridobivanje soli na splošno ugodno. Za rekonstruirano sušno obdobje 1818-1822 kronike navajajo kot sušno leto 1820. Poročila o pridobivanju soli, kjer so večinoma na kratko opisane tudi vremenske razmere, omenjajo kot suho tudi leto 1822, medtem ko so bile v drugih letih zelo ugodne razmere za pridobivanje soli samo v delu solne sezone.

Po naši rekonstrukciji so bila deževna poletja med 1794 in 1796, med 1798 in 1800 ter med 1812 in 1817. Za prvo obdobje kronike omenjajo močna deževja s povodnji po 20. juniju 1795. Telega leta so v Piranskih solinah proizvedli slabo tretjino povprečne proizvodnje. Še pogostejša so bila deževja poleti 1799. Nicolich (1882) navaja, da je bila žetev soli dejansko povsem onemogočena, saj so proizvedli le 0,4% običajne količine. Deževna poletja med 1812 in 1817 potrjujejo tudi zapisi v arhivskem gradivu. Velika deževja omenjajo v letu 1815, prav tako leta 1816, ko so "vode s hribovja" in visoko morje preplavili soline. Poplavljen so bile tudi avgusta 1817, ko so morali že avgusta prekiniti s solno sezono.

### ZAKLJUČEK

Razmeroma pogoste suše v zadnjem desetletju v Submediteranski Sloveniji so sprožile razmišljanja o nenavadni pogostosti tega pojava. Vzroke za to smo velikokrat iskali tudi v antropogenem efektu tople grede in zadržanih spremembah, povezanih z njim. Kratka in za zdaj nepopolna kronologija pojavljanja suš v preteklih stoletjih pa je pokazala, da so se zgostitve suš v posameznih obdobjih pojavljale tudi v preteklosti, ko človekovi vplivi na klimo še niso bili tako izraziti. Taka obdobja so bila 1540-1562, prva polovica 18. stoletja in





**Sl. 3:** Ob suši poleti 1999 so hrasti puhavci (*Quercus pubescens*) na Podgorskem krasu prešli v obdobje mirovanja (listje je porjavelo), po dežju sredi septembra pa so odgnali novi listi. (Foto: D. Ogrin)  
**Fig. 3:** During the 1999 drought, Downy Oaks (*Quercus pubescens*) in the Karst area of Podgorje passed into a dormancy period (leaves turned brown), but after the mid-September rainfall new leaves appeared. (Photo: D. Ogrin)

čas med 1820 in 1848. Nekatera poročila (mnogične invazije kobilic žerk) pa napeljujejo na misel, da je bilo v posameznih krajših obdobjih morda celo bolj sušno in vroče kot v zadnjih letih, razmere naj bi bile podobne subtropskim, od koder kobilice izvirajo. Kronisti so "napade" kobilic zabeležili leta 1442 in 1475, iz katerih sicer nimamo sočasnih poročil o suhih in vročih razmerah, pač pa se časovno ujemajo invazije kobilic s sušami in vročinami leta 1644, 1720 in 1741. V zadnjem desetletju so v južni Evropi invazije kobilic doživeli na Siciliji in v Španiji.

Glede na pojavljanje suš po letnih časih lahko sklepamo, da je bil padavinski režim v preteklih stoletjih identičen današnjemu. Velika večina poročil o sušah se namreč nanaša bodisi na vegetacijsko dobo (poletje) (Sl. 3) bodisi na zimske oziroma zgodnje spomladanske mesece, to je na čas, ko imamo tudi v sedanjem submediteranskem podnebnju nižka padavin. Na nespre-

menjenost padavinskega režima kažejo tudi zabeležbe o močah, ki se večinoma nanašajo bodisi na jesenske mesece bodisi na zgodnje poletje, ko v povprečju nastopata sedanja viška padavin. Mokra leta (sezona) so glede na zabeležbe v arhivskih virih redkejši pojav. Obdobje z njihovo večjo koncentracijo je bilo le v začetku 18. stoletja med 1703 in 1715. Močam so v nadaljevanju prve polovice 18. stoletja sledile suše, kar je izjemno poslabšalo življenjske razmere v tem času.

Predstavljena kronologija suš in moč v Submediteranski Sloveniji ne omogoča popolne klimatske rekonstrukcije, ker je podatkov premalo. Po zbranim gradivam lahko le sklepamo na določene tendence klime, a je vsekakor osnova za nadaljnje raziskave v tej smeri. Za rekonstrukcijo padavinskih razmer poleti se zdi še posebej perspektivno arhivsko gradivo o proizvodnji soli v istrskih solinah.

## DRY AND WET YEARS IN SUBMEDITERRANEAN SLOVENIA FROM THE 14<sup>th</sup> TO THE MID-19<sup>th</sup> CENTURIES

Darko OGRIN

Department of Geography, Faculty of Arts, University of Ljubljana, SI-1000 Ljubljana, Aškerčeva 2  
 E-mail: Darko.Ogrin@ff.uni-lj.si

### SUMMARY

The quite frequent occurrence of droughts in Submediterranean Slovenia in the last decade raised a number of questions about the extraordinary frequency of this phenomenon during this particular time. The causes for such state of affairs have been often searched for in the anthropogenic greenhouse effect and its related climatic changes. However, a short and still incomplete chronology of droughts in the past centuries has shown that the concentration of droughts in individual periods had occurred already in the past, when human impacts on climate had not been so explicit as yet. Such periods were from 1540 to 1562, in the first half of the 18<sup>th</sup> cent., and from 1820 to 1848. Certain reports (on locusts, for example) have brought us to a conclusion that individual shorter periods in the past were even dryer and hotter than those in the last few years; the climate conditions then seem to have been similar to the subtropical climate, where locusts came from. The chroniclers recorded the invasions by locusts in 1442 and 1475, but did not record dry and hot weather concurrently; however, the locust invasions in 1644, 1720 and 1741 overlap with the reported droughts and hot weather.

From the reconstructed occurrence of droughts in individual seasons we can conclude that the precipitation regime of the past centuries has been identical to the present regime. Namely, the great majority of reports on drought refer to the vegetation period (summer), or to the winter or early spring months. These are the very periods when precipitation minimum occurs in the present submediterranean climate as well. The unchanged characteristics of the precipitation regime are also evident from the records on wet seasons, which mainly refer to the autumn months or early summer. These are also the periods when, on average, precipitation maximums occur in the present submediterranean climate. Wet years (seasons) were less frequent according to the records from archival sources. The period of their greater concentration was at the beginning of the 18<sup>th</sup> cent., from 1703 to 1715. Wet periods were then followed by droughts in the first half of the 18<sup>th</sup> cent., which greatly impaired the living conditions of that time.

Because of the lack of data, the presented chronology of droughts and wet seasons in Submediterranean Slovenia does not render possible a complete climatic reconstruction. The collected material only enables some conclusions to be made about certain trends in the climate; nevertheless, it certainly represents a firm basis for further investigations in this particular field. Especially promising for the reconstruction of precipitation conditions in the summer seems to be the archival documents on salt production in Istrian salt pans.

**Key words:** drought, climate variation, climatology, Submediterranean Slovenia, Slovenia

### LITERATURA

- Anonymous (2001):** Prvo poročilo Konferenci pogodbenic Okvirne konvencije ZN o spremembi podnebja. MOP R Slovenije, Ljubljana, 91 str.
- Braun, G. (1934):** Notizie meteorologiche e climatologiche della Regione Giulia (Trieste, Istria e Friuli Orientale). Consiglio Nazionale della Ricerche, Roma, 80 pp.
- Dolinar-Lešnik, M. (1989):** Vpliv suše na kmetijsko proizvodnjo. Ujma, 3, 7-9.
- Fasti Istriani (ur. Kandler):** L'Istria. Trst, 1846-1852.
- Gams, I. (1998):** Vreme, sončno obsevanje in temperature. V: Gams, I. & I. Vrišer (ur.): Geografija Slovenije. Slovenska matica, Ljubljana, str. 91-116.

- Gams, I. (1999):** Spremenljivi sezonski padavinski režim in njegov vpliv na suše in povodnji. Ujma 13, 195-198.
- Kajfež-Bogataj, L. (1998):** Bo suša v Sloveniji bolj pogosta? Gea, 8-9, str. 69.
- Klimatografija Slovenije (1995):** Padavine 1961-90. Hidrometeorološki zavod R Slovenije, Ljubljana, 366 str.
- Klimatografija Slovenije (1995):** Temperatura zraka 1961-90. Hidrometeorološki zavod R Slovenije, Ljubljana, 356 str.
- Matajc, I. (1991):** Suša v kmetijstvu in namakanje. Ujma, 5, 153-156.
- Matajc, I. (1995):** Kmetijska suša in namakanje v Prekmurju leta 1994. Ujma, 9, 55-85.
- Matajc, I. (1996):** Vpliv sušnih in deževnih obdobj na pridelavo kmetijskih rastlin. Ujma, 11, 138-142.

- Matajc, I. (2002):** Suše. V: Ušeničnik, B. (ur.): Nesreče in varstvo pred njimi. Uprava RS za zaščito in reševanje, Ministrstvo za obrambo, Ljubljana, str. 297-302.
- Natek, K. (1987):** Suša v Sloveniji. Ujma, 1, 39-46.
- Nicolich, E. (1882):** Cenni Storico-statistici sulle saline di Pirano. Trst, 108 pp.
- Ogrin, D. (1994):** Modern Age Climatic Fluctuations in the Area of the Gulf of Trieste. Geografski zbornik, 34, 5-80.
- Ogrin, D. (1995):** Podnebje Slovenske Istre. Knjižnica Annales 11, Koper, 320 str.
- Ogrin, D. (1996):** Podnebni tipi v Sloveniji. Geografski vestnik, 68, Ljubljana, 39-56.
- Ogrin, D. (2002):** Podnebje (Slovenije). V: Ušeničnik, B. (ur.): Nesreče in varstvo pred njimi. Uprava RS za zaščito in reševanje, Ministrstvo za obrambo, Ljubljana, str. 29-34.
- Pahor, M. & T. Poberaj (1964):** Stare Piranske soline. Spomeniški vodniki 4, Ljubljana, 175 str.
- Pristov, J. (1994):** Namočenost in evapotranspiracija v Sloveniji. Ujma, 8, 169-173.
- Pučnik, J. (1980):** Velika knjiga o vremenu. Cankarjeva založba, Ljubljana, 366 str.
- Schiavuzzi, B. (1889):** La Malaria in Istria. Atti e memorie della Società Istriana di Archeologia e Storia patria, Parenzo.
- Valvasor, J. V. (1984):** Slava Vojvodine Kranjske. Izbrana poglavja. Ljubljana, 1-339.
- Vrhovec, T. (2002):** Padavine (v Sloveniji). V: Ušeničnik, B. (ur.): Nesreče in varstvo pred njimi. Uprava RS za zaščito in reševanje, Ministrstvo za obrambo, Ljubljana, str. 42-46.

RAZISKAVE SLADKIH VODA  
RICERCHE DI ACQUE DOLCI  
FRESHWATER RESEARCH



original scientific article  
received: 2003-04-18

UDK 551.312.2:582.623(439)

## A PRELIMINARY REPORT ON A NEW TYPE OF FLOATING MIRE FROM HUNGARY

János NAGY & Zoltán TUBA

Department of Botany and Plant Physiology, Faculty of Agricultural and Environmental Sciences, Szent István University, Gödöllő,  
H-2103 Gödöllő, Péter K. u. 1  
E-mail: nagyjano@yahoo.com

### ABSTRACT

The authors studied the vegetation dynamics of Sphagnum dominated mires in the Bereg-plain (northeastern Hungary). The Braun-Blanquet method was applied and a new type of floating mire described. The authors suggest the name "skirt-mire" after its shape and preliminary present it in this paper. This widespread scraw formation process is observable on flooded willow mires, when willow trunks and branches grow long, bushy and hair-like additional roots close to the water surface. In the water, the abundant small floating dead plant debris mat not only with each other but also with the hairy-like willow roots and the plants at the bottom. The succession was very fast on its surface.

**Key words:** Floating mire, scraw, skirt-shaped mire, carr, *Sphagnum*, Hungarian-plain, temperate climate, continental climate

## RAPPORTO PRELIMINARE SU UN NUOVO TIPO DI ACQUITRINO FLUTTUALE IN UNGHERIA

### SINTESI

Gli autori hanno condotto una serie di ricerche fitocenologiche in acquitrini della pianura di Bereg (Ungheria nord-orientale), nei quali predomina il genere *Sphagnum*. Con l'applicazione del metodo di Braun-Blanquet è stato descritto un nuovo tipo di acquitrino fluttuale. Gli autori suggeriscono il nome di "acquitrino tendato", vista la sua forma, e nel presente articolo ne danno una descrizione preliminare. In seguito ad allagamento, tutte le specie di salici studiate (*Salix cinerea*, *Salix pentandra*, *Salix fragilis*, *Salix alba*, *Salix aurita* ed i loro ibridi) formano radici avventizie che crescono sotto la superficie dell'acqua. Su queste lunghe radici ramificate si depositano enormi quantità di detriti organici provenienti da piante morte, risultando in una formazione "a tenda" che raggiunge il fondo dell'acquitrino. La successione vegetale è risultata molto veloce.

**Parole chiave:** acquitrino fluttuale, salici, acquitrino tendato, *Sphagnum*, pianura ungherese, clima temperato, clima continentale

INTRODUCTION

There are several types of floating vegetation formation (Sculthorpe, 1985) occurring mainly as a tropical phenomenon known as sudd (sadd) or floatant, which according to Sculthorpe (1985) forms in two main ways.

Sudd may be pioneered by free floating plants, such as *Eichornia crassipes* and *Pistia stratiotes*, whose stoloniferous habit creates a compact floating mat spreading from sheltered marginal sites out over open water. This mat of living plants and organic debris provides a favourable rooting medium for emergent hydrophytes.

Sudd may also develop directly from fringing stands of emergent sedges extending from the shore in calm shallows. The rhizomes and roots do not become anchored in the substrate, but form a stable raft floating at a depth of a few centimetres.

By definition of Steffen (1931), the first type is like a **successional** formation of floating meadow, which develops where the water has steep banks and where the open water surface is gradually overgrown by floating or submerged aquatics.

The second type is a **simultaneous** formation of floating meadow (Steffen, 1931). This can be observed on shallow margins of the water, where rhizomes of waterside plants (e.g. *Phragmites australis*, *Typha angustifolia*, *Schoenoplectus lacustris* in temperate zone) are creeping on and where rooting in the bottom sediments continues into the open water as a self-supporting rhizome mat (Steffen, 1931; Kulczynski, 1949; Dansereau, 1957; Junk, 1970; Sioli, 1975; Lájer, 1998; Balogh, 2000a, b). However, data on the floating mire formation in *Sphagnum* dominated mires under temperate, continental conditions are sparse.

During our phytocoenological research between 1992 and 2002 on the *Sphagnum* dominated mires of the Northeast Plain in the continental temperate climate in Hungary we observed many similar and some different (and hitherto undescribed) processes of floating mire formation, which can also be found in other parts of Hungary. In this preliminary paper we present till now undescribed but widespread floating mire type.

MATERIAL AND METHODS

The study site

The investigated mires (Bence-tó 48°8'55" N, 22°25'35" E; Nyíres-tó 48°11'3" N, 22°30'6" E; Navad-patak 48°10'32" N, 22°30'45" E; Báb-tava 48°11'16" N, 22°29'0" E; Zsid-tó 48°11'87" N, 22°29'6" E) lie in the northeastern corner of the Great Hungarian Plain in Hungary on the Bereg-Szatmár Plain in Bereg-Szatmár County (East-Central Europe). These mires belong to the *Samicum* plant-geographical region. The mires have formed in abandoned riverbeds (silted oxbows), in a ring indicated

by Beregdaróc, Gelénes, Tákos, and Csaroda villages (Fig. 1). The fieldwork has been carried out since 1994.

In the Köppen (1923) system, the climate of the study area is Cbfx (between moderate warm and moderate cool). The mean annual number of sunny hours is ca 1950, while the annual mean temperature oscillates between 9.4 and 9.5 °C. Yearly precipitation is 630-660 mm, with 370-380 mm during the growing season (Marosi & Somogyi, 1990). The distribution and amount of precipitation and the ground water level can vary greatly in successive years.

Methods

The Braun-Blanquet method (1951) was used to describe the vegetation dynamics. In the sample plots, species by species on a percentage scale was estimated in the case of higher plants in all of the associations. In the middle of the flooded willow and alder carr, we could proceed only on foot, swimming or by mud-walking.

We used an Irish word, "scraw", for floating mires. The coenological examinations were made in this way, which provided an opportunity to observe the mechanism of formation of the scraw. The size of the scraws was estimated by eye. Here we give the relevant interpretation of our observations.

Taxonomical and syntaxonomical nomenclature follows Simon (1992).

RESULTS AND DISCUSSION

After natural or artificial floods, the peatmoss cushions were submerged in base-rich water and failed to survive. On these former peatmoss mires secondary scraw formation processes could be observed, whose first stage was named "skirt-mire" after its shape. They develop as follows (Fig. 2): all the willow species (*Salix cinerea*, *S. pentandra*, *S. fragilis*, *S. alba*, *S. aurita* and their hybrids) that can be found in the examined areas are able to develop adventitious roots from their shoots near the water surface after flooding. Root formation is independent of the age of the shoots of the willow species (Fig. 3). The dead broken fragments of plants floating in large quantities in the mire water mat with each other, with the long and bushy hair-shaped willow roots of stem origin and with the plant residues at the bottom of the lake. Thus a matted carpet forms, which falls as a "skirt" from the water surface to the bottom of the lake. The broken fragments deposited in the water enlarge mainly the bottom of the skirt, as the movement of the water erodes more strongly the parts near the water surface. In the first summer of their formation, the thickness of the skirts near the surface are therefore only a half to a third (20-30 cm) of that at the bottom of the bed (40-70 cm). These skirts average 3-6 m in diameter in the areas examined around individual *Salix cinerea* shrubs.

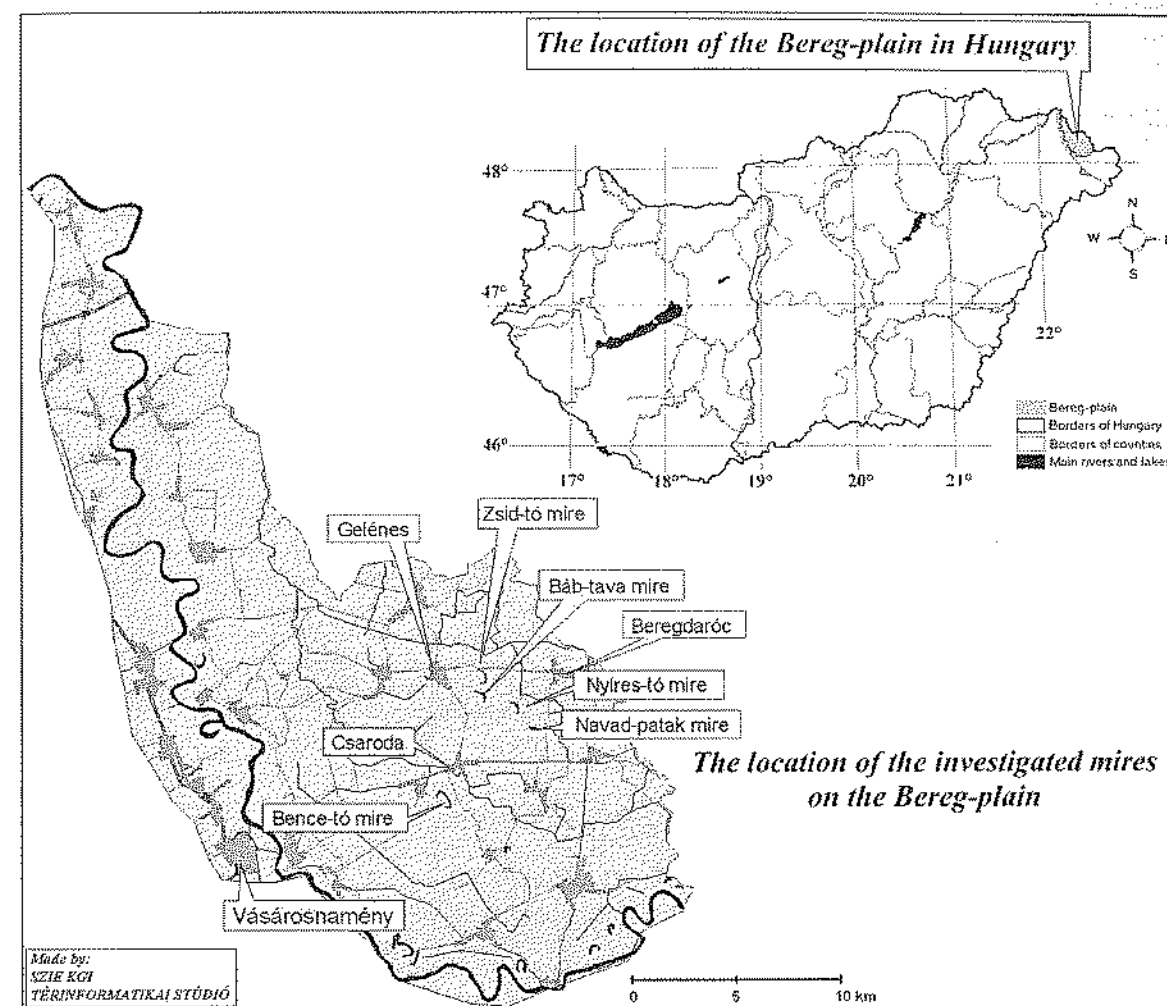

Fig. 1: Location of the studied area.

Sl. 1: Lokacija preučevanega območja.

The skirts can be formed around numerous willows as well, forming several ten square metres large scraws. Such mat-like scraws can be observed in the dense *Glycerietum maximae* among the leaves of the bottom rooted *Glyceria maxima* specimens of the stands. Water under the skirt is much colder than around it. The first colonists that can be found on the surface of the scraw include *Cicuta virosa*, *Carex pseudocyperus*, *Galium palustre*, *Lycopus europaeus*, *Poa palustris*, *Glyceria maxima*, *Thelypteris palustris*, *Polygonum lapathifolium* or *Typha latifolia*, *Typha angustifolia*, as well as drifted *Salvinia natans*, *Hydrocharis morsus-ranae*, *Lemna minor* and sometimes *Stratiotes aloides*, and *Oenanthe aquatica*. Sometimes, *Cicuta virosa* and *Glyceria maxima* may be missing from these bare surfaces in the first year.

In the second year, the *Cicuto-Caricetum pseudocyperiperi* becomes almost predominant on the skirt-mires, but its dominance decreases gradually in the next few years.

For a few years, rhizomatous, emergent species, mainly *Glyceria maxima*, *Thelypteris palustris*, and *Lythrum salicaria* and occasionally *Comarum palustre* will be dominant (Tab. 1). The plants of the initial state can be seen just on the growing edge of the scraws. Concentric structure of the floating mire develops.

CONCLUSIONS

The skirt-mire formation briefly outlined above has not been described yet in literature, although it can be observed in Hungary in many willow swamps flooded with water, and it is probably widespread where conditions (willows, water flooding, floating plant debris suitable for matting) are suitable. We found similar processes near the study site in Bodrogköz, NE Hungary. It is worthy of note that scraws can be formed in any place where peat forming-plants are able to settle, survive and propagate on living or lifeless substratum on the surface of the water.

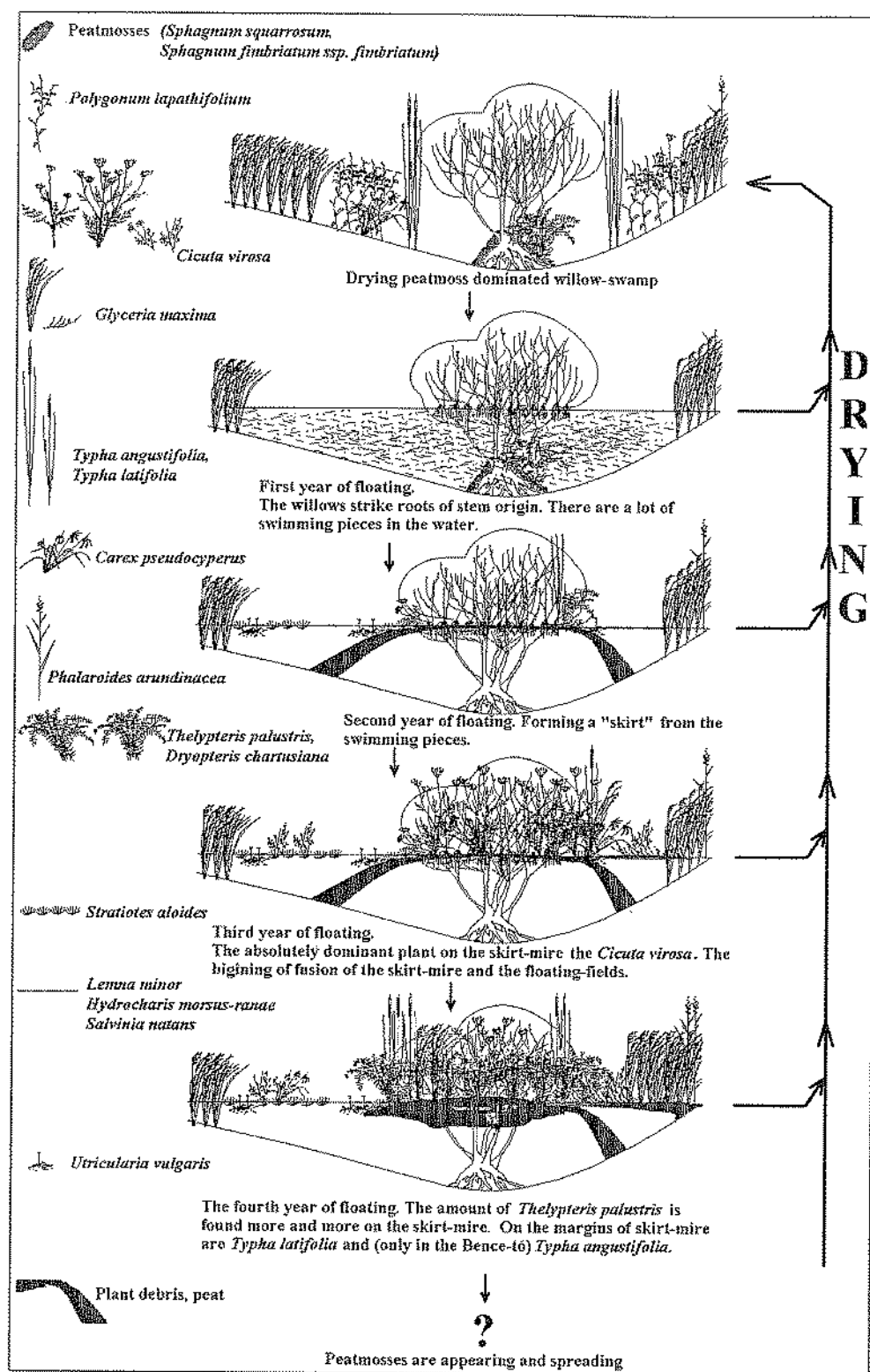

Fig. 2: Scheme of the formation and the succession of the skirt-mires in their first four years in Bence-tó mire, NE Hungary, between 1998-2002.

Sl. 2: Shema nastajanja in sukcesije "zavesastih" barij v prvih štirih letih. Barje Bence-tó, SV Madžarska, med letoma 1998 in 2002.

Tab. 1: Phytosociological relevés of different skirt-mires (Bereg-plain, NE Hungary).  
Tab. 1: Fitosociološki popisi različnih "zavesastih" barij (pusta Bereg, SV Madžarska).

Place of samples	Navad-patak mire		Zsid-tó mire			Bence-tó mire	
	17.07.1997	17.07.1997	29.07.1999	29.07.1999	29.07.1999	14.07.2000	14.07.2000
Date	~ 3 years	~ 3 years	~ 5 years	~ 5 years	~ 5 years	~ 2 years	~ 2 years
Age of the skirt-mire	9 m <sup>2</sup>	9 m <sup>2</sup>	25 m <sup>2</sup>	25 m <sup>2</sup>	25 m <sup>2</sup>	9 m <sup>2</sup>	9 m <sup>2</sup>
Plot size	Cover (%)						
Shrub level	Salix pentandra						
Salix pentandra	Frangula alnus						
Frangula alnus	40	25	90	5	10	3 (dead)	5 (dead)
Salix cinerea	Herb level						
Herb level	Bidens cernua						
Bidens cernua	Carex pseudocyperus						
Carex pseudocyperus	Carex riparia						
Carex riparia	Cicuta virosa						
Cicuta virosa	Comarum palustre						
Comarum palustre	Galium palustre						
Galium palustre	Glyceria maxima						
Glyceria maxima	Hydrocharis morsus-ranae						
Hydrocharis morsus-ranae	Lemna minor						
Lemna minor	Lythrum salicaria						
Lythrum salicaria	Lycopus europaeus						
Lycopus europaeus	Lysimachia vulgaris						
Lysimachia vulgaris	Oenanthe aquatica						
Oenanthe aquatica	Polygonum lapathifolium						
Polygonum lapathifolium	Salix cinerea						
Salix cinerea	Salvinia natans						
Salvinia natans	Scutellaria galericulata						
Scutellaria galericulata	Solanum dulcamara						
Solanum dulcamara	Sparganium erectum						
Sparganium erectum	Stratiotes aloides						
Stratiotes aloides	Thelypteris palustris						
Thelypteris palustris	Typha angustifolia						
Typha angustifolia	Typha latifolia						
Typha latifolia	Utricularia vulgaris						
Utricularia vulgaris							

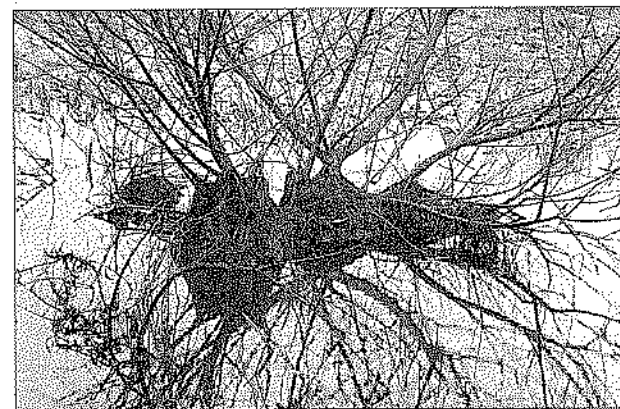

Fig. 3: First phase of the skirt-mire formation: branches of Salix cinerea develop adventitious roots (Bence-tó mire, NE Hungary, 30 March 2000). (Photo: J. Nagy)  
Sl. 3: Prva faza oblikovanja "zavesastega" barja: veje vrste Salix cinerea razvijajo adventivne korenine (barje Bence-tó, SV Madžarska, 30. marec 2000). (Foto: J. Nagy)

The vegetation changes of the skirt-mires are very quick and to a great extent conditioned by the rhythm and rate of the water supply (Nagy, 2002). The water retention peat forming process takes place on terrestrial mire in dry periods and on floating mires in wet periods. When developing an adequate peat thickness, it can counterbalance the effect of fluctuation of the water supply under the established plant communities.

ACKNOWLEDGEMENTS

The authors are indebted to Prof. Dr. Michael C. F. Proctor and Dr. Márton Balogh for their useful advice and suggestions and to Mrs. Katalin Réti for checking the English text. Financial support by the Directorate of the Hortobágy National Park (Debrecen) is acknowledged.



## PRELIMINARNO POROČILO O NOVEM TIPU "ZAVESASTEGA" BARJA NA MADŽARSKEM

János NAGY &amp; Zoltán TUBA

Department of Botany and Plant Physiology, Faculty of Agricultural and Environmental Sciences, Szent István University, Gödöllő,  
H-2103 Gödöllő, Péter K. u. 1  
E-mail: nagyjano@yahoo.com

## POVZETEK

Med letoma 1992 in 2002 sta avtorja opravila vrsto fitocenoloških raziskav barj s prevladujočim šotnim mahom *Sphagnum* (*Nyíres-tó*, *Báb-tava*, *Navad-patak*, *Zsid-tó* in *Bence-tó*) v madžarski pusti Bereg. V omenjenem obdobju sta preučevala doslej neopisani in v tem članku preliminarno orisani proces oblikovanja tako imenovanega "zavesastega" barja, potem ko je bila naravno ali umetno poplavljenjena njegova vrbovina. Vse preučevane vrste vrb (*Salix cinerea*, *S. pentandra*, *S. fragilis*, *S. alba*, *S. aurita* in njihovi hibridi) po poplavljenju poženejo adventivne korenine iz svojih poganjkov pod vodnim površjem. Oblikovanje korenin je neodvisno od starosti poganjkov in vrste vrb.

Na teh dolgih, košatih, lasastih koreninah se v vodi odmrli delci rastlin v velikih količinah prepletajo in spajajo med seboj, z vrbjimi koreninami stebelstega izvora in z rastlinskimi ostanki na vodnem dnu. Tako se oblikuje nekakšna "zavesa", ki s korenin, rastočih iz vrbjih stebel na vodnem površju, pada vse do vodnega dna. Med prvimi naseljenci, ki jih je mogoče najti na površju zaves, so *Cicuta virosa*, *Carex pseudocyperus*, *Galium palustre*, *Lycopus europaeus*, *Poa palustris*, *Glyceria maxima*, *Thelypteris palustris*, *Polygonum lapathifolium* ali *T. latifolia*, *Typha angustifolia* kot tudi *Salvinia natans*, *Hydrocharis morsus-ranae*, *Lemna minor* ter včasih *Stratiotes aloides* in *Oenanthe aquatica*. V prvem letu lahko s teh golih površij izgineta *Cicuta virosa* in *Glyceria maxima*. V drugem letu postane *Cicuta virosa* skorajda dominantna vrsta v teh "zavesastih" barjih, vendar se njena prevlada v naslednjih nekaj letih sčasoma zmanjša. Takrat začnejo prevladovati plezajoče (rizoidne) vrste (*Glyceria maxima*, *Thelypteris palustris*, *Lythrum salicaria* in *Comarum palustre*). Rastline v začetnem stadiju je mogoče videti le na rastočem robu zaves, in v barju se začnejo oblikovati koncentrične strukture. Vegetacijske spremembe v "zavesastih" barjih so zelo hitre ter močno odvisne od ritma in stopnje vodnega dotoka.

**Ključne besede:** "zavesasto" barje, vrbovina, *Sphagnum*, madžarska pusta, zmerna klima, celinska klima

## REFERENCES

- Balogh, M. (2000a):** Classification of mires. In: Szurdoki, E. (ed.): *Sphagnum* dominated habitats in Hungary. Research, Management, Conservation. CEEWEB, Munkacsport, Miskolc, p. 57-65.
- Balogh, M. (2000b):** The problems of the succession of floating mires I. *Kitaibelia*, 5, 9-16. (in Hung. with Eng. Summary)
- Braun-Bianquet, J. (1951):** Pflanzensoziologie. (Plant-sociology). Springer Verlag, Wien.
- Dansereau, P. (1957):** Biogeography. An ecological perspective. The Ronald Press Co., New York.
- Junk, W. (1970):** Investigation on the "Floating Meadows" (*Paspalo-Echinochloetum*) on the middle Amazon. Part 1. The Floating vegetation and its ecology. *Amazoniana*, 2, 449-495.
- Köppen, W. (1923):** Die Klimate der Erde. Walter de Gruyter, Berlin.
- Kulczyński, S. (1949):** Peatbogs of Polesie. *Memories de L'Academie Polonaise des Sciences et de Letters, Cracovie*.
- Lájer, K. (1998):** Bevezetés a magyarországi lópok vegetáció ökológiájába. (Introduction to the vegetation-ecology of the Hungarian mires). *Tilia*, 6, 84-238. (in Hung.)
- Marosi, S. & S. Somogyi (1990):** Magyarország kistájainak katasztere. (Cadastral of microregions of Hungary) MTA Földrajztudományi Kutató Intézet, Budapest. (in Hung.)
- Nagy, J. (2002):** Research of syndinamical processes for conservation of natural values of a *Sphagnum* mire. Ph.D thesis, Gödöllő. (in Hung. with Eng. Summary)
- Sculthorpe, C. D. (1985):** The Biology of Aquatic Vascular Plants. Königstein: Koeltz Scientific Books.
- Simon, T. (1992):** A magyarországi edényes flóra határozója. *Harasztok - virágos növények*. (Handbook of the Hungarian vascular flora). Tankönyvkiadó, Budapest. (in Hung.)
- Sioli, H. (1975):** Tropical river: the Amazon. In: Whitton, B.A. (ed.): *River Ecology*. Blackwell Science Publications, Oxford, London, Edinburgh, Melbourne.
- Steffen, H. (1931):** Vegetationskunde von Osteuropa. (Vegetation science of East-Europe.) Gustav Fischer Verlag, Jena.

original scientific article  
received: 2003-01-25

UDK 582.26(282.24 Dragonja)

## ALGAE IN DRAGONJA RIVER

Aleksandra KRIVOGRAD KLEMENČIČ  
SI-1290 Grosuplje, Čušperk 51

Danijel VRHOVŠEK  
Limnos d.o.o., SI-1000 Ljubljana, Podlimbarskega 31  
E-mail: info@limnos.si

Gorazd KOSI  
Nacionalni inštitut za biologijo, SI-1001 Ljubljana, Večna pot 111

## ABSTRACT

Between 1998 and 2000, peryphytic algal communities were sampled and analysed at five sampling sites on the Dragonja river and at a single site on the tributary Pinjevec. Altogether, 238 algal taxa were registered, with prevailing Bacillariophyceae (170), while 38 taxa belonged to Cyanophyceae and 17 to Chlorophyceae. Of all 238 taxa, 65 were recorded for the first time in Slovenia, 13 belonging to Cyanophyceae and 52 to Bacillariophyceae. Most of these 65 taxa were recorded in the Dragonja estuary.

**Key words:** algae, streams, springs, brackish waters, southwestern Slovenia

## ALGHE NEL FIUME DRAGOGNA

## SINTESI

Tra il 1998 ed il 2000 sono state campionate ed analizzate comunità perifitiche algali in cinque stazioni di campionamento nel fiume Dragogna ed una stazione nel tributario Pinjevec. Sono stati trovati 238 taxa algali. Il contributo maggiore proviene dalla famiglia delle Bacillariophyceae (170 specie); 38 taxa appartengono alle Cyanophyceae mentre 17 alle Chlorophyceae. Tra i 238 taxa, 65 sono nuove segnalazioni per la Slovenia, tra le quali 13 Cyanophyceae e 52 Bacillariophyceae. La maggioranza di questi taxa è stato campionata nell'estuario del fiume Dragogna.

**Parole chiave:** alghe, corsi d'acqua, sorgenti, acque salmastre, Slovenia sud-occidentale

INTRODUCTION

The biodiversity of algae in Slovenia is relatively high, as more than 2000 different algae species have been recorded so far (Kosi & Vrhovšek, 1996). The issue of the endangered algal species, threatened by the endangered water ecosystems, has not been clarified as yet due to the lack of investigations. Drastic changes usually occur during the regulation of rivers and streams, when the fundamental ecological conditions are changed (the substrate, water current, light); the consequences are of course reflected in the species' reduced diversity. Similar results can be seen in polluted waters, where the number of species decreases from the sources towards estuaries of the water courses (Vrhovšek et al., 1983). Most of the Slovenian water-streams are already polluted (Vrhovšek et al., 1983, 1994; Krivograd, 1997; Krivograd Klemenčič, 2001; Smolar, 1997). The Dragonja is one of the very few unpolluted Slovenian rivers. The water at its estuary is brackish. The algae occurring in Slovenian brackish waters have not been studied so far. With a view to protect its natural ecosystems with all its constituent parts, including algae, the Dragonja river valley is planned to be given the status of a landscape park. It is necessary to conserve the high diversity of algal species, and the rare species, which cannot be found in other Slovenian rivers due to the Dragonja's very special ecological conditions (flysch landscape, brackish water).

The purpose of this research was to determine the species composition of algal communities in the Dragonja river, from its source to estuary and in its tributary Pinjevec. The only data on the algal species concerned the lower part of the river at Kaštel (in "The research of the quality of surface waters in Slovenia in 1992", Zupan (ed., 1994)), where the sampling site of the Hydro-Meteorological Institute of Slovenia is situated. However, no research has been carried out concerning the algae of the upper part of the Dragonja river and its tributaries. At the sampling site in the Dragonja estuary, the water is brackish. On this occasion let us add that no investigations concerning the brackish waters of Slovenia had been carried out prior to this research.

MATERIALS AND METHODS

Description of sampling sites

The sampling sites are presented in figure 1 and their description given in Table 1. The sampling sites C, D and E are located close to each other. They differ mainly in the speed of the water current. The sampling site B is located in the tributary Pinjevec, just before it joins the Dragonja river.

Tab. 1: Description of sampling sites on Dragonja river and its tributary Pinjevec.

Tab. 1: Opis vzorčnih mest na reki Dragonji in pritoku Pinjevcu.

Sampling sites	Shading of the riverbed	Speed of water-current	Riverbed width (m)	Co-ordinates (after Gauss-Krüger)
A-source	shaded	fast	1	X=5039250 Y=5412000
B-Škrline	partly shaded	changing	15	X=5037125 Y=5402750
C-pool	partly shaded	very slow	10	X=5396825 Y=5034175
D-slow current	shaded	slow	12	X=5034000 Y=5396750
E-strong current	not shaded	fast	7	X=5396825 Y=5034175
F-estuary	not shaded	slow	20	X=5390625 Y=5037250

The samples were collected seasonally during the years 1998, 1999 and 2000 (10. 7. 1998, 18. 7. 1998, 23. 8. 1998, 20. 3. 1999, 29. 7. 1999, 18. 10. 1999, 17. 1. 2000) at all sampling sites. Five periphyton samples were taken at each sampling site for qualitative analysis by scratching the surface of gravel, rocks, macrophytes, wood and other submersed materials (glass and plastic bottles, iron sticks, etc.) The phytoplankton was sampled using the plankton net with mesh size 25 µm at the estuary. The fixation of the samples was done *in situ* with 4% formalin concentration. For diatom determination, samples were pre-treated with saturated HNO<sub>3</sub> (APHA, 1985).

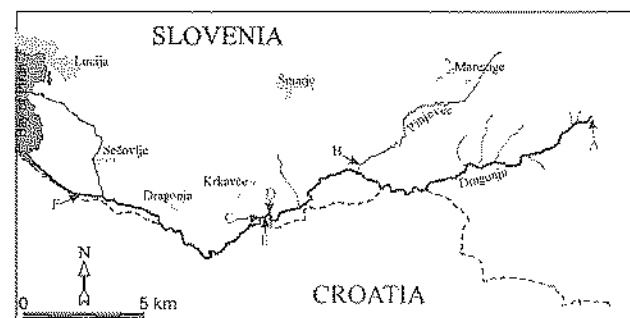

Fig. 1: Map of the river Dragonja and its tributary Pinjevec. Legend: A – source, B – Škrline, C – pool, D – slow current, E – strong current, F – estuary.

Sl. 1: Zemljevid reke Dragonje in pritoka Pinjevca. Legenda: A – izvir, B – Škrline, C – tolmun, D – počasi tekoča, E – brzica, F – izliv.

The algal samples were determined in the laboratory using the light microscope (magnification 1000x). The relative frequency of most common species was evaluated using the numbers from 1 – single, 2 – rare, 3 – common, 4 – frequent and 5 – dominant. The algae were determined using the following identification monographs: Lazar, 1960; Starmach, 1966, 1972; Hindak et al., 1978; Krammer & Lange-Bertalot, 1986, 1988, 1991a, 1991b; Popovsky & Pfiester, 1990; Cvijan & Blaženčič, 1996; Hindak, 1996.

RESULTS AND DISCUSSION

At the five sampling sites on the Dragonja river and at the single site on its tributary Pinjevec, 238 (Tab. 2) algal taxa were established (with their composition presented in figure 2). In view of the number of species, Bacillariophyceae dominated at all sampling sites, followed by Cyanophyceae. A similar situation was recorded in the river Branica flowing on flysch ground (Smolar, 1997). Cyanophyceae were followed by Chlorophyceae at sampling sites A, C, D and F, and by Zygnematophyceae at sampling sites B and E. Zygnematophyceae were not found at sampling site A. *Euglena* sp. was recorded at sampling site D. The species *Peridinium umbonatum* was found at sampling site B, and *Peridinium bipes* at sampling site F. The species *Dinobryon sertularia* was found at sampling sites B, C, D and E. All four species are planktonic. The species *Batrachospermum vagum* was registered at sampling site E, and *Audouinella chalybea* at sampling site F.

The total number of different taxa at sampling site A was 62 (Tab. 2). In all five periphyton samples taken at sampling site A, the following species were found: *Achnanthes minutissima*, *Amphora ovalis*, *Diploneis elliptica*, *D. oblongella*, *Gomphonema angustatum*, *G. angustum* and *Nitzschia linearis* var. *linearis*. The most common species were *Achnanthes minutissima* and *Gomphonema angustatum*. *Achnanthes flexella*, *Cymbella amphicephala* var. *amphicephala*, *Diploneis elliptica*, *Gomphonema angustum* and *Cymbella descripta* are characteristic oligotrophic water species. *Surirella spiralis* is a widespread species, characteristic of the river springs and lakes with limestone ground, containing mid-to high- levels of electrolytes (Krammer & Lange-Bertalot, 1988). The species *Caloneis alpestris*, *Cymbella ehrenbergii*, *C. tumidula* and *Nitzschia angustatula* are widespread and characteristic of karst waters rich in calcium (Krammer & Lange-Bertalot, 1986, 1988).

At sampling site B, the total number of different taxa was 116, at sampling site C 105, at sampling site D 89, and at sampling site E 94 (Tab. 2). Although the water current was quite different between the individual sampling points, the composition of the algal species did not differ much.

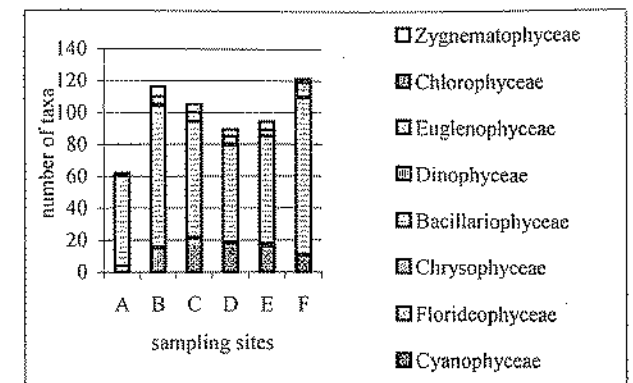

Fig. 2: Algal community structure in the river Dragonja and its tributary Pinjevec during the years 1998, 1999 and 2000 (A – source, B – Škrline, C – pool, D – slow current, E – strong current, F – estuary).

Sl. 2: Sestava alne združbe v reki Dragonji in v pritoku Pinjevcu v letih 1998, 1999 in 2000 (A – izvir, B – Škrline, C – tolmun, D – počasi tekoča, E – brzica, F – izliv).

The changes in biomass along the current occurred mainly because of the differences in the pH values, temperature, water level and the nitrate concentration (Szarek, 1994). Light has a greater impact on the composition of periphyton than the water current, level and nitrate concentration (DeNicola & McIntire, 1990).

In all five periphyton samples taken at sampling sites B, C, D and E, the following species were found: *Achnanthes flexella*, *A. minutissima*, *Anomoeoneis vitrea*, *Cymbella affinis*, *C. cymbiformis*, *C. microcephala*, *Denticula kuetzingii*, *Eunotia arcus*, *Fragilaria biceps* and *Gomphonema angustum*. The most abundant species were *Achnanthes minutissima*, *Cymbella affinis* and *C. microcephala*. The species *Rivularia haematites*, which can be found in stagnant and running waters on limestone (Starmach, 1966), was present at sampling sites B, C and E. On the same substrate, *Amphipleura pellucida*, *Caloneis alpestris*, *Cymbella laevis* and *Tolypothrix cacullata* are also widespread (Starmach, 1966; Krammer & Lange-Bertalot, 1986, 1991a). *Batrachospermum vagum*, a characteristic oligotrophic water species (Hindak et al., 1978), was found at sampling site E during the summer 1998. At sampling sites B, C, D and E, *Dinobryon sertularia* was present, while at sampling site B *Peridinium umbonatum* was established. Both species are characteristic of plankton (Hindak et al., 1978). The presence of plankton species in the rivers depends on the water retention time in stagnant places.

The high species diversity was found at sampling site F – the Dragonja river estuary. The total number of different planktonic and periphyton species was 121 (Tab. 2). By their nature, estuaries are generally eutrophic and dynamic systems. Consequently, the number of species





* <i>Pinnularia subcapitata</i> var. <i>hilseana</i> (Jan.) Muell.	1	1	1	1	
<i>Pinnularia subcapitata</i> var. <i>subcapitata</i> Greg.					1
<i>Pinnularia viridis</i> (Nitzsch) Ehren.		1		1	
* <i>Pleurosigma salinarum</i> Grun.					3
* <i>Pleurosigma strigosum</i> W. Smith					1
<i>Rhoicosphenia abbreviata</i> (Agardh) Lan.-Bert.	1	1	1		1
* <i>Rhopalodia brebissonii</i> Krammer			1		
* <i>Rhopalodia constricta</i> (W. Smith) Kramm.					1
<i>Rhopalodia gibba</i> (Ehren.) O. Muell.	1	1	1	1	
<i>Stauroneis anceps</i> Ehren.		1			
<i>Stauroneis phoenicenteron</i> (Nitzsch) Ehren.		1			
<i>Stauroneis smithii</i> var. <i>smithii</i> Grun.		1			
<i>Surirella angusta</i> Kuetz.		1			
<i>Surirella bifrons</i> Ehren.		1			
<i>Surirella biseriata</i> Breb.					1
* <i>Surirella brebissonii</i> Kramm. & Lan.-Bert.	1				3
* <i>Surirella constricta</i> W. Smith		1			
<i>Surirella spiralis</i> Kuetz.	1				1
<b>DINOPHYTA</b>					
<b>DINOPHYCEAE</b>					
<i>Peridinium bipes</i> Stein					3
<i>Peridinium umbonatum</i> Stein		2			
<b>EUGLENOPHYTA</b>					
<b>EUGLENOPHYCEAE</b>					

<i>Euglena</i> sp.				1		
<b>CHLOROPHYTA</b>						
<b>CHLOROPHYCEAE</b>						
<i>Bulbochaete</i> sp.			1	1		
<i>Cladophora fracta</i> Kuetz.			1		1	
<i>Cladophora</i> sp.				1		
<i>Coelastrum reticulatum</i> (Dang.) Senn.					1	
<i>Enteromorpha</i> sp.					4	
<i>Microspora amoena</i> (Kuetz.) Raben.					1	
<i>Microspora pachyderma</i> (Wille) Lagerh.					1	
<i>Oedogonium</i> sp.	3	1	1	1	1	
<i>Oocystis pusilla</i> Hansg.		1				
<i>Oocystis</i> sp.			1		1	
<i>Pediastrum integrum</i> Naegeli			1			
<i>Scenedesmus brasiliensis</i> Bohl.		1	1			
<i>Scenedesmus serratus</i> (Corda) Bohl.				1		
<i>Trentepohlia aurea</i> (L.) Martius	2	1		1	1	
<i>Ulothrix tenerrima</i> Kuetz.					1	
<i>Ulothrix zonata</i> (Web. & Mohr.) Kuetz.		1				
<i>Uronema confervicolum</i> Lagerh.					1	
<b>ZYGNEMATOPHYCEAE</b>						
<i>Closterium cornu</i> Ehren.			1	1		
<i>Cosmarium ochtodes</i> Nordst.		1	1	1	1	
<i>Cosmarium</i> sp.		1	1		1	
<i>Mougeotia parvula</i> Hassal.		1				
<i>Mougeotia</i> sp.		1	1	1	1	
<i>Spirogyra</i> sp.		1			1	
<i>Zygnema</i> sp.		2	1	3	1	
Total No. of species	62	116	105	89	94	121

\* Algae first recorded in Slovenia

in the flora is variable and sometimes high (Kilham & Mavuti, 1990). However, Remane & Schlieper (1971; in Kies, 1997) discovered just the opposite, that the lowest number of species occurs in brackish waters. The number of species increases with the distance from brackish water towards fresh and salty water. Planktonic algae entering the estuary from upstream reach their upper limit of salt tolerance at approximately 5 ‰, while marine planktonic algae entering the estuary from the sea approach their lower limit in the salinity gradient at about the same point. Fresh-water, brackish and marine algal species were present in the Dragonja river estuary. In the Warri/Forcados estuary in Nigeria, the phytoplankton community was composed of fresh-water, brackish and marine species as well. Fresh water species mainly belonged to Chlorophyceae, Bacillariophyceae and Cyanophyceae, brackish species mainly to Bacillariophyceae, and marine species mainly to Bacillariophyceae and Dinophyceae (Kilham & Mavuti, 1990). Chindah & Pudo (1991) found similar results during their research on algal communities in the estuary of the Bonny river in Nigeria, where Bacillariophyta constituted more than 50% of fresh water and brackish species. Euglenophyceae and Chlorophyceae occurred mainly in those parts of the river estuary, where fresh water was predominant. In the Dragonja river estuary, the marine

and brackish algae were almost exclusively diatoms as well. In the Dragonja estuary, the following marine species were present: *Achnanthes septata*, *Amphora angusta*, *Gyrosigma tenuissimum*, *G. wansbeckii*, *Nitzschia longissima* var. *genuina*, *Pleurosigma strigosum* and *Enteromorpha* sp., and the following brackish species: *Melosira moniliformis*, *Denticula subtilis*, *Navicula duerrenbergiana*, *N. halophila*, *N. incertata*, *N. recens*, *Pleurosigma salinarum*, *Nitzschia compressa* var. *compressa*, *N. granulata*, *N. lorenziana*, *N. levidensis* var. *salinarum*, *N. navicularis*, *N. sigma* and *Rhopaladia constricta*. Very similar brackish and marine species were found in the estuaries of other rivers around the world (Freese, 1952; Hendey, 1958; Wood, 1968; Kilham & Mavuti, 1990). This indicates a cosmopolitan nature of the majority of the above listed algal species. Diatoms predominated in the estuary of Dragonja river, which is similar to the findings by other authors from rivers' estuaries (Chindah & Pudo, 1991; Kies, 1997).

In all five periphyton and phytoplankton samples taken at sampling site F, the following species were present: *Achnanthes septata*, *Cocconeis pediculus*, *Gyrosigma acuminatum*, *Navicula mutica* var. *mutica* and *Nitzschia frustulum*. *Achnanthes septata* and *Nitzschia frustulum* were the most frequent species.

65 algal taxa recorded for the first time in Slovenia

were determined in the Dragonja river and its affluent Pinjevec (Tab. 2). 13 taxa belonged to Cyanophyceae and 52 to Bacillariophyceae. The highest number of the taxa recorded for the first time (38) was determined in the Dragonja river estuary (sampling site F), belonging mainly to the genus *Nitzschia* (9) and *Navicula* (6). Marine and brackish species were predominant, which did not occur at other sampling sites.

### CONCLUSIONS

At the five sampling sites on the Dragonja river (A, C, D, E, F) and at the single site on its tributary Pinjevec (B), the total number of algal taxa was 238. 170 taxa belonged to Bacillariophyceae, 38 to Cyanophyceae, 17 to Chlorophyceae, 7 to Zygnematophyceae, 2 to Florideophyceae, 2 to Dinophyceae, 2 to Chrysophyceae, and 1 to Euglenophyceae. 20 taxa were present at all sampling sites: *Phormidium autumnale*, *P. sp.*, *Achnanthes flex-*

*ella*, *A. minutissima*, *Caloneis alpestris*, *Cymbella affinis*, *C. amphicephala* var. *amphicephala*, *C. microcephala*, *C. silesiaca*, *Diploneis oblongella*, *Eunotia arcus*, *Fragilaria biceps*, *Gomphonema angustatum*, *G. angustum*, *Navicula radiosa*, *N. veneta*, *Nitzschia dissipata*, *N. linearis* var. *linearis*, *N. palea* and *Oedogonium* sp.

Among 238 taxa, 65 were recorded for the very first time in Slovenia. 13 taxa belonged to Cyanophyceae and 52 taxa to Bacillariophyceae. The highest number of the taxa recorded for the first time was determined in the Dragonja estuary. Marine and brackish species, which did not occur at other sampling sites, were predominating. As the algal species composition between sampling sites C, D and E (which differed mainly due to their water currents) did not vary a great deal, it can be concluded that the speed of the water current did not have a significant influence on the composition of the species of algal communities.

### ALGE V REKI DRAGONJI

Aleksandra KRIVOGRAD KLEMENČIČ  
SI-1290 Grosuplje, Čušperk 51

Danijel VRHOVŠEK  
Limnos d.o.o., SI-1000 Ljubljana, Podlimbarskega 31  
E-mail: info@limnos.si

Gorazd KOSI  
Nacionalni inštitut za biologijo, SI-1001 Ljubljana, Večna pot 111

### POVZETEK

V obdobju med letoma 1998 in 2000 smo v različnih letnih časih vzorčevali perifitonske in planktonske alge v reki Dragonji, pritoku Pinjevcu in v brakičnem predelu izliva Dragonje. Namen raziskave je bil ugotoviti vrstno sestavo in relativno abundanco algalnih združb na območju, ki je predvideno za regijski krajinski park. Identificirali smo 238 taksonov alg. Prevladovale so kremenaste alge (170 taksonov), sledile so cianobakterije (38 taksonov) in zelene alge (17 taksonov). Druge skupine alg so bile zastopane le s posameznimi predstavniki. Zasedili smo večje število v Sloveniji prvič opaženih taksonov, ki so vezani predvsem na brakični del izliva Dragonje. Med 65 v Sloveniji prvič opaženimi taksoni je 13 taksonov pripadalo skupini cianobakterij in 52 kremenastim algam. Visoko število teh taksonov je posledica neraziskanosti brakičnih algalnih združb v Sloveniji. Primerjava združb v različnih predelih reke Dragonje (tolmun, brzica, počasi tekoči predel) ne kaže bistvenih razlik v vrstnem sestavu algalnih združb.

**Ključne besede:** alge, reke, izviri, brakične vode, jugozahodna Slovenija

## REFERENCES

- APHA (1985):** Standard methods for the examination of water and wastewater. 16<sup>th</sup> Edition. American Public Health Association, New York, 1268 p.
- Chindah, A. C. & J. K. Pudo (1991):** A preliminary checklist of algae found in plankton of Bonny River in Niger Delta, Nigeria. *Fragm. Florist. Geobot.*, 36(1), 117-126.
- Cvijan, M. & J. Blaženčič (1996):** Cyanophyta. Flora algi Srbije. Naučna knjiga, Beograd.
- DeNicola, D. M. & C. D. McIntire (1990):** Effects of substrate relief on the distribution of periphyton in laboratory streams. II. Interactions with irradiance. *J. Phycol.*, 26, 634-641.
- Freese, L. R. (1952):** Marine diatoms of the Rockport, Texas, Bay Area. *Tex. J. Sci.*, 3, 331-386.
- Hendey, N. I. (1958):** Marine diatoms from some West African Ports. *J. Microsc. Soc.*, 61, 28-85.
- Hindak, F. (1996):** Ključ na určovanie nerozkonarených vlaknitych zelených rias (Ulotrichineae, Ulotrichales, Chlorophyceae). Slovenska botanicka spoločnosť pri SAV, Bratislava.
- Hindak, F., P. Marvan, J. Komarek, K. Rosa, J. Popovsky & O. Lhotsky (1978):** Sladkovodne riasy. Slovenske pedagogicke nakladatelstvo, Bratislava.
- Kies, L. (1997):** Distribution, biomass and production of planktonic and benthic algae in the Elbe estuary. *Limnologica*, 27(1), 55-64.
- Kilham, P. & K. M. Mavuti (1990):** Phytoplankton flora in the Warri/Forcados Estuary of southern Nigeria. *Hydrobiologia*, 208, 101-109.
- Kosi, G. & D. Vrhovšek (1996):** Sladkovodne alge. Narava Slovenije, stanje in perspektive. Zbornik prispevkov o naravni dediščini Slovenije. Društvo ekologov Slovenije, Ljubljana, str. 143-146.
- Krammer, K. & H. Lange-Bertalot (1986):** Bacillariophyceae. 1 Teil: Naviculaceae. Band 2/1. Süßwasserflora von Mitteleuropa. Gustav Fischer Verlag, Stuttgart, New York, 876 pp.
- Krammer, K. & H. Lange-Bertalot (1988):** Bacillariophyceae. 2 Teil: Bacillariaceae, Epithemiaceae, Surirellaceae. Band 2/2. Süßwasserflora von Mitteleuropa. Gustav Fischer Verlag, Stuttgart, New York, 876 pp.
- Krammer, K. & H. Lange-Bertalot (1991a):** Bacillariophyceae. 3 Teil: Centrales, Fragilariaceae, Eunotiaceae. Band 2/3. Süßwasserflora von Mitteleuropa. Gustav Fischer Verlag, Stuttgart, New York, 596 pp.
- Krammer, K. & H. Lange-Bertalot (1991b):** Bacillariophyceae. 4 Teil: Achnanthaceae, Kritische Ergänzungen zu Navicula (Lineolate) und Gomphonema. Band 2/4. Süßwasserflora von Mitteleuropa. Gustav Fischer Verlag, Stuttgart, New York, 576 pp.
- Krivograd, A. (1997):** Prisotnost kremenastih alg v reki Meži. Diplomsko naloga. Univerza v Ljubljani, Biotehniška fakulteta, Ljubljana.
- Krivograd Klemenčič, A. (2001):** Alge posebnih okolij v Sloveniji. Magistrska naloga. Univerza v Ljubljani, Biotehniška fakulteta, Ljubljana.
- Lazar, J. (1960):** Alge Slovenije. Seznam sladkovodnih vrst in ključ za določanje. SAZU, Ljubljana, 279 str.
- Pavlovec, R. (1965):** Sprehod na fliš. *Proteus*, 28(4-5), 97-101.
- Popovsky, J. & L. A. Pfister (1990):** Dinophyceae. Band 6. Süßwasserflora von Mitteleuropa. Gustav Fischer Verlag, Jena, Stuttgart, 272pp.
- Rejic, M. (1988):** Sladkovodni ekosistemi in varstvo voda. Biotehniška fakulteta, VTOZD za gozdarstvo, Ljubljana, 183 str.
- Smolar, N. (1997):** Ocena vpliva odvzema vode iz različnih tipov vodotokov na perifiton v času nizkih pretokov. Magistrska naloga. Univerza v Ljubljani, Biotehniška fakulteta, Ljubljana.
- Starmach, K. (1966):** Cyanophyta-Sinice, Glauciphyta-Glaukofity. Tom 2. Flora sladkovodna polski. Państwowe Wydawnictwo Naukowe, Warszawa.
- Starmach, K. (1972):** Chlorophyta III. Zielenice Nitkovate: Ulotrichales, Ulvales, Prasiolales, Sphaeropleales, Cladophorales, Chaetophorales, Trentepohliales, Siphonales, Dichotomosiphonales. Tom 2. Flora sladkovodna polski. Państwowe Wydawnictwo Naukowe, Warszawa.
- Szarek, E. (1994):** The effect of abiotic factors on chlorophyll a in attached algae and mosses in the Sucha Woda stream (High Tatra Mts, southern Poland). *Acta Hydrobiol.*, 36(3), 309-322.
- Vrhovšek, D., G. Kosi, M. Kralj & M. Bricelj (1983):** Ocena onesnaženosti Save od izvira do Ljubljane s pomočjo perifitona. *Biol. vestn.*, 31(2), 103-118.
- Vrhovšek, D., G. Kosi & N. Smolar (1994):** Limnološka istraživanja Sotle u odnosu na branu u Podčetrtku. *Hrvat. vode*, 2(5), 293-301.
- Wood, E. J. F. (1968):** Studies of phytoplankton ecology in tropical and sub-tropical environments of the Atlantic Ocean, Phytoplankton communities in the Providence Channels and the Tongue of the Ocean. *Bull. Mar. Sci.*, 18, 481-583.
- Zupan, M. (ur.) (1994):** Raziskave kakovosti površinskih voda v Sloveniji v letu 1992. Hidrometeorološki zavod RS, Ljubljana.

original scientific article  
received: 2003-04-09

UDK 556.11.556.36(497.4/5 Istra)

## HYDROCHEMICAL RESEARCH OF THE MLINI SPRINGS, ISTRIA

Janja KOGOVŠEK

Karst Research Institute ZRC SAZU, SI-6230 Postojna, Titov trg 2

E-mail: kogovsek@zrc-sazu.si

Sonja DIKOVIĆ

Institute for Public Health of Istria region, HR-52100 Pula, V Nazora 23

Metka PETRIČ

Karst Research Institute ZRC SAZU, SI-6230 Postojna, Titov trg 2

Josip RUBINIĆ

Faculty of Civil Engineering, University of Rijeka, HR-51000 Rijeka, V.C. Emina 5

Martin KNEZ

Karst Research Institute ZRC SAZU, SI-6230 Postojna, Titov trg 2

Elza HRVOJJIĆ

Croatian Waters, VGO of coastal and Istrian tributaries, HR-51000 Rijeka, Đure Šporera 3

Tadej SLABE

Karst Research Institute ZRC SAZU, SI-6230 Postojna, Titov trg 2

## ABSTRACT

*International co-operation is necessary for an efficient study of karst springs with recharge areas that extend in the territory of more than one country. Such example is the Mlini spring, which was studied within the framework of the Slovene-Croatian programme for scientific co-operation. The spring has been included into the network of the national monitoring of Croatian waters since 1996, and in the planned research detailed measurements of physical-chemical parameters of water were carried out in the chosen water wave formed by intensive precipitation after a prolonged dry period. The obtained results confirm the importance of such additional detailed monitoring that enable us to detect, under adequate hydrological conditions, extreme values of certain parameters of water quality, which could not be detected by regular monitoring.*

**Key words:** Mlini karst spring, monitoring, water quality, Istria, Croatia, Slovenia

## RICERCA IDROCHIMICA DELLA SORGENTE DI MLINI, ISTRIA

## SINTESI

*Per una ricerca efficiente delle caratteristiche delle sorgenti carsiche, l'entroterra delle quali si estende nel territorio di più di una nazione, è necessaria una collaborazione internazionale. Un valido esempio ne è la sorgente di Mlini, che è stata studiata nell'ambito del programma di collaborazione scientifica sloveno-croato. Dal 1996 tale sorgente fa parte del programma nazionale di monitoring della qualità delle acque croate. Nella presente ricerca sono state poste in rilievo le misurazioni dei parametri fisico-chimici dell'acqua nell'ondata provocata da forti piogge, a seguito di un lungo periodo di siccità. I risultati hanno confermato l'importanza di tale monitoring aggiuntivo con il quale è possibile, in condizioni idrologiche adeguate, rilevare valori estremi di alcuni parametri di qualità dell'acqua, che non possono venir misurati durante il monitoring abituale.*

**Parole chiave:** sorgente carsica di Mlini, monitoring, qualità dell'acqua, Istria, Croazia, Slovenia

## INTRODUCTION

The lack of available water resources, along with the increasing need for water, deterioration of its quality and difficulties owing to the exceptionally high waters and erosion, present the principal problems we are confronted with both in Slovene and Croatian territories. For several decades, the researchers from both sides of the border have been quite successful in their attempts to provide solutions. The results of numerous investigations were consequently published, yet the joint projects, which would in an all-embracing way and in multidisciplinary manner deal with the water systems in the border regions, are still lacking. Owing to the fact that the hydrological division of the water basins usually does not match the political boundaries and considering that the recharge areas of water sources may extend into the territory of two or even more countries, the need for an international co-operation is even greater.

The precondition for a successful managing of water resources is good knowledge of hydrological and hydrogeological characteristics of the area; of significant importance, however, are also the data on the changes in the water quality. Our collective work within the Slovene-Croatian Intergovernmental Programme for Cooperation in Science and Technology from 1999 to 2001, »The Hydrological Analysis of Karst Waters«, was for that reason first directed into gathering basic information. Our objective was to assess the hydrological characteristics of water phenomena in the border area of Slovenia and Croatia, to elaborate the hydrological models of individual karst springs' functioning, as well as to analyse their mutual interconnection and optimal functioning.

It needs to be emphasised that a great deal has already been done as far as protection and ecology are concerned. We used the extant hydrological and hydrogeological data for the initial regional quantitative evaluation of the hydrological and hydrogeological parameters of water sources as well as a basis for the planning of our joint research. Within such framework we consequently conducted, in the autumn of 2001, a detailed two-month monitoring of the water quality at the karst spring Mlini, which has been included in the network of national monitoring of the Croatian waters since 1996. We embraced the short period of low water level, which was followed by short yet intensive precipitation forming the water waves, as well as the prolonged period of recession and the establishment of stable conditions. The aim was to compare the results of such detailed observation of water waves under specific hydrological conditions with the data gathered through monitoring with regular sampling at longer intervals. Our supposition was that such additional survey could detect extreme values of certain parameters of water quality, which could not be detected by regular moni-

toring, and in this way provides important additional information.

## Geological composition and hydrogeological characteristics

The Mlini spring is situated in the belt of the reverse fault, by means of which the carbonate massif of Čičarija is thrust onto the flysch strata. This geologically highly interesting structure, which in its geo-tectonic sense belongs to the Adriatic carbonate platform or Adriatic (Herak, 1991) is formed in the NE by the folded Cretaceous carbonate layers, whereas in the SW by the thrust and scale-like composition structure of Paleogene limestones (Pleničar *et al.*, 1969). The basic structure is traversed by Dinaric faults, whose presence has an effect on the specific hydrogeological relations and karst peculiarities.

The imbricate structure of the Čičarija has originated due to pressures from NE towards SW. The same pressures are demonstrated in the thrust of the High Karst (Trnovski gozd, Nanos, Hrušica, Snežniško pogorje) in the territory of Eocene clastic rock of the Vipava and Reka basins. In the High Karst unit, real thrust may be present, whereas in the unit of Čičarija real thrust is predominantly not to be found; what predominates is the forming of scale-like structures. The terrain in this area is built up by well permeable foraminiferal limestones and by less permeable to impermeable flysch layers. These flysch strata, which occur in the synclinal parts of isoclinal and tectonically reduced folds, are relatively close to the surface and have the function of hanging barriers. Such conditions were also indicated by the tracing test results (Fig. 1).

The region of Istria covers the edge of the Adriatic carbonate platform with a special impact on the formation of the karst aquifer and the quality of water within it. On the basis of the hydrogeological research conducted till now, we may estimate that rocks have various permeability, which ranges from high to low, depending on the content of dolomite in the lithological composition of individual stratigraphic sections.

## Hydrological characteristics

The zone of Mlini karst springs is located in the middle part of the surface stream of Bračana, which is the most important tributary of the river Mirna (Fig. 1). It comprises one permanent spring, which bursts out at an altitude of 90 m, and two springs at an altitude of 110 m, which are active only during high waters. During more intensive precipitation some water outflows in them also from the Jama pod Krogom Cave, which intersects the Slovene-Croatian border. In the cave, there is a permanent water stream that during higher water levels flows over the entrance at an altitude of 144-m a.s.l.

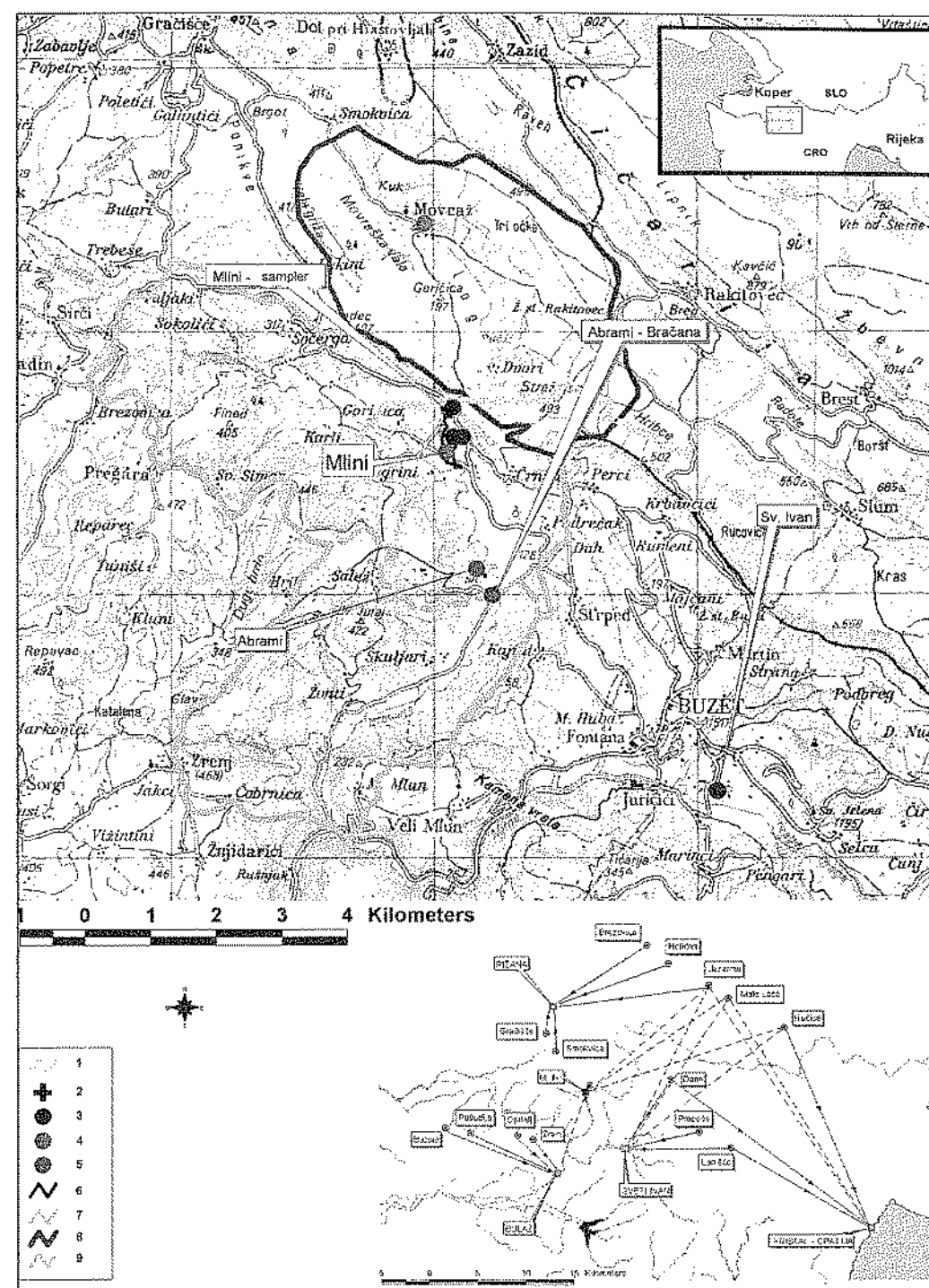

Fig. 1: Location map and the presentation of results of tracing tests in the wider area of Mlini springs: 1 – state border; 2 – automatic water sampler; 3 – spring; 4 – precipitation station; 5 – hydrological station; 6 – hydrographic network; 7 – surface watershed of the Bračana; 8 – hydrogeological watershed of Mlini spring; 9 – surface watershed of the Bračana – Abrami station.

Sl. 1: Pregledna karta in prikaz rezultatov sledenja na širšem območju izvirov Mlini: 1 – državna meja; 2 – avtomatski zajemalnik; 3 – izvir; 4 – padavinska postaja; 5 – hidrološka postaja; 6 – hidrografska mreža; 7 – površinska razvodnica Bračane; 8 – hidrogeološka razvodnica izvira Mlini; 9 – površinska razvodnica Bračane – postaja Abrami.



Tab. 1: Characteristic hydrological parameters of the Bračana surface stream at Abrami station and of the Mlini springs.

Tab. 1: Karakteristični hidrološki parametri površinskega toka Bračane na postaji Abrami in izvirov Mlini.

Param.	Month												annual mean
	I	II	III	IV	V	VI	VII	VIII	IX	X	XI	XII	
Hydrological station ABRAMI – BRAČANA (discharges in m <sup>3</sup> /s)													
Period of measurement: 1985-1998													
Q <sub>mean</sub>	0.92	0.72	0.62	0.66	0.46	0.42	0.14	0.09	0.21	0.78	0.98	0.85	0.57
S	0.77	0.61	0.54	0.32	0.50	0.54	0.12	0.07	0.24	1.02	0.69	0.73	0.18
Cv	0.84	0.85	0.87	0.48	1.07	1.27	0.91	0.80	1.13	1.31	0.70	0.85	0.32
Q <sub>in-min</sub>	0.04	0.03	0.06	0.21	0.11	0.04	0.02	0.01	0.01	0.03	0.05	0.09	0.37
Q <sub>in-max</sub>	2.52	2.30	1.74	1.34	2.03	2.11	0.45	0.24	0.77	2.97	2.42	2.18	1.01
Q <sub>min</sub>	0.04	0.02	0.01	0.06	0.02	0.02	0.002	0.002	0.01	0.01	0.02	0.04	0.002
Q <sub>max</sub>	21.80	15.30	17.60	15.30	20.00	29.70	7.98	5.50	16.30	49.90	25.60	25.90	49.90
Hydrological station ABRAMI – BRAČANA (discharges in m <sup>3</sup> /s)													
Period of measurement: hydrological year 1986/1987													
Q <sub>mean</sub>	0.06	0.17	0.40	0.76	0.99	0.25	0.50	0.79	0.25	0.08	0.23	0.07	0.38
Q <sub>min</sub>	0.03	0.03	0.05	0.06	0.16	0.11	0.19	0.13	0.16	0.05	0.05	0.03	0.03
Q <sub>max</sub>	0.41	6.20	9.30	8.45	6.48	2.32	3.54	7.47	0.99	0.16	4.00	0.81	9.30
Hydrological station MLINI SPRING (discharges in m <sup>3</sup> /s)													
Period of measurement: hydrological year 1986/1987													
Q <sub>mean</sub>	0.02	0.14	0.31	0.26	0.65	0.12	0.25	0.45	0.03	0.02	0.16	0.02	0.20
Q <sub>min</sub>	0.02	0.03	0.03	0.02	0.13	0.02	0.07	0.03	0.02	0.02	0.02	0.02	0.02
Q <sub>max</sub>	0.12	2.80	3.29	1.49	3.29	1.49	2.57	2.57	0.04	0.02	2.34	0.02	3.29

Tab. 2: Mean monthly and annual precipitation at the Abrami and Movraž stations.

Tab. 2: Srednje mesečne in letne padavine na postajah Abrami in Movraž.

Period	Month												annual mean
	I	II	III	IV	V	VI	VII	VIII	IX	X	XI	XII	
Precipitation station: ABRAMI (precipitation in mm)													
1961-98	88	71	83	91	96	106	82	101	115	119	129	93	1174
1986/87	59	61	74	97	108	24	70	137	95	61	89	62	937
Precipitation station: MOVRAŽ (precipitation in mm)													
1961-90	117	143	110	108	85	105	106	100	108	87	115	116	1300
1986/87	64	67	84	101	113	48	62	129	82	84	128	133	1095

(Habič et al., 1983). The minimal flow rate of springs is 0.015 m<sup>3</sup>/s, yet with their average common discharge of 0.2 m<sup>3</sup>/s they contribute, in place where they flow into it, around 50% of the Bračana's entire water volume. The spring is captured for the water supply of the Mlini village.

The data on discharges of the Mlini springs are rare and related to the short-term periods of measurements or temporary observations. According to the available data, the first monitoring of the spring results are linked to the period 1971/72, when the flow rate ranged between 0.032 m<sup>3</sup>/s and 2.2 m<sup>3</sup>/s. For the annual monitoring with the staff gauge in the hydrological year 1986/87 the

measured mean annual discharge amounts to 0.199 m<sup>3</sup>/s, with the fluctuation of daily discharges between 0.019 m<sup>3</sup>/s and 3.293 m<sup>3</sup>/s. During the temporary observation in the 1994/95 interval, the discharge ranged between 0.013 m<sup>3</sup>/s and 3.244 m<sup>3</sup>/s. In the period from 11 September to 12 December 2001, however, the discharges measured within the framework of the joint Slovene-Croatian project ranged between 0.020 m<sup>3</sup>/s and 2.199 m<sup>3</sup>/s.

The closest permanent limnigraph station on the Bračana surface stream is Abrami station, towards which 19.4 km<sup>2</sup> of the flysch recharge area and a part of the karst aquifer, which is discharged through the spring

Mlini, is being drained. If Bračana's mean discharge of 0.570 m<sup>3</sup>/s is taken into account for the 1985-1998 period, the average annual precipitation volume measured at the precipitation station Movraž and Abrami, which is equal to 1165 mm, and the mean annual evapotranspiration for the region of Istria, which is 725 mm (Pristov, 1998), we may estimate the total extent of the Bračana's recharge area at approximately 41 km<sup>2</sup>, which would signify that the share of the karst recharge area amounts to around 21.6 km<sup>2</sup>.

The comparison of the measured discharges of the Bračana stream and Mlini springs is demonstrated in Table 1, whereas in Table 2 we inserted the mean monthly and annual precipitation measured at the precipitation stations Abrami and Movraž.

Both hydrological and precipitation data indicate that the hydrological year 1986/87 was relatively dry. For the hydrological station Abrami, the yearly runoff coefficient of 0.29 was calculated for the year 1986/87. The monthly runoff coefficients range between 0.09 (September and October) and 0.67 (January). With regard to the hydrological conditions, these values prove to be in accordance with the regionally determined values of the runoff coefficient (Žugaj, 1995).

In the period from 1 September to 12 November 2001, the gauging station Mlini was temporarily restored and we were able to measure the total discharges of permanent and intermittent springs. For this period, figure 2 displays mean daily discharges of the Mlini spring and of the Bračana surface stream at the Abrami station as well as mean daily precipitation at Movraž and Abrami stations.

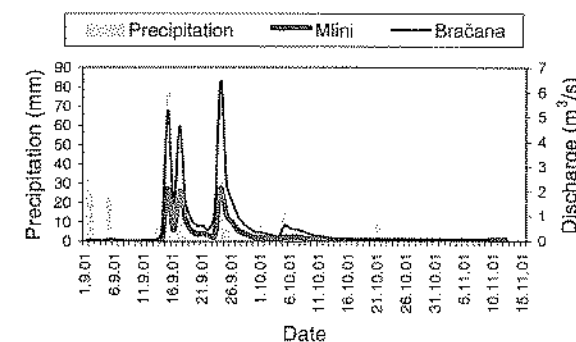

Fig. 2: Daily discharges and precipitation in the September - November 2001 period.

Sl. 2: Dnevni pretoki in padavine v obdobju september - november 2001.

The previous period of summer 2001 was exceptionally dry and for that reason the first rainfall in the beginning of September, which exceeded 20 mm, was not reflected in the increase of the discharge. Due to the interception on the vegetation cover, enlarged evapotranspiration and the filling in of soil moisture deficit the ef-

fective infiltration proved to be practically negligible. Only more intensive precipitation on 15 September (68.4 mm at Abrami and 84.6 mm at Movraž station) resulted in a significant increase of discharges. Within the next days the rainy period continued and in September of 2001 the rainfall quantity amounted to a double average quantity common for this month. Characteristically higher were also the average discharges. Precipitation in October and November were, however, once again below the average values.

The analysis of interrelations between daily precipitation at Abrami and Movraž stations indicated a high correlation (R<sup>2</sup>=0.96):

$$H_{MOVRAZ} = 1.173 \cdot H_{ABRAMI} - 0.45 \text{ (mm)}$$

We also compared daily values of discharges at the Mlini springs and Bračana stream. Subsequent to the two-month observations discharges of the former ranged between 0.020 m<sup>3</sup>/s and 2.199 m<sup>3</sup>/s having an average value of 0.243 m<sup>3</sup>/s, whereas the latter ranged between 0.032 m<sup>3</sup>/s and 6.44 m<sup>3</sup>/s with an average of 0.530 m<sup>3</sup>/s. The share of water from the Mlini springs in the Bračana surface stream at Abrami station was thus around 44%. Within the analysed scope of discharges, the level of correlation proved to be very high (R<sup>2</sup>=0.968), whereas the determined linear dependence does not apply to the discharges larger than approximately 2 m<sup>3</sup>/s in case of Mlini and 4-5 m<sup>3</sup>/s in case of Bračana, since due to the restrained outflow of the underground waters the discharge of Mlini springs does not follow the rise in the surface Bračana stream.

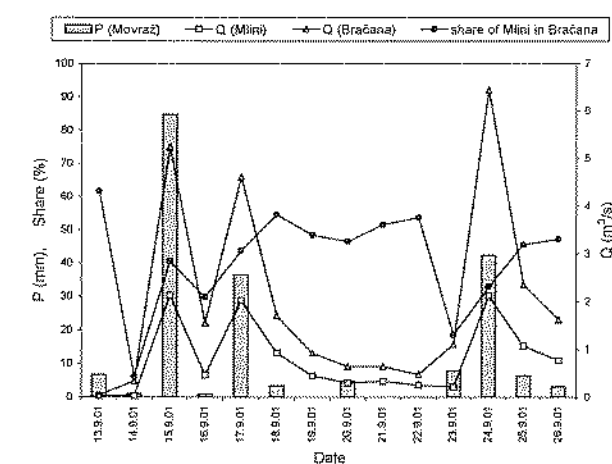

Fig. 3: The share of Mlini springs in the total discharge of the Bračana stream.

Sl. 3: Delež izvirov Mlini v skupnem pretoku Bračane.

A comparison of shares of discharge of the Mlini springs in the total discharge of the Bračana at the Abrami station is also interesting. In figure 3, these

shares are represented during both most intensive precipitation events. The considerable decrease in the share of the Mlini spring just before the rise of discharges indicates that the surface Bračana stream with its flysch recharge area reacts characteristically faster to precipitation than the Mlini karst spring. We may also find out that within a longer period of dry weather the Mlini spring represents the principal source of water in the Bračana stream (around 50%).

We may thus conclude that the selected two-month period of monitoring physical and chemical characteristics of the Mlini spring proves to be of hydrological interest primarily due to the possibility of observing the

reactions of the spring and the surface stream to the first precipitation after the prolonged period of dry weather.

#### MATERIAL AND METHODS

At the Mlini karst spring we also conducted, between 11 September and 14 November 2001, a two-month detailed monitoring of the composition of its water. Thus we covered a short period of low waters that was followed by a brief yet intensive precipitation forming water waves, as well as longer period of recession and a longer period of reestablishment of stable conditions.

**Tab. 3: The applied methods of analyses are ISO methods (10253:1994; 7888:1985; 5813:1983; 5815:1989; 9963-1:1994) (APHA, 1995), and DIN 38409 H18 method.**

**Tab. 3: Uporabljene ISO metode (10253:1994; 7888:1985; 5813:1983; 5815:1989; 9963-1:1994) (APHA, 1995) in DIN 38409 H18 metoda.**

Indicator	Method	Detection limit
temperature	*St.Meth. 2550 B.	
pH	ISO 10253:1994.	
Conductivity – SEC	ISO 7888:1985	1 $\mu\text{S}/\text{cm}$
turbidity	turbidimetric	5 $\text{mgSiO}_2/\text{l}$
dissolved oxygen	ISO 5813:1983	0.01 $\text{mgO}_2/\text{l}$
BOD <sub>5</sub>	ISO 5815:1989	0.01 $\text{mgO}_2/\text{l}$
COD – permanganate	method according to Kubel Tiemann	0.01 $\text{mgO}_2/\text{l}$
alkalinity	ISO 9963-1:1994	0.002 $\text{mmol CaCO}_3/\text{l}$
chlorides	St. Meth. 4500-Cl B. argentometric	0.1 $\text{mg}/\text{l}$
sulphates	St. Meth. 400-SO <sub>4</sub> E. turbidimetric	1 $\text{mg}/\text{l}$
hardness – total	St. Meth. 2340 C. complexometric (EDTA)	0.002 $\text{mmol CaCO}_3/\text{l}$
total solids dried at 105 °C	St. Meth. 2540 B. gravimetric	0.001 $\text{mg}/\text{l}$
total suspended solids dried at 105 °C	St. Meth. 2540 D. filtration through GF 45 $\mu\text{m}$ , gravimetric	0.001 $\text{mg}/\text{l}$
ammonia	spectrophotometric with fenolate hypochloritome	0.001 $\text{mgN}/\text{l}$
nitrites	St. Meth. 44500-NO <sub>2</sub> B. spectrophotometric with $\alpha$ -naftilamine and sulfinic acid	0.001 $\text{mgN}/\text{l}$
nitrates	St. Meth. 4500-NO <sub>3</sub> B.	0.01 $\text{mgN}/\text{l}$
organic nitrogen	St. Meth. 4500-N <sub>org</sub> B. digering in the acid media, spectrophotometrical as ammonia	0.001 $\text{mgN}/\text{l}$
ortho-phosphates	St. Meth. 4500-P E. spectrophotometrical with ammonia-molibdate and ascorbic acid	0.005 $\text{mgP}/\text{l}$
total phosphorus	digering, followed by a procedure as with ortho-phosphates	0.005 $\text{mgP}/\text{l}$
oil and grease, mineral oils	DIN 38409 H18	0.002 $\text{mg}/\text{l}$
Mn, Cu, Cr, Pb	AAS – flameless technique (graphite)	1 $\mu\text{g}/\text{l}$
Cd	AAS – flameless technique (graphite)	0.1 $\mu\text{g}/\text{l}$
K, Na, Ca, Mg	AAS – flame technique	0.1 $\text{mg}/\text{l}$
Zn	AAS – flame technique	5 $\mu\text{g}/\text{l}$
Fe	AAS – flame technique	10 $\mu\text{g}/\text{l}$
TC, FC, FS	MF technique, selective bases, number/100ml	
aerobic mesophile bacteria N/37	nutrient agar 37 °C, number /m	

The measurements of discharge, temperature, pH and the specific electrical conductivity (SEC) were carried out by means of YSI 600 probe at 5-minute intervals and were then saved in a datalogger with ISCO 6700 portable sampler. At the same time and within the set interval (every 6 hours at the beginning and three times per week later on), water samples were also collected. Parallel with the sampling we manually measured temperature of the spring water by means of a quicksilver thermometer and also manually, gathered some samples to determine the quantity of dissolved oxygen, oil and grease, mineral oils and heavy metals (cadmium, copper, zinc, iron, manganese, total amount of chromium and lead). In the laboratory, the samples taken by automatic sampler were analysed on pH, SEC, turbidity, presence of suspended solids, total solids, alkalinity, total hardness, chlorides, sulphates and indicators of nutrient substances: ammonia, nitrites, nitrates and organic nitrogen. We also determined the phosphates, total phosphorus, sodium, potassium, calcium, magnesium, COD-permanganate and BOD<sub>5</sub>, UV absorption and bacteriological analyses (total coliform bacteria, faecal coliform bacteria, faecal streptococci and the number of aerobic mesophile bacteria at 37 °C – N/37). The analyses were conducted in the Institute for Public Health of the Istrian region in Pula, whereas the methods used in determination are to be found in Table 3.

#### RESULTS AND DISCUSSION

##### Temperature, pH, specific electrical conductivity – SEC and total suspended solids

Measurements of temperature, SEC and pH by means of YSI 600 probe were until 11 October unfortunately absent for an unknown reason. In the period until 23 October, we occasionally detected some difficulties in measuring SEC and pH, most probably due to the fallen leaves carried by water and accumulated around the probe. The temperature measurements were performed with no problems at all. The entire period of monitoring proved to be very stable, i.e. from 12.7 to 12.8 °C, which was also confirmed by the manual measurements with quicksilver thermometer during every manual sampling.

By means of YSI 600 probe, we measured the pH values within the interval from 7.0 to 7.4 and the average value 7.2. The pH measurements of the collected samples performed in the laboratory demonstrated higher values ranging from 7.2 to 8.0 and the average value of 7.7, which is probably a consequence of the heating and airing of samples in the automatic sampler, since they remained closed in it for up to 5 days, and due to the transport to the laboratory.

The measurements of SEC by means of YSI 600 probe after 11 October, provided to eliminate greater

variations due to the given difficulties, displayed an even increase of values between 478 and 510  $\mu\text{S}/\text{cm}$  with an average value of 489  $\mu\text{S}/\text{cm}$ . In the period from 18 October until 6 November 2001, these values matched very well with the SEC measurements conducted in the laboratory, which yielded slightly lower values (Fig. 4). However, we have no reasonable explanation for the measurement differences occurring after 6 November.

At the time of the first two water waves, the SEC decreased (laboratory measurement), as actually expected. From 14 to 19 September 2001, the SEC decreased from 436  $\mu\text{S}/\text{cm}$  to 409  $\mu\text{S}/\text{cm}$ , and then rose to 461  $\mu\text{S}/\text{cm}$ . Simultaneously, with the increase of discharge and decrease of SEC, the turbidity markedly increased as well, whereas the quantity of total suspended solids increased to a lesser degree (Fig. 4), which indicates a greater transfer of small, solid particles and the lower quantity of dissolved substances due to the inflow of less mineralised water. This was additionally corroborated by the measurements of alkalinity, calcium and total hardness. During the next water wave on 24 and 25 September, however, we detected no decrease in SEC and no decrease in calcium and alkalinity. This perhaps reflected the inflow of water from different parts of the aquifer.

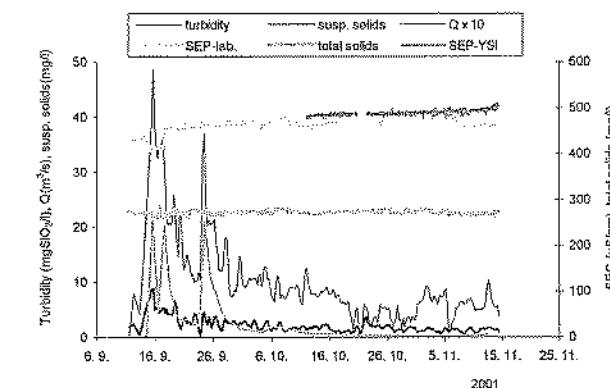

**Fig. 4: Mlini spring: measurements of turbidity, total suspended solids, total solids and conductivity – SEC in autumn 2001 (5-term smoothing used for the measuring of turbidity and suspended matter).**

**Sl. 4: Izvir Mlini: meritve motnosti, suspendiranih snovi, suhega ostanka in specifične električne prevodnosti – SEP jeseni 2001 (meritve motnosti in suspendiranih snovi so glajene 5 v 1).**

The water present in the Mlini springs contains mostly calcium and hydrogen-carbonates. During the time of measurements it contained from 4 to 8.5% magnesium and from 2 to 7% of non-carbonates. The alkalinity ranged from 284 to 317  $\text{mg HCO}_3/\text{l}$ , the total hardness from 242 to 272  $\text{mg CaCO}_3/\text{l}$ , the share of calcium from 91 to 103  $\text{mg Ca}^{2+}/\text{l}$ . The quantity of potas-

sium fluctuated between 0.5 and 1.1 mg K<sup>+</sup>/l, whereas the share of sodium oscillated more markedly between 1.9 and 4.8 mg Na<sup>+</sup>/l. During the rise of the discharge at the time of water waves the quantity of sodium perceptibly decreased.

#### Dissolved oxygen, COD-Mn, BOD<sub>5</sub> and UV absorption

The water in the Mlini springs is well saturated with oxygen, i.e. from 87 to 104%. COD measurements showed values from 0.6 to 1.9 mg O<sub>2</sub>/l, and BOD<sub>5</sub> measurements from 0.3 to 1.1 mg O<sub>2</sub>/l (Fig. 5). The dilution effect in the period of the first two water waves resulted in a decrease of the physical-chemical parameters, and a simultaneous increase of the transfer of tiny, solid particles, also signified a slightly enlarged input of organic oxidizable substances. The largest increase of COD was registered during the water waves, although we detected a similar oscillation of this parameter later on as well.

Some organic substances, which usually emerge in the water, e.g. lignin, tannin, humic acids and various aromatic compounds, possess the manifested absorption within the UV area of  $\lambda=254$  nm. The measured value of absorption denotes presence of these organic compounds and not an individual component. The increased values of organic burdening were detected after the rainfall and during the increased discharge of the spring (Fig. 5).

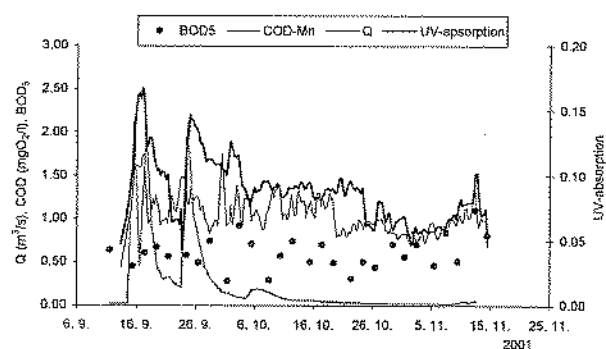

Fig. 5: Mlini spring: measurements of BOD<sub>5</sub>, COD-Mn and UV-absorption conditioned by the water discharge in autumn 2001 (5-term smoothing used for values of UV absorption and KPK).

Sl. 5: Izvir Mlini: nihanje BPK<sub>5</sub>, KPK-Mn in UV-absorbicije v odvisnosti od pretoka jeseni 2001 (vrednosti UV absorbicije in KPK so glajene 5 v 1).

#### Nutrient substances

Nutrient substances represent the compounds of nitrogen and phosphorus. Various nitrogen compounds, which are apart of the nitrogen cycle or the compounds

of differently valenced nitrogen, are created in nature by means of microorganisms. This cycle is one of the most important dynamic processes in nature and represents, together with the string of other bio-chemical reactions, the basis of bio-disintegration, which is taking place in nature. What occurs at this point is the process of exchange of nitrogen between the atmosphere, organic substance and inorganic compounds. The presence of ammonia and nitrites in water indicates organic pollution, since ammonia is generated through the microbiological disintegration of amino groups out of the proteins.

The analyses carried out at the Mlini springs indicated the quantity of the ammonia (present as NH<sub>4</sub><sup>+</sup>) ranging between <0.001 and 0.080 mg N/l, whereas the concentration of nitrites was constantly below 0.001 mg N/l. The share of the organically bound nitrogen amounted up to 0.677 mg N/l. Nitrate is the final inorganic product of the mineralisation of the organic matter. During the water wave, we registered a noticeable decrease of nitrates, which we ascribe to the diluting process. The quantity of nitrates in the observed period oscillated between 0.10 and 1.48 mg N/l. At the same time there were no visible changes of other N-components, which signifies that at the time of the greater discharge the increased transfer of these components occurred.

The analyses of ortho-phosphates yielded values between 0.007 and 0.046 mg P/l, and in one case even 0.079 mg P/l. Some greater changes were detected in the total phosphorus, whereby during the water waves we registered some moderate oscillations, whereas larger increases were noticed only 25 to 30 days after the precipitation. Subsequent to this followed the period of the lowest values ranging from 0.020 to 0.060 mg P/l (Fig. 6).

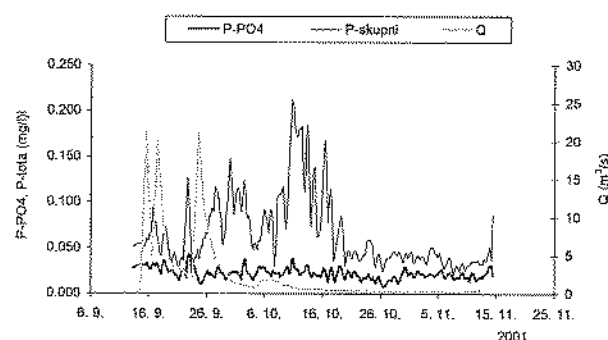

Fig. 6: Mlini spring: measurements of phosphates and total phosphorus (5-term smoothing used).

Sl. 6: Izvir Mlini: nihanje fosfatov in celokupnega fosforja ob nihanjih pretoka jeseni 2001 (vrednosti so glajene 5 v 1).

#### Organic compounds

In the water from the Mlini springs we also determined the quantity of total lipophilic substances and mineral oils. During the water waves after the precipitation there also occurred, in addition to the increased inflow of the suspended matter and organic pollution, an increase of the quantity of oil and grease or lipophilic substances, which were extracted in the strong organic solvent.

Subsequent to the first less intensive precipitation on 12 and 13 September, when the discharge of the Mlini spring did not yet significantly increase, besides the increase of the turbidity and oil and grease, a brief upsurge in the concentration of mineral oils (0.01 mg/l) also occurred. In the stable hydrological conditions, prior to the rainfall, their concentration was below 0.006 mg/l. During the water waves up to the middle of October their concentration, parallel to the decreasing discharge, oscillated around 0.0045 mg/l. In the stable conditions, during the further slow decrease of discharge below 0.6 m<sup>3</sup>/s, a renewed rise of the concentration of mineral oils up to 0.0147 mg/l occurred. This pattern of the occurrence of mineral oils was recorded in all springs in the region of Istria: an increase in the share of mineral oils immediately after the precipitation due to the rise in the presence of suspended substances and the later increase of them in stabilised conditions, in transparent and clear samples. Here we are probably witnessing the initial washing out during the minimal increase of discharge and the later outflow of lighter oils, which were washed by rainfall through the vadose zone and along the connected channels reached the spring only during the lowering of the water level in the underground.

The quantity of oil and grease most markedly rose at the time of the first water wave (0.054 mg/l). During the second water wave it was below 0.012 mg/l, while later on, in the recession period, it again ranged from 0.013 to 0.031 mg/l.

#### Heavy metals

The water samples were analysed with regard to the concentrations of cadmium, copper, zinc, iron, manganese, total chromium and lead. The total content of metals was also determined both of the part dissolved in water and the part bound to the suspended particles. Cadmium concentration in the spring water is below the detection limit of 0.1 µg/l. Other metals occur occasionally in measurable concentrations. At the time of the first water wave the amount of metals increased.

Copper rose from the initial value of <1.0 µg/l to 31.7 µg/l, whereas later on it oscillated only up to the maximum concentration of 6.6 µg/l. The quantity of chromium in the first water wave increased to 11.8 µg/l

and in the ensuing twenty days fell back to <0.1 µg/l. The concentration of lead increased in similar way from <0.1 µg/l to 6.3 µg/l, then started to decline and fluctuate around the value of 1 µg/l, and fell under 0.1 µg/l only in the stabilised hydrological conditions in November. Manganese, too, rose significantly during the first water wave from its initial value of 0.1 to 105 µg/l, yet later its concentration rapidly declined and subsequently oscillated around the concentration of 2 µg/l.

The quantity of iron deviates from the pattern of the already mentioned metals. From the initial concentration of 26.3 µg/l it increased during the first water wave to 105 µg/l; during the second wave it increased to 126 µg/l and during the third wave to 146 µg/l. There followed a decline to the value of 24.4 µg/l reached by the end of October, with a subsequent upsurge to 179 µg/l after a minor discharge increase. The quantity of zinc slightly increased during the water waves, yet it reached its highest values in the recession period (Fig. 7).

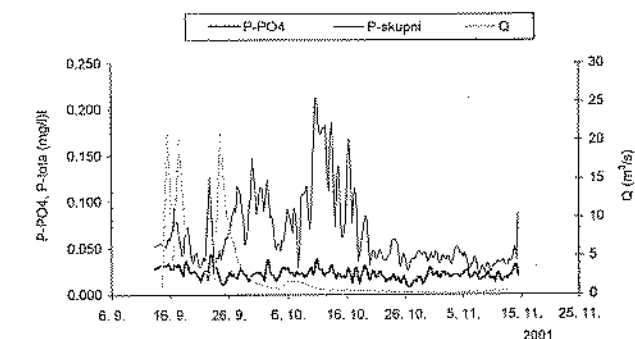

Fig. 7: Mlini spring: measurements of zinc, lead and iron in autumn 2001.

Sl. 7: Izvir Mlini: vsebnost cinka, svinca in železa jeseni 2001.

#### Bacteriological indicators

In the collected samples we analysed the following: total coliform bacteria (TC), faecal coliform bacteria (FC), faecal streptococci (FS), and aerobic mesophile bacteria (N/37) (Figs. 8 and 9).

Larger inflow of water from the surface layers during the water wave caused an increased microbiological pollution which, however, quite rapidly declined. In the second half of October and in November the bacteriological burdening of water was relatively low, yet it still did not fulfil the criteria required for the potable water.

The process of changes in the quantity of overall coliform bacteria (TC) and faecal coliform bacteria (FC) proved to be very similar (Fig. 8), except that the latter reached lower values. There were two maximums, the first on 13 September in the morning, when the discharge was only beginning to grow, and the other simultaneously with the highest discharge of the first



wave. In the period of the second water wave, the TC and FC gradually decreased and reached the lowest values during the third water wave. More markedly they increased on 7 October during the decrease of the discharge after its slight increase.

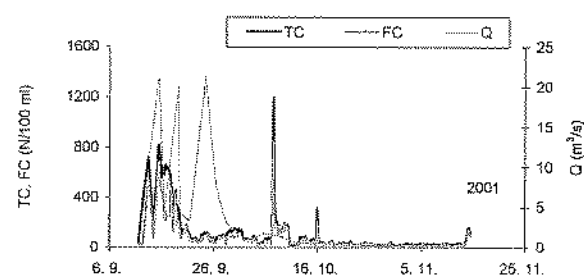

Fig. 8: Mlini spring: total coliform bacteria (TC) and faecal coliform bacteria (FC) in autumn 2001.

Sl. 8: Izvir Mlini: skupne koliformne bakterije (TC) in fekalne koliformne bakterije (FC) jeseni 2001.

Aerobic mesophile bacteria (N/37) increased slightly later than TC and FC, i.e. during the increase and decrease of the discharge in the 1<sup>st</sup> and 2<sup>nd</sup> water wave, as if a dilution effect occurred at the peak of the water wave. The quantity of faecal streptococci (FS) rose later than already mentioned bacteria and reached their maximal value with a slight delay after the peak of the first water wave; later, however, they gradually declined, yet they reached their initial value prior to the precipitation only in the middle of October, whereas later on their concentration fell even lower. The renewed rises were registered by the end of our observations, when the discharge increased once again (Fig. 9).

#### Comparison of the results with the measurements carried out within the framework of the national monitoring of the Republic of Croatia

The Mlini spring has been included in the Croatian national monitoring network since 1996. Since then the monitoring has changed a great deal, both in the extent of parameters and in the frequency of measurements and analyses. As far as the springs on the Istrian peninsula are concerned, there has been an increase in the number of parameters by means of which the samples of water were analysed, whereas the number of sample collection has fallen.

If we compare the minimal, maximal and mean values for the year 2000, when most sample collections were carried out (12), with the frequent sampling conducted from September to November 2001, we can notice that the majority of the parameter values from the detailed observations of the autumn 2001 actually fall into the range of measured values in the year 2000. Larger values were detected for SEC, alkalinity, total

hardness, calcium and magnesium, which is a reflection of the increased dissolving of carbonate rocks in the autumn period. We also established an increased turbidity and larger shares of suspended solids, manganese, total chromium and especially an increased presence of all kinds of bacteria, as well as an occasional rise in the organic nitrogen, total phosphorus and phosphates. The majority of the increases were related to the rise in the discharge of the Mlini springs after precipitation, washing out of the aquifer and the enlarged transport power of water.

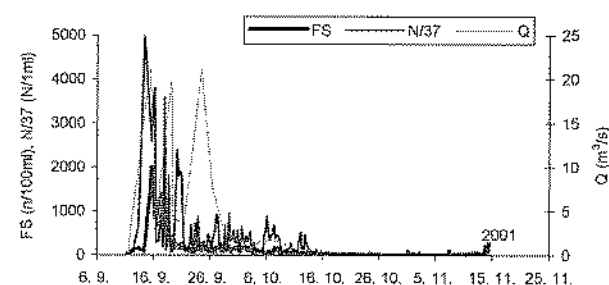

Fig. 9: Mlini spring: faecal streptococci (FS) and aerobic mesophile bacteria (N/37) in autumn 2001.

Sl. 9: Izvir Mlini: fekalni streptokoki (FS) in aerobne mezofilne bakterije (N/37) jeseni 2001.

These findings indicate a great importance of detailed observations of the springs, particularly during the periods of intensive precipitation when greater variations also occur, which cannot be perceived by regular monitoring with less frequent measurements.

#### CONCLUSIONS

The selected two-month period of observation of physical-chemical characteristics of the Mlini spring is interesting especially because of the possibility of observing the reactions of the spring to the precipitation after prolonged periods of draught. Hydrologically interesting is the response of the spring to the first rainfall at the beginning of September, which during two days exceeded 20 mm. The discharge did not change visibly, since the effective infiltration was due to the interception on the vegetation cover, increased evapotranspiration and the filling in of the soil moisture deficit practically negligible. Only more intensive rainfall on September 15 resulted in a significant and rapid increase of the discharge, when we also monitored the changes in the composition of water.

The discharge increase of the Mlini spring subsequent to the precipitation signifies on the one hand dilution, which was reflected in low concentrations of dissolved substances (SEC, alkalinity, total hardness, cal-

cium and magnesium), while on the other hand the precipitation caused intensive washing of the aquifer and also brought into the spring, during the increased discharge and along with enlarged transport power, greater quantities of suspended solids, increased organic pollutants (UV absorption, COD) and particularly bacteriological pollution as well as larger quantities of heavy metals (especially manganese and total chromium) bound to suspended particles. The quantity of mineral oils, which during the initial increased turbidity rose for a brief period, as well as the increase in the quantity of oil and grease during the first increase of the discharge and later in the stabilised hydrological conditions parallel to the slowly decreasing discharge, probably reflects a given manner of the transport of substances, which do not mix with water. This phenomenon was detected in karst springs throughout Istria (Diković & Stipić, 2000; Diković, 2001, 2002).

On the basis of the conducted research we may conclude that in order to obtain more accurate picture of the functioning, sampling would be required at intervals of at least 12 hours, which is due to the rapid changes, especially in the initial part of the water waves, whereas the measurements of temperature, SEC and pH by probes (automatic recording of data by means of dataloggers) should be carried out even more frequently. The described detailed manner of spring monitoring significantly supplements the usual karst spring monitoring, which was in the case of Mlini springs conducted at two-month intervals. The temporal planning of more accurate detailed measurements is subject to hydrological conditions. The performed measurements have shown that the greatest changes in water composition and quality occur during the increase of the spring's discharge after more extensive precipitation, particularly subsequent to a longer period of dry weather.

#### HIDROKEMIČNE RAZISKAVE IZVIRA MLINI, ISTRA

Janja KOGOVIŠEK

Inštitut za raziskovanje krasi ZRC SAZU, SI-6230 Postojna, Titov trg 2

E-mail: kogovsek@zrc-sazu.si

Sonja DIKOVIĆ

Zavod za javno zdravstvo Istarske županije, HR-52100 Pula, V. Nazora 23

Metka PETRIČ

Inštitut za raziskovanje krasi ZRC SAZU, SI-6230 Postojna, Titov trg 2

Josip RUBINIĆ

Građevinski fakultet Sveučilišta u Rijeci, HR-51000 Rijeka, V.C. Emina 5

Martin KNEZ

Inštitut za raziskovanje krasi ZRC SAZU, SI-6230 Postojna, Titov trg 2

Elza HRVOJIĆ

Hrvatske vode, VGO, HR-51000 Rijeka, Đure Šporera 3

Tadej SLABE

Inštitut za raziskovanje krasi ZRC SAZU, SI-6230 Postojna, Titov trg 2

POVZETEK

V okviru slovensko-hrvaškega medvladnega programa sodelovanja v znanosti in tehnologiji smo jeseni 2001 dva meseca podrobno spremljali kakovost vode na kraškem izviru Mlini. Izvir, ki je zajet za vodooskrbo vasi Mlini, leži v srednjem delu površinskega toka Bračane, ki je najpomembnejši desni pritok Mirne. Že od leta 1996 je vključen v nacionalni monitoring kakovosti hrvaških voda, v načrtovani raziskavi pa smo posebno pozornost posvetili detajlnemu spremljanju spreminjanja fizikalno-kemijskih parametrov vode v vodnem valu v ekstremnih hidroloških razmerah. Zajeli smo kratko obdobje nizkega vodostaja, ki so mu sledile kratkotrajne, a intenzivne padavine in oblikovale vodne valove ter daljše obdobje iztekanja in vzpostavljanja stabilnih razmer.

Po padavinah povečanje pretoka Mlinov pomeni po eni strani razredčenje, ki se je pokazalo v nižjih koncentracijah raztopljenih snovi (SEP, alkaliteti, celokupni trdoti, kalciju in magneziju). Na drugi strani pa padavine intenzivno spirajo zaledje izvira in ob povečanem pretoku z večjo transportno močjo prenašajo v izvir tudi večje količine

suspendiranih snovi, povečano organsko onesnaženje (UV absorpcija, KPK) in predvsem bakteriološko onesnaženje ter večje količine težkih kovin (predvsem mangan in celokupni krom), vezanih na suspendirane snovi. Vsebnost mineralnih olj, ki se je kratkotrajno zvišala ob začetni povečani motnosti, ter povečanje vsebnosti skupnih maščob ob prvem naraščanju pretoka ter kasneje v stabilnih hidroloških razmerah ob počasi upadajočem pretoku verjetno odseva način prenosa snovi, ki se z vodo ne mešajo. Ta pojav beležijo v kraških izviroh celotne Istre.

Na osnovi opravljenih raziskav lahko zaključimo, da je zaradi hitrih sprememb, predvsem v začetnem delu vodnih valov, za pridobitev podrobnejše slike dogajanja potrebno vzorčevanje vsaj v intervalu 12 ur, medtem ko je priporočljivo meritve temperature, SEP in pH s sondami (avtomatsko beleženje podatkov z dataloggerji) opravljati pogosteje. Opisani podrobnejši način opazovanja izvirov je pomembna dopolnitev običajnega monitoringa kraškega izvira, ki se v primeru izvira Mlini opravlja v časovnem intervalu dveh mesecev. Časovno načrtovanje podrobnejšega merjenja je vezano na hidrološke razmere. Opravljene meritve so pokazale, da prihaja do največjih sprememb sestave oz. kakovosti vode ob povečanju pretoka izvira po izdatnejših padavinah, predvsem po koncu daljših sušnih obdobj.

**Ključne besede:** kraški izvir Mlini, monitoring, kakovost vode, Istra, Hrvaška, Slovenija

## REFERENCES

**APHA (1995):** Standard Methods for the Examination of Water and Wastewater. 19<sup>th</sup> Edition. Eaton, A. D., L. S. Clesceri & A. E. Greenberg (eds.). American Public Health Association, Washington DC.

**Diković, S. & Ž. Stipić (2000):** Program ispitivanja kakvoće voda u Istarskoj županiji u 1999. g. Elaborat arhive Zavoda za javno zdravstvo Istarske županije i Hrvatske vode.

**Diković, S. (2001):** Godišnji izveštaj za 2000 g. o praćenju kakvoće voda na državnim vodama na području Istarske županije. Elaborat arhive Zavoda za javno zdravstvo Istarske županije i Hrvatske vode.

**Diković, S. (2002):** Kakvoća voda na državnim vodama u 2001. g. na području Istarske županije. Elaborat arhive Zavoda za javno zdravstvo Istarske županije i Hrvatske vode.

**Habič, P., R. Gospodarič, A. Mihevc & F. Šušteršič (1983):** Movraška in Smokavska vala ter Jama pod Krogom. Acta carsologica, 11, 77-97.

**Herak, M. (1991):** Dinaridi: mobilistički osvrt na genezu i strukturu. Acta geol. (Prirodoslovna istraživanja. 63), 21(2), 35-117.

**Pleničar, M., A. Polšak & D. Šikić (1969):** Osnovna geološka karta SFRJ, list Trst, 1:100.000. Zvezni geološki zavod, Beograd.

**Pristov, J. (1998):** Vodna bilanca. V: Kolbezen, M (ur.): Površinski vodotoki in vodna bilanca Slovenije. MOP-Hidrometeorološki zavod Republike Slovenije, Ljubljana, str. 41-98.

**Žugaj, R. (1995):** Regionalna hidrološka analiza u kršu Hrvatske. Hrvatsko hidrološko društvo, Zagreb.

original scientific article  
received: 2003-07-21

UDK 556.55.04(234.323.6)

## RELATIONS BETWEEN AIR TEMPERATURE, PRECIPITATION AND SURFACE AND VERTICAL WATER TEMPERATURE VARIATIONS IN THE THREE KRIŠKO LAKES (JULIAN ALPS, NW SLOVENIA) IN JULY 2002

Gregor MURI

National Institute of Biology, SI-1000 Ljubljana, Večna pot 111

Saša ERŽEN

Student at the Department of Geography, Faculty of Arts, SI-1000 Ljubljana, Aškerčeva 2

## ABSTRACT

Daily air temperatures and amount of precipitation were measured at Pogačnikov dom at Kriški podi in July 2002. Surface lake water temperatures in the three Kriško lakes, i.e. Zgornje Kriško lake, Srednje Kriško lake and Spodnje Kriško lake, were also recorded. Vertical lake water temperatures were additionally measured in Srednje Kriško lake and the heat content was calculated. Remarkable fluctuations of surface lake water temperatures were observed. Changes in the mean air temperature and amount of precipitation correlated well with variations of the surface lake water temperature. In the deeper water layers, a correlation between the lake water temperature and changes of meteorological parameters was lower. Lower lake water temperature variations were also observed in this lake section. Nevertheless, the thickness of the epilimnion and the metalimnion varied during the study. The former increased, while the latter shrank, as the days got warmer. The calculation of heat content showed that around 65% of the total heat content in Srednje Kriško lake was stored in the upper two meters of the lake.

**Key words:** air temperature, water temperature, heat content, alpine lakes

## RELAZIONI TRA TEMPERATURA DELL'ARIA, PRECIPITAZIONI E VARIAZIONI DELLA TEMPERATURA SUPERFICIALE E VERTICALE DELL'ACQUA NEI TRE LAGHI DI KRIŠKO (ALPI GIULIE, SLOVENIA NORD-OCCIDENTALE) NEL LUGLIO 2002

## SINTESI

La temperatura diurna dell'aria e l'ammontare delle precipitazioni sono stati misurati al Rifugio di Pogačnik, località Kriški podi, nel luglio 2002. È stata inoltre registrata la temperatura superficiale dell'acqua nei laghi Zgornje Kriško jezero, Srednje Kriško jezero e Spodnje Kriško jezero. La temperatura verticale dell'acqua è stata misurata solo nel Srednje Kriško jezero. Sono state osservate notevoli fluttuazioni nella temperatura superficiale dell'acqua del lago. Le variazioni della temperatura media dell'aria e dell'ammontare delle precipitazioni sono state correlate con le variazioni della temperatura dell'acqua superficiale. Negli strati più profondi la correlazione tra la temperatura dell'acqua e le variazioni dei parametri meteorologici è risultata minore. In questo strato sono state rilevate anche le variazioni della temperatura dell'acqua. Gli spessori di epilimnion e metalimnion sono tuttavia cambiati nel corso dello studio. Il primo è aumentato, mentre il secondo si è ridotto con il riscaldarsi dei giorni.

**Parole chiave:** temperatura dell'aria, temperatura dell'acqua, contenuto in calore, laghi

## INTRODUCTION

Water temperature is an important parameter in lakes (Wetzel, 1983). It has a strong impact on the biological activity and growth of aquatic organisms, since most aquatic organisms are cold-blooded. Water temperature is also important due to its influence on water chemistry. Some chemical parameters in turn affect biological activity and aquatic life. The rates of chemical reactions, solubility and toxicity of compounds are all temperature dependent (Stumm & Morgan, 1996). An example of the effects of water temperature on water chemistry is its impact on the oxygen concentration. The oxygen concentration in warmer lake water is lower than in cooler lake water. Thus, warmer lake water may be saturated with oxygen but it would still not contain enough oxygen for the survival of aquatic life. Since climatic changes have been observed in the last decades, modelling of water temperature and dissolved oxygen concentration in lakes has received considerable attention over the years in order to assess impact of these two parameters on lakes and their aquatic life in the future (e.g., Antonopoulos & Gianniou, 2003; Ottosson & Abrahamsson, 1998).

Seasonal water temperature changes in lakes are mostly correlated with seasonal changes in air temperature. Parameters, such as lake volume, transparency and hydrology all affect water temperature (Wetzel, 1983). Solar radiation is absorbed directly by lake water, while the heat in lake is distributed by mixing of lake water. However, upper water layers are heated more rapidly than the rest of the lake water. As the surface water is warmed, it becomes less dense and the relative thermal resistance of mixing increases. As a consequence, a thermal stratification of lakes is generally observed in the summer. The upper water layers, called the epilimnion, are warm and less dense, while the deeper water layers, called the hypolimnion, remain cold and dense. In the metalimnion, a remarkable drop of water temperature is observed. The epilimnion and the hypolimnion do not mix with each other. Thus, physical, chemical and biological characteristics are usually significantly different in the two layers. In spring and autumn, the water column is mixed completely and spring and autumn turnovers occur.

Mountain lakes are specific ecosystems in many aspects. They are remote and not exposed to direct anthropogenic impact. On the other hand, they are small and consequently sensitive ecosystems. Thus, they have been often used as valuable sensors of environmental change (Wathne & Rosseland, 2000). Mountain lakes are covered with ice for a long period of the year. In the Julian Alps, ice cover periods as short as five and as long as nine months per year were observed (Brancelj, 2002). The duration of ice cover period significantly affects physical and, in turn, chemical and biological conditions in lakes. Also, it has been demonstrated that even

small average air temperature changes of 1 to 2°C can lead to evident changes in water chemistry, hydrology and biota (Koinig *et al.*, 1998; Skjelkvale & Wright, 1998). Similar conclusions were found in the study on Slovenian mountain lakes (Muri & Brancelj, 2003).

The aim of the present work was to study surface and vertical lake water temperature variations in three remote high altitude Slovenian alpine lakes. Three Kriško lakes were selected as study sites, since they are located at different elevation, but close to each other and are similar in size. At the lodge Pogačnikov dom at Kriški podi, the air temperature was measured three times per day, the minimum and maximum temperature was also obtained and precipitation was collected after each rain event in July 2002. Surface water temperatures in Zgornje, and Spodnje Kriško lakes were simultaneously recorded four times per day. In addition, the vertical profile of water temperature in Srednje Kriško lake was measured twice per week and the heat content was calculated. Finally, all parameters were correlated and relation between the air temperature, precipitation amount, lake water temperature and heat content was studied. Since water temperature is an important physical parameter in lakes, this study contributes to a better understanding of physical and subsequently chemical and biological processes and their changes in mountain lakes.

## MATERIAL AND METHODS

## Sampling sites

Zgornje, Srednje and Spodnje Kriško lakes are situated in the Julian Alps, NW Slovenia. These mountain lakes are of glacial origin and surrounded by steep slopes. They all lie above the tree level and are relatively small and shallow. Their topographical characteristics are summarized in Table 1, while geographical position is shown in Fig. 1. On average, these lakes are covered with ice for at least seven and even nine months per year (Brancelj, 2002). The mean annual precipitation rate is high, averaging to 3.200 mm per year (Kastelec, 1999). The lakes have no permanent surface inflows. The main bedrock is limestone. Since the lakes are situated in the protected area of Triglav National Park, direct anthropogenic impact on the lakes is scarce and the lakes are still relatively pristine.

Tab. 1: Topografske značilnosti merilnih mest (podatki iz Brancelj, 2002).

Tab. 1: Topographical characteristics of sampling stations (from Brancelj, 2002).

Sampling site	Altitude [m]	Surface area [ha]	Max. depth [m]
Zgornje Kriško jezero	2150	0.66	9
Srednje Kriško jezero	1950	0.29	9
Spodnje Kriško jezero	1880	0.86	9

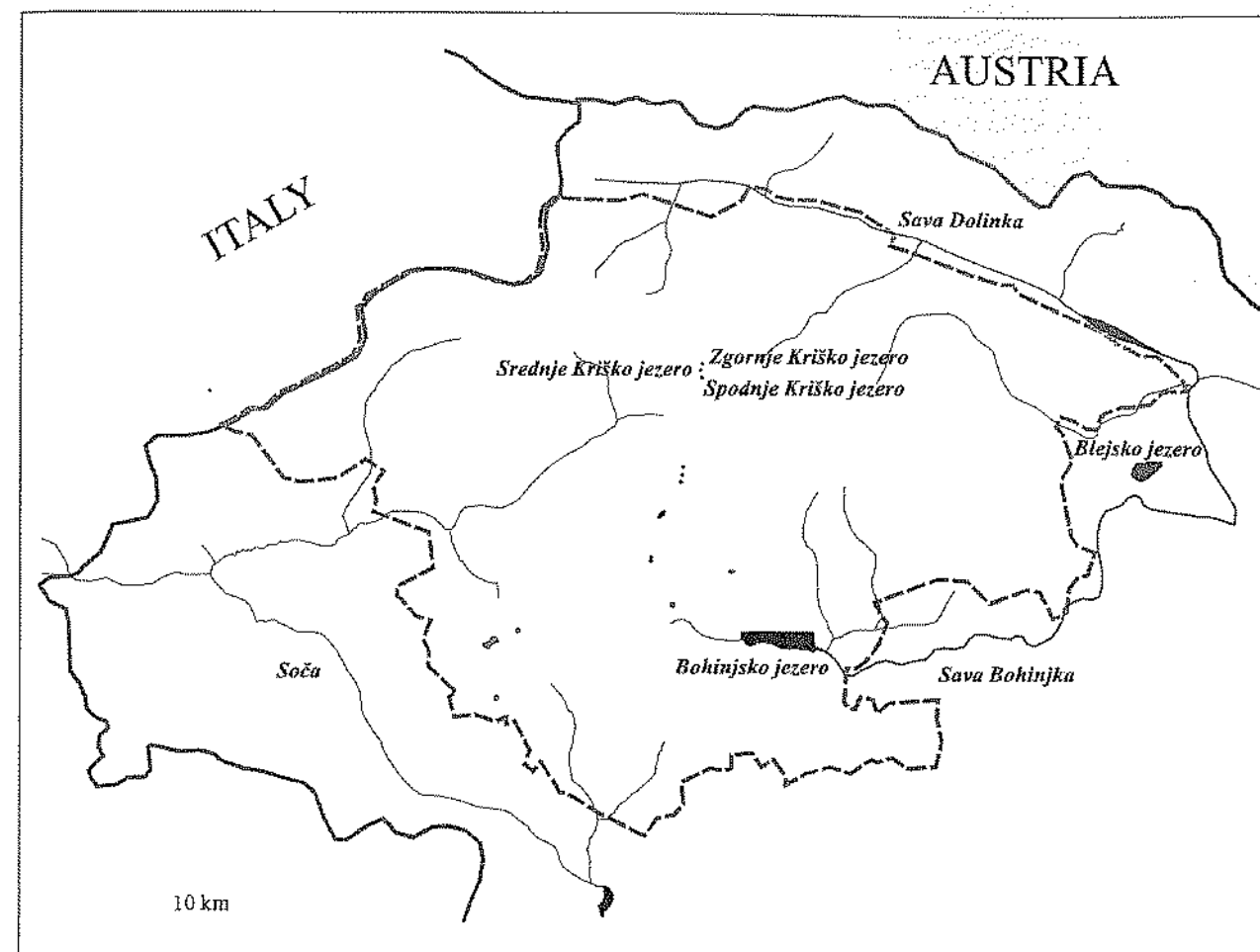

Fig. 1: Geographical position of Zgornje, Srednje and Spodnje Kriško lakes.  
Sl. 1: Geografska lega Zgornjega, Srednjega in Spodnjega Kriškega jezera.

## Measurements of air and water temperature and precipitation

The air temperature was measured with a glass thermometer at the lodge Pogačnikov dom at Kriški podi, 2050 m, which is located 100 m (in altitude) above Srednje Kriško lake. Air temperatures were recorded three times per day, i.e. at 7 AM, 2 PM and 9 PM. A minimum and maximum thermometer was also used to obtain the minimum and maximum air temperatures of the day. All thermometers were placed two meters above the ground in a shaded area protected from strong winds but open to air circulation.

Precipitation was also collected at Pogačnikov dom at Kriški podi using a metal canister. Amount of precipitation was measured and emptied manually just after each rain event.

Minithermistors (MINILOG-TR, Vemco) were used to monitor surface lake water temperatures. They were actually positioned approximately 0.25 m below the

water surface in order to avoid the highest water temperature fluctuations that occurred on the surface water layer due to changes in intensity of solar radiation. The range of minithermistors was from -4 to 20°C, with a resolution of 0.1°C. The surface water temperature was recorded four times per day. On comparing surface water temperatures in the lakes, the late afternoon values were taken, when the daily highest values were observed. Vertical lake water temperatures were measured using a Pt 1000 probe. Its resolution was 0.1°C in the range from -30 to 100°C. The temperature profile was measured in 1 m intervals above the deepest part of the lake.

## RESULTS AND DISCUSSION

## Air temperature and amount of precipitation

Air temperatures at the lodge Pogačnikov dom at Kriški podi varied considerably in July 2002 (Fig. 2).



Maximum air temperatures ranged from 8.0 to 20.0°C, while minimum air temperatures ranged from 3.5 to 11.0°C. The highest minimum and maximum air temperatures were observed at the beginning of the month, on July 11, reaching 11.0 and 20.0°C, respectively. The lowest minimum and maximum air temperatures were also observed on the same day, on July 26. They dropped to 3.5 and 8.0°C, respectively. Variations of the minimum air temperature were not substantial. The minimum air temperature averaged 8.2°C. Higher values

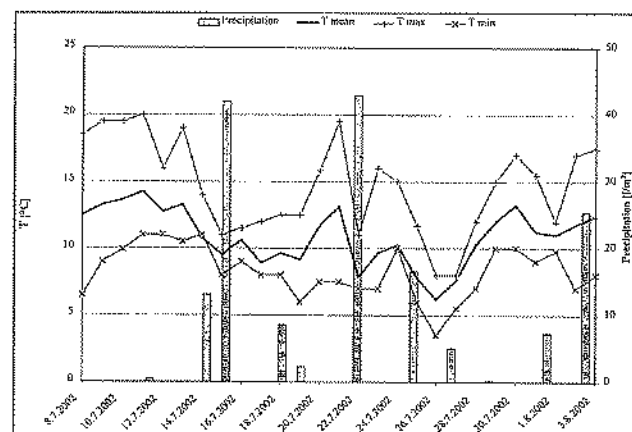

Fig. 2: Variations of the daily mean (T mean), minimum (T min) and maximum (T max) air temperatures and amount of precipitation at the lodge Pogačnikov dom at Kriški podi in July 2002.

Sl. 2: Spreminjanje povprečne dnevne (T mean), minimalne (T min) in maksimalne (T max) temperature zraka in količina padavin pri Pogačnikovem domu na Kriških podih v juliju 2002.

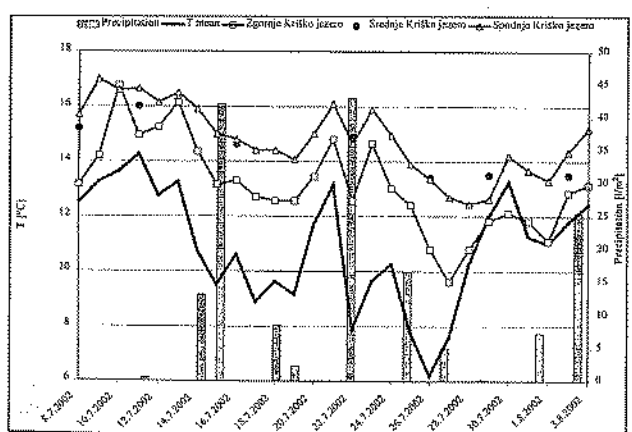

Fig. 3: Relations between air temperatures, amount of precipitation and surface water temperatures in Zgornje, Srednje and Spodnje Kriško lakes in July 2002.

Sl. 3: Odnos med temperaturo zraka, količino padavin in površinsko temperaturo vode v Zgornjem, Srednjem in Spodnjem Kriškem jezeru julija 2002.

were observed in the second week of July and in early August. Nevertheless, much lower values were observed around July 26. In contrast, variations of the maximum air temperature were more pronounced (Fig. 2). The warmest weather was observed in the second week of July. During this period, the maximum air temperatures ranged around 19.0°C and evidently exceeded the average maximum air temperature, which amounted to 14.7°C. In the rest of the month, the maximum air temperatures were mostly below the average value.

There were eleven days with rain events (Fig. 2). In total, 164 mm of rain fell. The highest amount of precipitation was observed on July 22, when 43 mm of rain was recorded. Substantial rain events were also observed on July 15 and August 3, with 42 and 25 mm of rain, respectively. During the rest of rain events, less than 17 mm of rain was observed.

It can be concluded from Fig. 2 that precipitation had a strong impact on air temperatures. During all days, when precipitation events were observed, the mean, minimum and maximum air temperatures decreased remarkably.

#### Surface lake water temperatures

Variations of surface lake water temperatures in Zgornje Kriško lake, Srednje Kriško lake and Spodnje Kriško jezero are presented on Fig. 3. Surface water temperatures in Zgornje Kriško lake and Spodnje Kriško lake closely followed each other. Nevertheless, higher values were observed in the latter lake. Surface water temperatures in Spodnje Kriško lake varied from 12.5 to 17.0°C. In Zgornje Kriško lake, they ranged from 9.6 to 16.8°C. In both lakes, the highest surface water temperatures were observed in the second week of July. During the rest of the month, they were mostly lower and averaged to 14.2°C in Spodnje Kriško lake and to 12.5°C in Zgornje Kriško lake. The surface water temperature in Srednje Kriško lake was mostly intermediate between the values observed in the other two lakes (Fig. 3).

Remarkable surface water temperature variations were observed and correlated well with the mean air temperature and intensity, as well as frequency of precipitation events (Fig. 3). Between July 8 and July 11, the weather was fine with clear sky. The mean air temperature increased and surface water temperatures in all lakes also increased. Between July 12 and July 19, the weather was mostly cloudy. The mean air temperature dropped considerably, by 5°C. Surface water temperatures also decreased remarkably. Frequent rain events were additionally observed during this period. After rain events, a drop in surface water temperature was even more pronounced. Although the weather was mostly fine between July 20 and July 25, surface water temperature dropped by 2.2 and 1.4°C in Zgornje and

Spodnje Kriško lakes, respectively, when the mean air temperature dropped by 5.2°C on a single rainy day (July 22, 43 l m<sup>-2</sup> of rain). However, on the next day, when the weather improved, almost the same surface water temperatures were observed than before that cold day. A period of very cold and rainy weather followed between July 25 and July 27. The mean air temperature dropped down to 6.2°C and surface water temperatures also decreased steeply. The surface water temperature in Spodnje Kriško lake was 1.8°C lower than the average value, while in Zgornje Kriško lake the difference was even higher and amounted to 2.9°C. In the late July and early August, the mean air temperatures were again higher and so were surface water temperatures.

It was also noted that surface water temperatures decreased with increasing altitude of the lakes. In Zgornje Kriško lake they were generally from 1.5 to 2.0°C lower than in Spodnje Kriško lake. Surface water temperatures obtained in Srednje Kriško lake were generally higher than in Zgornje Kriško lake but lower than in Spodnje Kriško lake and were closer to the values obtained in the latter lake since their altitudes are more comparable (Table 1).

In Zgornje and Spodnje Kriško lakes, surface water

temperatures were recorded four times per day. Thus, surface water temperature variations in different periods of the day were also observed. Surface water temperatures in the two lakes were normally the highest in the late afternoon but varied as much as 4°C during sunny days with clear sky. In contrast, they varied for less than 0.5°C during cold and cloudy days. Most of the solar radiation that affects the lake water temperature is absorbed in the surface water layers (Wetzel, 1983). Remarkable variations of surface water temperatures during the day are thus expected.

#### Vertical lake water temperatures and heat content

Vertical water temperature profiles were measured only in Srednje Kriško lake. Water temperature decreased with depth (Fig. 4). It was quite uniform in the upper water layers (the epilimnion). The highest values were observed at the water surface and ranged from 13.4 to 16.0°C. Between depths of approximately two and five meters, water temperature dropped remarkably, by about 5°C (the metalimnion). In the deeper water layers (the hypolimnion), only slight variations of water temperature were observed. It varied from 5.7 to 7.7°C.

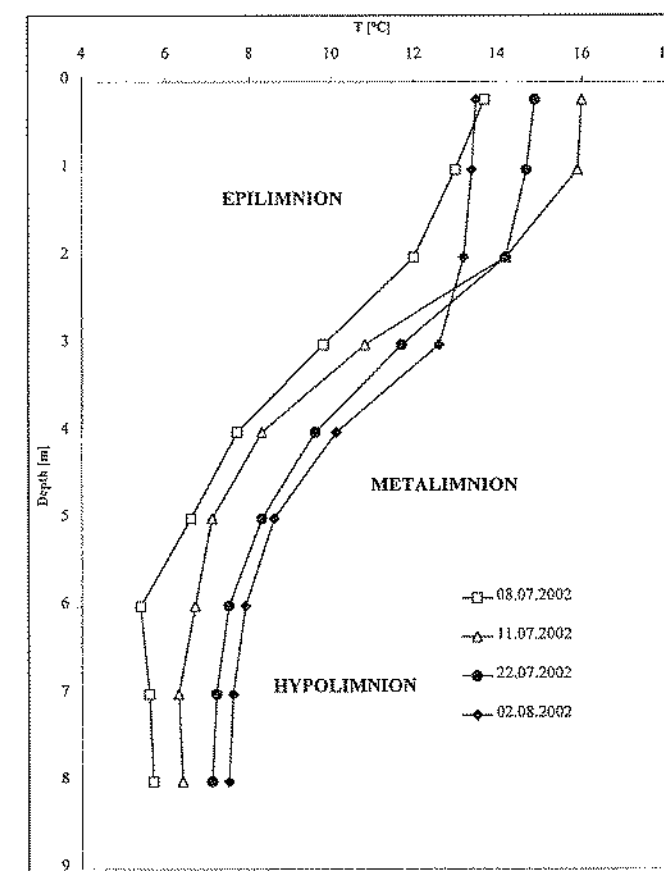

Fig. 4: Vertical profiles of water temperatures in Srednje Kriško lake in July 2002.  
Sl. 4: Globinski profili temperature vode v Srednjem Kriškem jezeru julija 2002.

Vertical water temperatures in Srednje Kriško lake were also compared with changes in the mean air temperature and amount of precipitation. A higher correlation between meteorological parameters and water temperatures was observed in the epilimnion than in the hypolimnion. Vertical water temperature profiles (Fig. 4) showed that deeper water layers were much less susceptible to outside conditions, such as precipitation events and intensity of solar radiation than surface waters. Lower variations of the water temperature were also observed in this lake section. Deeper water layers have a certain heat capacity and cannot be so quickly warmed up or cooled down than the upper water layers (Wetzel, 1983). Additionally, epilimnion and hypolimnion waters do not mix due to differences in water density, thus further retarding the heat transfer through the water column.

The thickness of the epilimnion, the metalimnion and the hypolimnion also changed with time (Fig. 4). On July 8, the epilimnion was only two meters thick, whereas one month later, on August 2, it amounted to three meters. The thickness of the metalimnion and the temperature drop in it also changed. The metalimnion was thick as much as four meters on July 8, but shrank to two meters on August 2. Also, the water temperature dropped by nearly 7°C on the former day but only by 4.5°C on the later day. The thickness of the hypolimnion remained nearly the same throughout the time of experiment, amounting to around two meters and starting at a depth of approximately six meters. These water layers are thus relatively independent from outside conditions.

The vertical distribution of heat content was also calculated for Srednje Kriško lake (Fig. 5). Meter by meter distribution of the heat content was initially calculated, according to the formula  $m C_p \Delta T$ .  $m$  is the mass of the layer (calculated as  $\rho S h$ ;  $\rho$  is the density of water ( $1 \text{ kg dm}^{-3}$ ),  $S$  the area of the layer and  $h$  the height (1m).  $C_p$  is specific heat of water ( $4.2 \text{ J g}^{-1} \text{ K}^{-1}$ ), while  $\Delta T$  delineates the temperature difference of the layer relative to 0°C. The total heat content was finally calculated as a sum of the heat stored in all layers of the lake. It was normalized to the surface area of the lake. The lake was subsequently divided into three different sections. The upper section extended from 0 to 2 meters, the second one from 2 to 5 meters, and the bottom one from 5 to 8 meters. These lake sections roughly represented epilimnetic, metalimnetic and hypolimnetic waters, respectively. During July 2002, the total heat content of the lake averaged to  $138 \text{ MJ m}^{-2}$ . This value is comparable to the values that were determined in other lakes of similar size and depth (e.g. Ambrosetti & Barbanti, 2001). The average contribution of the epilimnetic waters was  $90 \text{ MJ m}^{-2}$ , while metalimnetic and hypolimnetic waters contributed 43 and 6  $\text{MJ m}^{-2}$  to the total heat content, respectively (Fig. 5). The calculation hence showed that the upper section of the lake (0-2 m)

comprised from 62 to 68% of the total heat content. Most of the heat in the lake was thus stored in the epilimnion. In addition, it was found that the relative contribution of this layer to the total heat content decreased during the study, since the lake warmed up (Figs. 4 and 5). The 2-5 m section contributed from 29 to 33% to the total heat content. Its contribution in contrast increased slightly during the study. The bottom section (5-8 m) contributed only 4% to the total heat content and its contribution remained very uniform during the study. Only a minor part of the heat was thus stored in the hypolimnion.

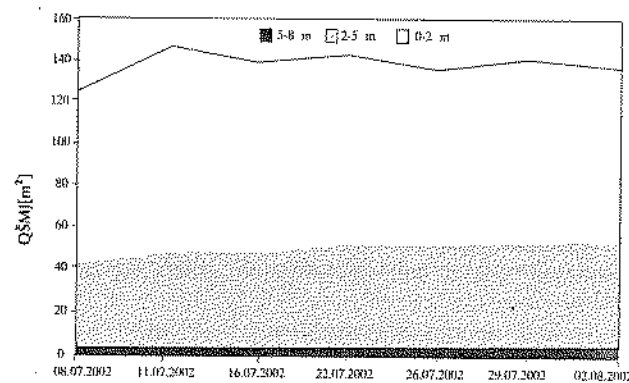

Fig. 5: Vertical distribution of heat content in Srednje Kriško lake in July 2002.

Sl. 5: Vertikalna porazdelitev toplote v Srednjem Kriškem jezeru julija 2002.

#### Effects of lake water temperature on lake condition

The lakes, selected in this study, are relatively small lake systems. Thus, a fast response between the air temperatures, amount of precipitation and surface water temperature was observed. Surface water temperatures in the lakes changed daily. In contrast, a longer time period (of weeks) was needed for an evident change of water temperature in the deeper water layers.

Water temperature changes are important, since they affect chemical and biological processes in lakes and have a significant impact on the overall condition in them. Aquatic species have preferred temperature ranges for living, but in general biological activity and growth rate of aquatic organisms are higher when water temperature increases (Lampert, 1984). During the study carried out in three other Slovenian mountain lakes (i.e. Krnsko jezero, Jezero v Ledvicah and Jezero na Planini pri Jezeru), primary producers were less abundant in the years with long duration of snow and ice cover and consequently cold lake water temperatures. The overall conditions in these lakes have improved in comparison with those in the years with warmer lake water (Muri & Brancelj, 2003).

#### CONCLUSIONS

Changes of the daily air temperature and amount of precipitation were measured at the lodge Pogačnikov dom at Kriški podi in July 2002. These changes were compared with the surface water temperature variations in Zgornje, Srednje and Spodnje Kriško lakes. Significant correlation was found between the three measured parameters. Vertical water temperatures were additionally measured in Srednje Kriško lake and the heat content was calculated. It was established that water temperature variations in the deeper layers of the water column were less correlated with the changes of meteorological parameters. A longer time was also needed to warm up its bottom water layers. The calculation of heat content showed that approximately two thirds of the total heat

content is stored in the upper, epilimnetic waters. The metalimnetic waters comprised around one third of the total heat content, while the heat stored in the hypolimnetic waters was of minor importance.

Water temperature changes in lakes are important, since they affect chemical and biological processes in them, and can thus change their overall conditions.

#### ACKNOWLEDGEMENTS

The minithermistor data were obtained within the framework of the EU project EMERGE. A. Brancelj is acknowledged for kindly providing these data. We are also grateful to M. Šiško for the bathymetric data of Srednje Kriško lake. The manuscript gained from the helpful comments of J. Fagnani and one anonymous reviewer.

### ODNOS MED TEMPERATURO ZRAKA, PADAVINAMI TER NIHANJEM POVRŠINSKE IN GLOBINSKE TEMPERATURE VODE V TREH KRIŠKIH JEZERIH (JULIJSKE ALPE, SZ SLOVENIJA) V JULIJU 2002

Gregor MURI

Nacionalni inštitut za biologijo, SI-1000 Ljubljana, Večna pot 111

Saša ERŽEN

Študentka na Oddelku za geografijo, Filozofska fakulteta, SI-1000 Ljubljana, Aškerčeva 2

#### POVZETEK

Pri Pogačnikovem domu na Kriških podih smo julija 2002 merili dnevno temperaturo zraka in količino padavin. Poleg tega smo odčitavali površinsko temperaturo vode v Zgornjem, Srednjem in Spodnjem Kriškem jezeru, medtem ko smo v Srednjem Kriškem jezeru merili temperaturo vode tudi po globini vodnega stolpca, iz česar smo nato izračunali porazdelitev toplote v tem jezeru. Opazili smo precejšnja nihanja površinske temperature vode. V Zgornjem Kriškem jezeru je površinska temperatura vode nihala za 7.2°C, v Spodnjem Kriškem jezeru pa za 4.5°C. Spremembe povprečne dnevne temperature zraka in količine padavin so bile medsebojno povezane s spremembami površinske temperature vode. Korelacija med temperaturo vode v globljih plasteh vodnega stolpca in meteorološkimi parametri je bila slabša. Tudi nihanja temperature vode so bila v globljih plasteh vodnega stolpca manjša, saj je v hipolimniju Srednjega Kriškega jezera temperatura nihala le za 2°C. Spreminjali pa sta se debelini epilimnija in metalimnija v času študije v tem jezeru. Debelina epilimnija je narasla od dva na tri metre, medtem ko se je debelina metalimnija skrčila iz štirih na dva metra, ko so dnevi postajali toplejši. Debelina hipolimnija je bila v času študije enaka in je znašala okrog dva metra. Izračun porazdelitve toplote v Srednjem Kriškem jezeru je pokazal, da je vrhnja plast vode (0-2 m) vsebovala približno 65% celotne toplote v jezeru. Območje 2-5 m je vsebovalo okrog 31%, predel 5-8 m pa le še 4% celotne toplote v jezeru.

**Ključne besede:** temperatura zraka, temperatura vode, toplota, alpska jezera

## REFERENCES

- Ambrosetti, W & L. Barbanti (2001):** Temperature, heat content, mixing and stability in Lake Orta: a pluriannual investigation. *J. Limnol.*, 60, 60-68.
- Antonopoulos, V. Z. & S. K. Gianniu (2003):** Simulation of water temperature and dissolved oxygen distribution in Lake Vegoritis, Greece. *Ecol. Model.*, 160, 39-53.
- Brancelj, A. (ed.) (2002):** High-mountain lakes in the eastern part of the Julian Alps. ZRC Publishing, Ljubljana.
- Kastelec, D. (1999):** Use of universal kriging for objective spatial interpolation of average yearly precipitation in Slovenia. *Res. Rep. Biotech. Fac. Univ. Ljublj. Agric. Issue 73*, 301-314 (in Slovenian, with English abstract).
- Koinig, K. A., R. Schmidt, S. Sommaruga-Wögrath, R. Tessadri & R. Psenner (1998):** Climate change as the primary cause for pH shifts in a high alpine lake. *Wat. Air Soil Pollut.*, 104, 167-180.
- Lampert, W. (1984):** The measurement of respiration. In: Downing, J. A. & Rigler, F. H. (ed.): *A manual on methods for the assessment of secondary productivity in fresh waters*. Oxford, Blackwell, 413-468.
- Muri, G. & A. Brancelj (2003):** Seasonal water chemistry variations in three Slovenian mountain lakes. *Acta Chim. Slov.*, 50, 137-147.
- Ottosson, F. & O. Abrahamsson (1998):** Presentation and analysis of a model simulating epilimnetic and hypolimnetic temperatures in lakes. *Ecol. Model.*, 110, 233-253.
- Skjelkvale, B. L. & R. F. Wright (1998):** Mountain lakes; sensitivity to acid deposition and global climate change. *Ambio*, 27, 280-286.
- Stumm, W. & J. J. Morgan (1996):** Aquatic chemistry, chemical equilibria and rates in natural waters. Wiley Interscience Publication, New York.
- Wathne, B. M., B. O. Rosseland, (Eds.), (2000):** MOLAR Final Report 4/1999. Measuring and modelling the dynamic response of remote mountain lake ecosystems to environmental change: A programme of Mountain Lake Research - MOLAR. NIVA, Oslo.
- Wetzel, R. G. (1983):** Limnology. Saunders College Publishing, Philadelphia.

pregledni članek  
prejeto: 2003-04-11

UDK 556.36(497.4 Kras)

## KRAŠKI IZVIRI BISTRICE (JZ SLOVENIJA)

Gregor KOVAČIČ  
Fakulteta za humanistične študije Koper, Univerza na Primorskem, SI-6000 Koper, Glagoljška 8  
E-mail: gregor.kovacic@fhs-kp.si

## IZVLEČEK

Stalni in občasni kraški izviri v okolici Ilirske Bistrice (JZ Slovenija) z ocenjenim skupnim srednjim letnim pretokom 1.850 m<sup>3</sup>/s pritekajo na površje na stiku krednih apnencev in eocenskega fliša na zahodnem robu dobro namočene Snežniške planote, ki tektonsko pripada Snežniški narivni grudi. Hidrografsko zaledje izvirov je neposeljena Snežniška planota, kar je za varovanje kakovosti pitne vode v izviri ugodno. Kljub temu v zaledju najdemo manjše število bolj ali manj resnih potencialnih in dejanskih onesnaževalcev. Mikrobiološka in fizikalno kemijska kakovost vode v izviri Bistrice, ki je tudi zajet za vodooskrbo, je dobra, toda vodovarstveni pasovi niso opredeljeni in varstvenega režima tu ne uresničujejo.

**Ključne besede:** kraški izvir Bistrice, kraška hidrologija, Snežniška planota, JZ Slovenija

## SORGENTI CARSICHE DI BISTRICA (SLOVENIA SUD-OCCIDENTALE)

## SINTESI

Le sorgenti carsiche permanenti ed intermittenti nei pressi di Ilirska Bistrica (Slovenia sud-occidentale), con un flusso totale medio annuo di 1.850 m<sup>3</sup>/s, sgorgano in superficie al contatto tra calcari gessosi e flysch eocenico, sul ciglione occidentale della ben irrigata pianura di Snežnik che, tettonicamente parlando, appartiene alla zolla naturale di Snežnik. Il retroterra idrografico delle sorgenti è costituito dalla non popolata pianura di Snežnik, il che è un vantaggio per la tutela della qualità dell'acqua potabile proveniente dalle sorgenti. Nonostante ciò nel retroterra troviamo un discreto numero di inquinanti potenziali o effettivi. La qualità microbiologica e fisico-chimica dell'acqua alla sorgente di Bistrice, alla quale si attinge per l'approvvigionamento idrico, è buona, benché le fasce di tutela dei corsi d'acqua non siano state definite e il regime di protezione non sia stato messo in atto.

**Parole chiave:** sorgente carsica Bistrice, idrologia carsica, pianura di Snežnik, Slovenia sud-occidentale



## UVOD

Kraški izvir Bistrica in izviri v njegovi okolici do sedaj niso vzbudili velikega zanimanja pri raziskovalcih, čeprav je že leta 1938 o kakovosti in pretokih zajetja Bistrica ter legi posameznih izvirov v njegovi okolici poročal Boegan. Tako v literaturi najdemo le tu in tam nekaj podatkov o fizikalno-kemični kakovosti in izdatnosti izvira Bistrica (Brečko-Grubar & Plut, 2001), nekoliko več pa je zapisanega o Bistrici kot o najmočnejšem kraškem pritoku svetovno znane ponikalnice Reke (Rojšek, 1987, 1996).

Bistrica je kljub majhni izdatnosti eden pomembnejših kraških izvirov v jugozahodni Sloveniji (Brumen *et al.*, 1991), saj s pitno vodo oskrbuje večji del občine Ilirska Bistrica, nekaj naselij v občini Hrpelje-Kozina ter del Republike Hrvaške. V zvezi s pripravo strokovnih podlag za sprejetje odloka o zavarovanju pitne vode iz omenjenega izvira je bilo po naročilu Občine Ilirska

Bistrica in upravljavca zajetja, Komunalnega podjetja Ilirska Bistrica, opravljenih več hidrogeoloških raziskav zaledja (Juren & Krivic, 1989; Petauer *et al.*, 2002), žal brez sledilnih poskusov in vrtin. Zbranih je bilo tudi nekaj podatkov o izdatnosti ter fizikalno-kemičnih značilnostih vode iz zajetja.

Celovitega opisa geografskega položaja izvirov v neposredni bližini mesta Ilirska Bistrica v povezavi s hidrološkimi razmerami v zaledju še nimamo, zato je besedilo pomemben prispevek k boljšemu poznavanju hidrološke situacije na tem območju jugozahodne Slovenije.

## GEOGRAFSKI POLOŽAJ STALNIH IN OBČASNIH KRAŠKIH IZVIROV

Stalne in občasne kraške izvire pri Ilirski Bistrici lahko obravnavamo kot enoten hidrološki sistem. Izviri so razporejeni ob zahodnem vznožju Snežniške planote

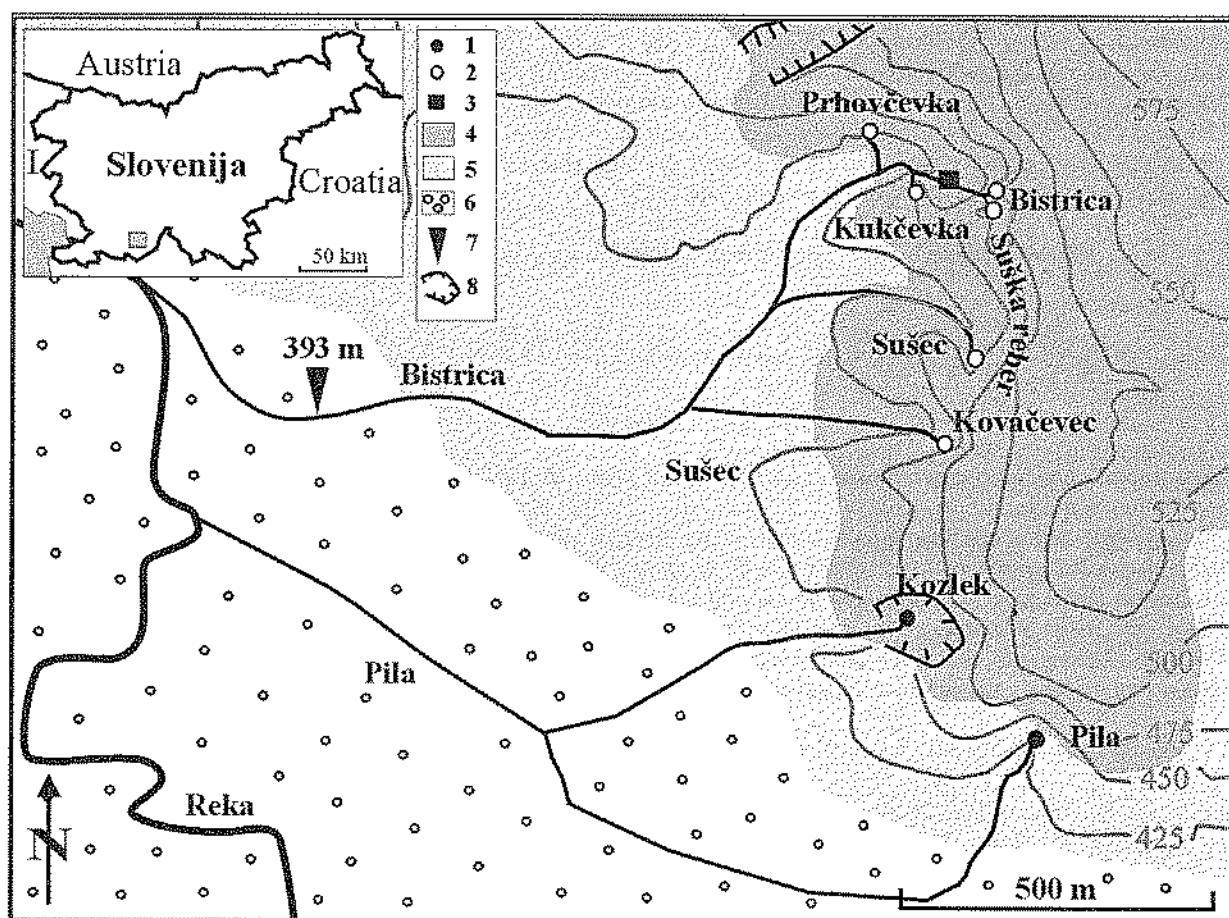

Sl. 1: Geografski položaj obravnavanih izvirov. Legenda: 1. Stalni izvir, 2. Občasni izvir, 3. Zajetje za vodovod, 4. Kredni apnenci, 5. Eocenski fliš, 6. Rečni sedimenti, 7. Vodomerne postaja Ilirska Bistrica, 8. Kamnolom.  
Fig. 1: Geographic position of the karst springs. Legend: 1. Permanent spring, 2. Periodical spring, 3. Water supply capture, 4. Cretaceous limestones, 5. Eocene flysch, 6. Fluvial sediments, 7. Ilirska Bistrica gauging station, 8. Quarry.

oziroma Snežniškega pogorja, kjer kraški svet, zgrajen iz apnencev, dolomitov, apnenčastih in dolomitnih breč pretežno kredne starosti, v stopnji prehaja v flišne sedimente brkinske sinklinale. Vode na dan prisili v podlagi slabo prepusten fliš, prek katerega so narinjene karbonatne kamnine Snežniške narivne grude. Kraški rob na tem delu ni tako izrazit, kot ga denimo lahko opazujemo v zatrepni dolini kraškega izvira Podstenjšek severozahodno od tod ali pa vzdolž toka Reke jugovzhodno od obravnavanih izvirov. Kljub temu se apniški svet v Suški rebri na zelo kratki razdalji spusti več kot 100 m do flišne podlage ilirskobistriške kotline. Lokalno erozijsko bazo izvirov tvori Reka, ki v okolici Ilirske Bistrice vijuga po svoji poplavni ravnici. Reka je svoje osamljeno porečje razvila na neprepustnih flišnih kamninah, ki jih z vseh strani omejujejo dobro prepustne kraške kamnine z bolj ali manj razvitimi kraškimi vodonosniki.

Preučevani izviri, ki so razporejeni na razdalji približno enega kilometra, se v Reko stekajo v dveh pritokih (Sl. 1). Pritok Bistrica, ki je dolg vsega skupaj 1,65 km (Rojšek, 1996), se napaja z izviri Bistrice ter izvirova Sušec in Kovačevce. Relativna višinska razlika med izvirov in izlivom je približno 30 m. Bistrica je najmočnejši kraški pritok Reke, z zelo pomembnim učinkom kraške retinence v sušnih obdobjih, ko ima ta malo vode. Pritok Pila oziroma Kozlek se napaja iz istoimenskih kraških izvirov.

Bistrica izvira pod prepadnimi stenami na stiku apnenca in fliša v značilni zatrepni dolini neposredno za zadnjimi hišami najstarejšega predela Ilirske Bistrice, imenovanega Sibirija, na nadmorski višini 425 m (Sl. 2). Zajetje za pitno vodo, ki mu pravijo Pod steno in je 90 m umetno izkopani drenažni rov, leži nekaj metrov nižje. Za omenjeno zajetje oziroma vodni vir se poleg izvira Bistrice uporablja še ime Pod Gradino, Sibirija ali pa vodni vir Ilirska Bistrica. Izvir je pozidan, tako da naravnega iztoka vode ni (Sl. 3). Nad zidanimi rezervoarji najdemo dva hudourniška jarka, ki segata do nadmorske višine 475 m in se zaključujeta z manjšo steno. Pobočja zatrepne doline so prekrita z gruščem. Kaže, da voda po hudournikih v izvir priteče le ob izjemnih padavinah. Drenažni rov sedanjega zajetja, ki leži na nadmorski višini 420 m, usmerja podzemni tok vode iz ožje okolice in širšega zaledja naravnost v zajetje pitne vode. V zatrepni dolini Bistrice izvirata še dva občasna kraška izvira, ki privreta na dan ob visokih vodah. Kukčevka je manjši slap, ki izvira iz skalne razpoke in se že po nekaj metrih toka združi z Bistrico. Kukčevka leži znotraj I. vodovarstvenega območja zajetja, ki je ograjeno. Z desne strani iz razpoke v steni privre na dan Prhovčevka, ki se v skočnikih med poslopji po nekaj 10 m izliva v Bistrico. Struga Bistrice je utrjena s kamnitimi brežinami od zajetja pa skoraj do izliva v Reko. Strnjena pozidava vzdolž struge v ozki zatrepni dolini je vezana na nekdanjo izrabo pogonske moči vodnega toka za delovanje

žag in mlinov (Sl. 4). Dejavnost te vrste je povsem zamrla, nekdanji mlini in žage pa so v razvalinah.

Sušec je levi pritok Bistrice, ki izvira iz strme apniške stene na koncu manjše zatrepne doline. Zatrepna dolina Sušca in Bistrice sta med seboj ločena z nizkim in kratkim, toda dokaj izrazitim slemenom. Sušec je najslabovitejši izmed obravnavanih izvirov. Voda izvira iz razpok v steni in pada v obliki dveh manjših slapov in skočnikov (Sl. 5). Sušec je občasen izvir, višina izviranja vode pa je v precejšnji meri odvisna od trenutne hidrološke situacije. V običajnih razmerah voda privre na dan iz razpok v skalovju na višini približno 425 m, ob visokih vodah pa slap izvira iz apnenčastega gruščja ob vznožju manjših podornih sten v strmem pobočju Suške rebri tudi od 10 do 15 m višje. Hudourniške grape je moč opazovati vse do skrajnega vrhnjega roba zatrepne doline nekaj 10 metrov višje, kjer se opazni tudi manjši podori. Sušec se hitro odzove na padavine v zaledju, kar se kaže v hitrem naraščanju in upadanju pretoka.

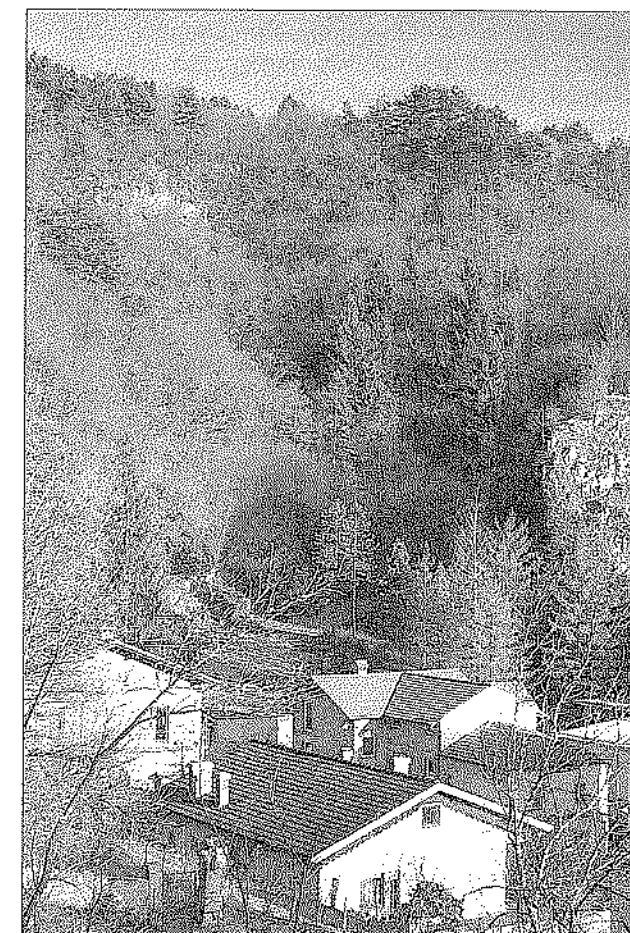

Sl. 2: Zatrepna dolina kraškega izvira Bistrica. (Foto: G. Kovačič)  
Fig. 2: Pocket valley of the Bistrica karst spring. (Photo: G. Kovačič)

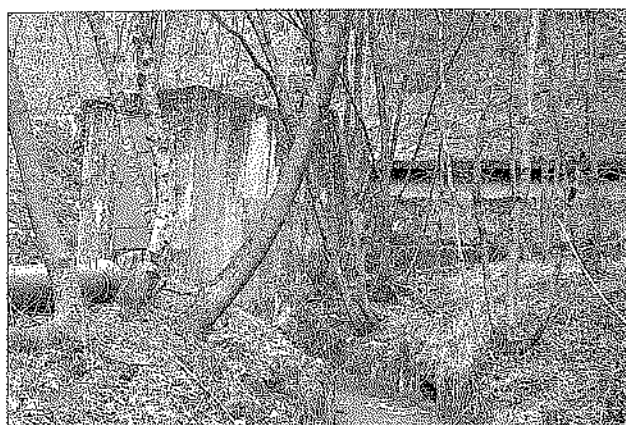

Sl. 3: Izvir Bistrice je za vodooskrbo zajet že na začetku. (Foto: G. Kovačič)

Fig. 3: The Bistrice karst spring is tapped for water supply at its very source. (Photo: G. Kovačič)

Kovačevcevec je manjši občasni izvir, ki prihaja na dan iz razpok v steni na kraju neizrazite in kratke zatrepne doline. Ob srednjih in nizkih vodah izvira voda izpod stene na nadmorski višini 430 m. Ob dvigu nivoja podzemne vode voda izvira 15 m više neposredno iz gruščca, ki se napaja skozi razpoke v apnenčasti podlagi. Ob visokih vodah se v neposredni bližini aktivira manjši slap, ki priteče iz korozijsko razširjene razpoke v apnenčasti steni.

Kozlek izvira na območju opuščene kamnoloma in je eden izmed stalnih izvirov na območju. Voda izvira na nadmorski višini 440 m iz podornega kamenja, ki leži pod manjšo steno. Izvir hitro reagira na padavine s povečanim pretokom, potem pa sledi dolgo obdobje izredno nizkih pretokov. Ob izviru se je med deli v kamnolomu odprla krajša jama, ki jo v svojem delu opisuje Boegan (1938).

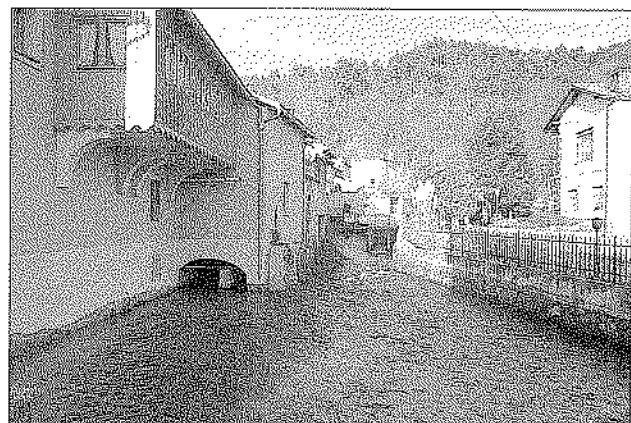

Sl. 4: Stari del Ilirske Bistrice, imenovan Sibirija. (Foto: G. Kovačič)

Fig. 4: The old part of the town of Ilirska Bistrica named Sibirija. (Photo: G. Kovačič)

Pila je manjši kraški izvir, ki prihaja na dan ob stiku apnenca s flišem ob visokih vodah na nadmorski višini približno 470 m. Število posameznih izvirov na lokaciji in njihova višina sta močno odvisna od trenutne hidrološke situacije, saj se ob visokih vodah število izvirkov na lokaciji poveča, ob nizkih vodah pa voda izvira precej niže. Ob padavinskih viških voda išče pot skozi območja slabše prepustnosti v apnenčastem grušču, ki prekriva pobočje pod manjšimi stenami kraškega roba. Posledica je zelo povečan pretok v potoku, ki je običajno zelo majhen, vendar stalen.

#### HIDROLOŠKE ZNAČILNOSTI IZVIROV IN NJIHOVO ZALEDJJE

Hidrografska zaledje izvirov je razmeroma dobro omejeno samo s flišnim obrobjem ob Reki, ki teče vzporedno z bolj ali manj izrazitim kraškim robom zahodnega dela Snežniške planote v značilni dinarski smeri. Strma pobočja pod robom prekrivajo apneni gruščci, sestavljeni iz skalnih odkruškov različnih velikosti. Ti značilno prekrivajo tudi rebri krajnih koncev zatrepnih dolin kraških izvirov. Flišne kamnine v talnini snežniške narivne grude (Placer, 1981) so za podzemne kraške vode nekakšna hidrološka pregrada, kar usmerja podzemni tok kraške vode z zahodnega roba Snežniške planote v porečje Pivke. V njenem zgornjem toku prihaja do bifurkacije med jadranskim in črnomořskim povodjem (Habič, 1984). Kaže, da je flišna pregrada prebita samo na območju obravnavanih izvirov in pri kraškem izviru Podstenjšek. Obseg kraškega zaledja izvirov v notranjosti Snežniške planote je po do sedaj razpoložljivih podatkih praktično nemogoče opredeliti, saj je hidrografska meja med napajalnim zaledjem Bistrice, Pivke, Cerkniškega jezera in Riječine (Hrvaška) zelo nejasna in verjetno prostorsko in časovno močno spremenljiva glede na padavinske in hidrološke razmere na območju. Sledilnih poskusov na območju niso napravili. Ocena, da hidrografska zaledje kraškega izvira Bistrice obsega površino približno 90 km<sup>2</sup> (Juren & Krivic, 1989; Petauer *et al.*, 2002), je nekoliko pretirana. Kljub temu je s stališča varovanja pitne vode smiselna, saj so jo zaradi slabšega poznavanja terena in da bi se izognili morebitnim nepremišljenim posegom v naravo, pomaknili do roba izrazitega dinarskega preloma, kjer so opazne vidne geološke spremembe terena.

Z izjemo Pile in Kozleka vodomerna postaja Ilirska Bistrica (Bistrica) zajema vode vseh obravnavanih kraških izvirov. Postaja leži na nadmorski višini 393 m v bližini izliva Bistrice v Reko. Po hidroloških podatkih za obdobje 1958 do 1998 (v letih od 1974 do 1989 meritev niso opravljali) se srednji letni pretoki sučejo med 0,86 in 2,56 m<sup>3</sup>/s ( $Q_s = 1,6 \text{ m}^3/\text{s}$ ) (HMZ RS, 1999), pri tem pa je treba v skupni bilanci iztoka vode upoštevati odvzem vode za potrebe vodovoda, ki je neodvisno od letnega časa približno 0,100 m<sup>3</sup>/s. Minimalni pretoki se gibljejo

med 0,044 in 0,560 m<sup>3</sup>/s in so dolgotrajnejši. Maksimalni pretoki med 3,39 in 36,50 m<sup>3</sup>/s so kratkotrajni, ekstremni viški pa se pojavljajo hkrati z izjemnimi padavinskimi dogodki v zaledju. Pretok Bistrice skoraj polovico dni v letu ni večji od 1 m<sup>3</sup>/s. Indeks preplavljenosti znaša 1 : 36 : 830, kar kaže na sistem dobro razvite kraške poroznosti z zelo hitrim tokom in istočasno na omejeno sposobnost skladiščenja v vodonosniku. Če upoštevamo odvzem, se vrednost indeksa preplavljenosti zmanjša na 1 : 12 : 254. Zaradi slabše prepustnosti stalnih in niže ležečih izvirov se ob močnejših padavinah nivo podzemne vode dvigne. Potek praznjenja vodonosnika zaznamuje hitri upad povečanih pretokov v više ležečih izviroh. Do znatnejšega upada pretoka, ki je posledica upada gladine podzemne vode v zaledju, prihaja najprej pri Pili, sledijo Kozlek in drugi izviri do kraškega izvira Bistrica. Prepustnost slednjega je precej omejena, kar se ob močnejših padavinah kaže v povečanem pretoku v občasnih izviroh. Slabša prepustnost stalnih izvirov je verjetno tudi posledica dejstva, da tam ni izvirkov, ki jih lahko opazujemo v kraških izviroh drugod po Sloveniji in svetu. Možno je, da sicer obstajajo manjše izvirske jame, ki pa so bodisi zapolnjene in tako slabše prevodne bodisi zasute s pobočnim gruščem in jih zato ni opaziti. Možno je tudi, da se preprosto končajo z zapletenim sistemom številnih razpok v skalovju, ki so pogoste na naravnem robu. Vloge tektonske pretrnosti naravnega roba na razporeditev izvirov in na njihove hidrološke posebnosti ne gre zanemarjati, čeprav ta še ni pojasnjena.

V hidroloških podatkih za vodomerno postajo Ilirska Bistrica nista zajeta izvira Pila in Kozlek. Podatkov o njihovih pretokih nimamo, vendar skupni srednji letni pretok v seštevku verjetno ne presega 0,150 m<sup>3</sup>/s.

Minimalna izdatnost kraškega izvira Bistrica je ocenjena na 0,200 m<sup>3</sup>/s (Kovačič, 2001a), kar je približno toliko, kot je izmerjeni srednji minimalni pretok Bistrice na vodomerni postaji Ilirska Bistrica. V sušnih mesecih se Bistrica polni pretežno z vodo iz omenjenega izvira. Prva merjenja pretokov kraškega izvira Bistrica so bila opravljena že ob koncu devetnajstega in v začetku prejšnjega stoletja, rezultate o meritvah pa je v svojem delu zapisal Boegan (1938). V obdobju med 1870 in 1928 je bila zabeležena minimalna izdatnost 0,116 m<sup>3</sup>/s (1. 9. 1911) ter maksimalna izdatnost 3,18 m<sup>3</sup>/s (27. 3. 1928). V istem delu so zabeleženi rezultati nekaj meritev pretoka na občasni kraški izviri Sušec in Kovačevcevec in letu 1928. Pretoki Sušca se gibljejo med 0,160 in 0,820 m<sup>3</sup>/s, pretoki Kovačevca pa med 0,001 in 0,472 m<sup>3</sup>/s, avtor pa navaja, da omenjena izvira v sušnih poletnih mesecih popolnoma presahneti. Pomankljivost podatkov o pretokih je, da niso dovolj reprezentativni, saj merjenj niso opravljali sistematično v vseh letnih časih. Tako denimo nimamo podatkov o pretokih v zimskih mesecih in še posebej v mesecu novembru, ko so izviri najbolj izdatni. Kljub temu dajejo

pomembno informacijo, saj novejših podatkov nimamo.

Časovna razporeditev srednjih mesečnih pretokov Bistrice pokaže dva letna viška. Prvi in izrazitejši višek se časovno ujema z veliko količino padavin v mesecu novembru, ki je med vsemi meseci v letu najbolj namočen. Visoki pretoki se ohranjajo do meseca februarja, ko nastopi manj izraziti nižek. Sekundarni višek pretokov se pojavlja v mesecu aprilu. Primarni nižek se pojavlja v poletnih mesecih. Nadpovprečni srednji mesečni pretoki so značilni za hladno polovico leta, z izjemo meseca februarja, ko so pretoki nekoliko nižji od letnega povprečja. Sekundarni aprilski višek je posledica taljenja snega v pomladanskih mesecih, saj zimski in spomladanski meseci odražajo podpovprečne vrednosti količine padavin. Vendar pa učinek taljenja snega v zaledju ni posebej izrazit, saj srednji aprilski pretok le malo presega srednji letni povprečni pretok in je tudi manjši od pretokov v mesecih od oktobra do januarja. Napajalno zaledje izvirov potemtakem obsega tudi območja, ki jih pozimi prekriva sneg, vendar gre tu za predele s tanjšo in manj časa trajajočo snežno odejo.

Ocenjeni skupni srednji letni odtok iz obravnavanih izvirov znaša približno 1.850 m<sup>3</sup>/s. Ob predpostavki, da so spremembe v količini uskladičenja vode v dolgoletnem obdobju enake 0, lahko na podlagi podatkov o količini padavin v zaledju in podatku o evapotranspiraciji ocenimo velikost zaledja izvirov. Seveda gre zgolj za površno oceno, saj na napajanje kraškega vodonosnika vplivajo še številni drugi dejavniki, kot sta denimo taljenje snega in prestrezanje padavin na rastlinskem pokrovu (Petrič, 2002). Poleg tega gre za oceno velikosti zaledja, ne pa tudi obsega in njegovih mej. Skupna letna količina padavin na padavinski postaji Ilirska Bistrica, ki leži dober kilometer severneje od izvirov, znaša 1446,8 mm (Zupančič, 1995), korigirana vrednost pa 1569 mm (Kolbezen & Pristov, 1998). Hidrografska zaledje izvirov

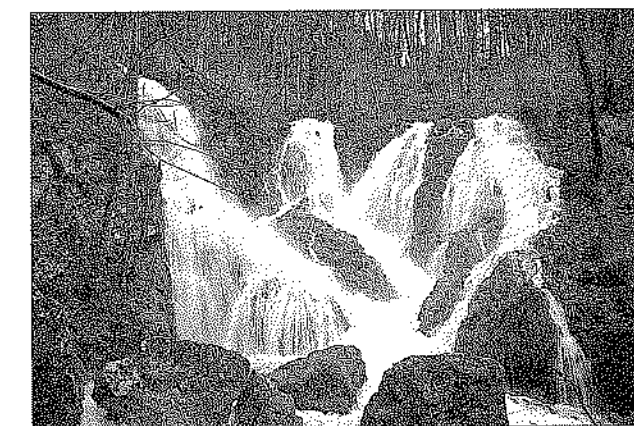

Sl. 5: Kraški izvir Sušec ob visoki vodi novembra 2002. (Foto: G. Kovačič)

Fig. 5: High discharge of the Sušec spring in November 2002. (Photo: G. Kovačič)



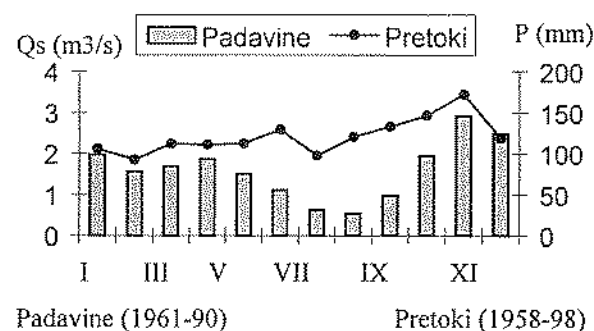

Sl. 6: Povprečni mesečni pretoki Bistrice v obdobju 1958-98 na vodomerni postaji Ilirska Bistrica in povprečne mesečne padavine v obdobju 1961-90 na padavinski postaji Ilirska Bistrica (HMZ RS, 1999; Zupančič, 1995).

Fig. 6: The Bistrica monthly mean discharges (period 1958-98) at the Ilirska Bistrica gauging station and monthly mean precipitation (period 1961-90) at the Ilirska Bistrica precipitation station (HMZ RS, 1999; Zupančič, 1995).

je dobro namočeno. Proti notranjosti Snežniške planote padavine zaradi orografske pregrade naraščajo ter na zahodnem robu Snežniške planote in v povirnem delu Reke presežejo 1800 mm. Podatki za Mašun (2041 mm/letno) in južneje ležeče Gomance (2738 mm/letno) kažejo, da se količina padavin proti osredju planote še večja in znaša približno 2500 mm, na najvišjih predelih pa celo 3000 mm. Snežniška planota je v povprečju 100 dni na leto pokrita s snežno odejo, njena letna maksimalna višina pa se giblje med 20-200 cm (Kolbezen & Pristov, 1998; Zupančič, 1998; Kovačič, 2001). Višja nadmorska lega zaledja in posledično nižje temperature povzročajo slabše izhlapevanje, prepustna karbonatna kamninska podlaga pa omogoča hitro prenikanje vode v globino, kar tudi zmanjšuje možnost izhlapevanja, povečuje pa podzemni vodni odtok z območja. Če vzamemo 1800 mm padavin kot povprečno množino padavin v zaledju in upoštevamo 620 mm letnega izhlapevanja ter obe vrednosti primerjamo s skupnim letnim srednjim odtokom skozi izvire, dobimo podatek, da napajalno zaledje izvirov obsega površino približno 50 km<sup>2</sup>. Gre zgolj za približek, saj so omenjene vrednosti, z izjemo srednjega letnega odtoka skozi izvire, ocenjene na podlagi Kolbenz & Pristovih (1998) izračunov. Za natančnejšo oceno velikosti zaledja bi bila potrebna sistematična merjenja izdatnosti izvirov in jasnejša opredelitev količine padavin ter izhlapevanja v zaledju, kot dveh pomembnejših dejavnikov napajanja.

Hidrografsko zaledje izvirov sestavlja visoki kras Snežniške planote, ki je izoblikovan v dobro do srednje prepustnih krednih ter deloma jurskih in paleogenskih apnencih, dolomitih, apnenčastih in dolomitnih brečah, ki so tektonsko zelo pretrti, kar še povečuje njihovo prepustnost (Šikić et al., 1972; Šikić & Pleničar, 1975).

Podrobnejšo geološko zgradbo območja opisuje slika 7. V narivni zgradbi jugozahodne Slovenije kamnine pripadajo Snežniški narivni grudi (Placer, 1981). Ta je na svojem zahodnem robu narinjena prek flišnih plasti brkinske sinklinale, ki je del Komenske narivne grude. Dokaz za to sta tektonski okni pri Zagorju in Knežaku (Pleničar, 1968). Neprepustni fliš v podlagi prisili podzemne vode na dan v obravnavanih izviroh. Na območju izvirov gre tako za značilen primer kontaktnega krasa z manjšimi zatrepnimi dolinami. Tu in tam se na Snežniški planoti v omejenem obsegu pojavljajo tudi ledeniške morene in aluvialne naplavine. Večinoma gre za pesek in slabo zaobljen prod moren pobočnih ledenikov, ki so se v pleistocenu raztezali s Snežnika v različnih smereh (Šifrer, 1959).

Snežniška planota se na zahodu in jugozahodu zaključuje s kraškimi robom nad dolino Reke, na severovzhodu je omejena z Notranjskim podoljem, na severozahodu pa v blagem pregibu prehaja v kraško Zgornjo Pivko. Skupaj z Javorniki na severu in Gorskim kotarjem na jugu in jugovzhodu tvori zaokroženo morfološko enoto s skupnimi značilnostmi. Večina površja na Snežniški planoti sega v višine med 1000 in 1400 m, najvišji vrh je Snežnik (1796 m). Območje je polno vrtač različnega nastanka in velikosti, brezen, med katerimi je Brezno Bogumila Brinška s 506 m globine najgloblje do sedaj odkrito ter značilnih kraško ledeniških globeli (Velika Padežnica, Vaľa, Grda draga ...). Kraške jame na območju niso znane.

Snežniška planota pripada hidrološkemu tipu globokega raztočnega krasa. Za ta tip krasa je pomembna avtohtona padavinska voda, ki prenika v kraško podzemlje in odteka v različne smeri proti kraškim izvirov na obrobju. Snežniška planota je razvodno območje, saj se jugovzhodni del njenega ozemlja odmaka v porečje Riječine, severovzhodni in severni predeli pripadajo črnomorskemu povodju, zahodni predeli pa napajajo maloštevilne kraške izvire, ki prihajajo na dan ob stiku s flišem in so sestavni del porečja Reke. Možno je, da se skozi razpoke deloma kraško polnijo tudi manjši izviri narivnega kraškega roba jugovzhodno od Ilirske Bistrice. Ti se napajajo skozi apnenčasti pobočni grušč in nato izvirajo na točkah manjše prepustnosti ter sestavljajo desne pritoke Reke. Kljub dejstvu, da Reka s svojo dolino v višini približno 400 m oblikuje glede na preostalo obrobje Snežniške planote relativno zelo nizko lokalno erozijsko bazo, je količina podzemne vode, ki se usmerja v izvire proti zahodnemu robu Snežniške planote, dokaj majhna. Hidrografsko zaledje obravnavanih izvirov obsega tako le manjši del Snežniške planote, glavina precej izdatnih padavin pa odteka v porečje Pivke (555 m) in Cerknjskega jezera (555 m) ter Riječine (350 m). Verjetno gre za vpliv geološke zgradbe v povezavi s tektonskimi strukturami in paleogeografskim razvojem območja.

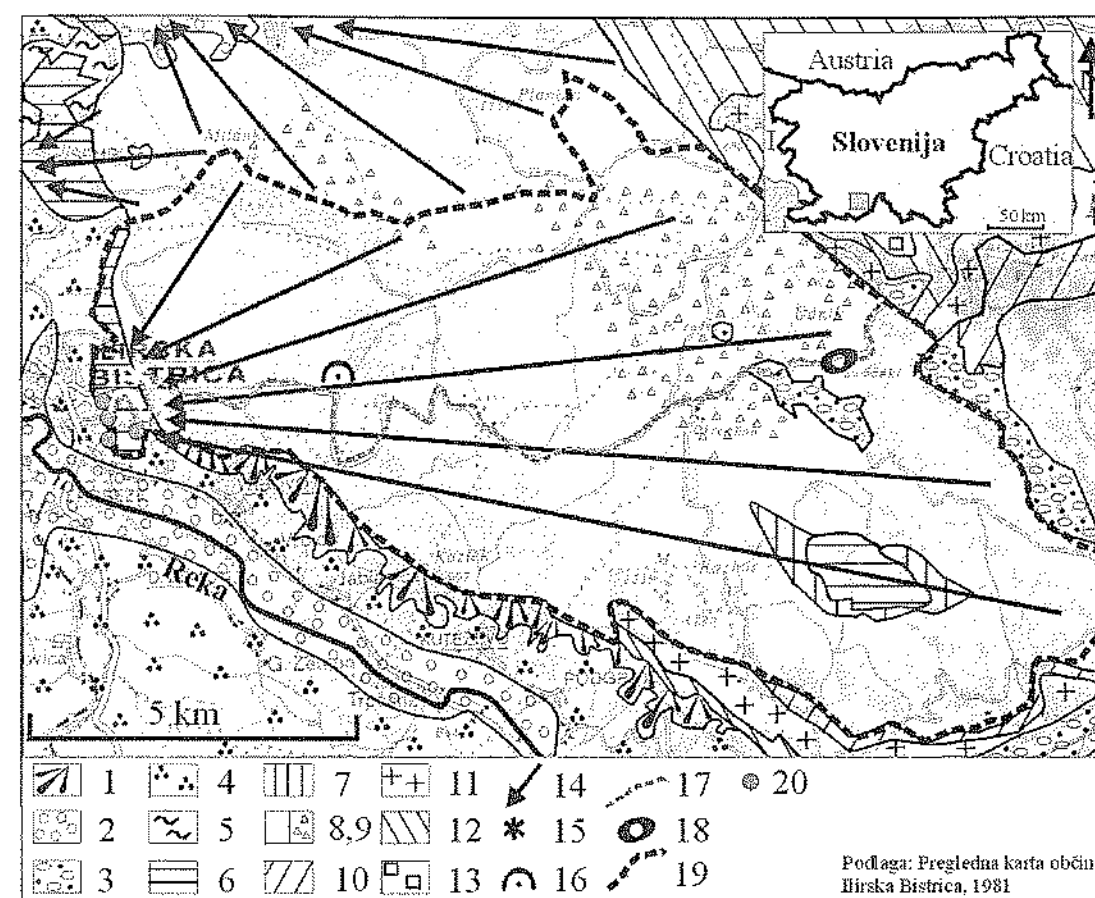

Sl. 7: Geološka zgradba hidrografskega zaledja izvirov in njihovi potencialni onesnaževalci (prirejeno po: Šikić et al., 1972; Petauer et al., 2002; Kovačič, 2001b) Legenda: 1. Pobočni grušč (holocen), 2. Aluvialni nanosi (holocen), 3. Glaciofluvialni sedimenti (pleistocen), 4. Flišni sedimenti: menjavanje glinovcev, laporovcev, peščenjaka, kalkarenitov, breč in konglomeratov (eocen), 5. Svetlosivi in sivi ter sivorjavi do črni apnenci do lapornati apnenci (paleogene), 6. Svetlosivi in beli prekrizalizirani apnenci (zg. kreda), 7. Menjavanje plasti svetlih apnencev in dolomitov (zg. kreda), 8. Svetli apnenci (sp. in zg. kreda), 9. Dolomitno apnena breča (sp. in zg. kreda), 10. Apnenec in dolomit (sp. kreda), 11. Svetlosiv apnenec (zg. jura), 12. Svetlosiv in temnosiv apnenec (zg. jura), 13. Temnosivi debeložrnati dolomit v menjavanju z apnencem (zg. jura), 14. Domnevni podzemeljski dotok vode, 15. Trap-športno strelišče, 16. Kamnolom, 17. Lokalna cesta, 18. Turistično naselje Sviščaki, 19. Predlagana meja vodovarstvenega območja, 20. Kraški izvir.

Fig. 7: Geological map of the karst springs' hinterland and their potential pollutants (after: Šikić et al., 1972; Petauer et al., 2002; Kovačič, 2001b) Legend: Slope rubble (Holocene), 2. Alluvial sediments (Holocene), 3. Glaciofluvial deposits (Pleistocene), 4. Flysch rocks: shales, marlstones, sandstones, calcarenites, breccias and conglomerates, 5. Light grey and grey limestones, grey brown and black limestones and marly limestones (Paleogene), 6. Light grey and white crystalline limestones (Upper Cretaceous), 7. Aletinating light limestones and dolomites (Upper and Lower Cretaceous), 8. Light limestones (Upper and Lower Cretaceous), 9. Dolomite-limestone breccia (Upper and Lower Cretaceous), 10. Limestone and dolomite (Lower Cretaceous), 11. Light grey and dark grey limestone (Upper Jurassic), 12. Light grey and dark grey limestone (Upper Jurassic), 13. Dark grey grained dolomite and limestones (Upper Jurassic), 14. Suppositional underground water flow, 15. Trap-shooting ground, 16. Quarry, 17. Local road, 18. The Sviščaki tourist centre, 19. Suggested water-protection area, 20. Karst spring.

#### FIZIKALNO KEMIJSKE LASTNOSTI IN MIKROBIOLOŠKA KAKOVOST VODE V IZVIRIH

Meritve fizikalno kemijske in mikrobiološke kakovosti kraškega izvira Bistrica za potrebe upravljavca isto-

imenskega zajetja pitne vode opravlja v okviru rednih in občasnih analiz Zavod za zdravstveno varstvo Koper (v nadaljevanju ZZV Koper). Nekaj podatkov o temperaturi vode v izviroh Bistrica, Sušec in Kovačevce je objavil tudi Boegan (1938). Za natančnejšo podobo o fizikalno ke-



mijskih in mikrobioloških lastnostih obravnavanih kraških izvirov bi bilo treba opraviti sistematične meritve.

Redne mesečne meritve fizikalno-kemijskih parametrov surove vode na zajetju kraškega izvira Bistrica, opravljene v letih od 2000 do 2002, kažejo na letno gibanje med 8,7 in 10,8 °C. Maloštevilni podatki za občasna izvira Sušec in Kovačevac kažejo, da sta izvira nekoliko hladnejša, saj najnižja izmerjena vrednost znaša 7 °C (Boegan, 1938). Rezultati meritev SEP vode v zajetju za isto opazovano obdobje se sučejo med 324 in 388 µS/cm, pH vrednosti med 7,12 in 7,77. Enkratna meritev trdote vode kaže, da je karbonatna trdota vode v zajetju 10,9 °NT, nekarbonatna trdota pa samo 0,6 °NT, kar se ujema z geološko zgradbo zaledja izvirov. V litru vode je raztopljeno 55 mg kalcijevih in 10 mg magnezijevih kationov (ZZV Maribor, 1999; ZZV Koper, 2000-2002).

% Zdravstveno neustreznih vzorcev pitne vode

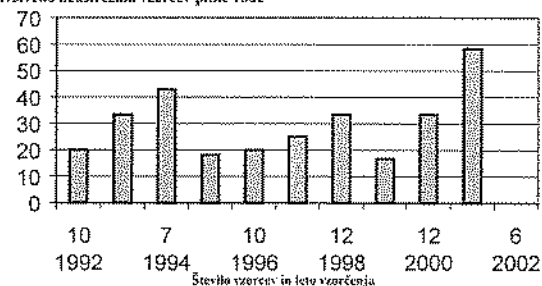

\* V letu 2002 so zajete analize do vključno meseca julija.

**Sl. 8: Rezultati mikrobioloških analiz kraškega izvira Bistrica (Kovačič, 2001a; ZZV Koper, 2000-2002).**

**Fig. 8: The results of microbiological analyses of water samples taken from the Bistrica karst spring (Kovačič, 2001a; ZZV Koper, 2000-2002).**

#### OGROŽENOST IN VAROVANJE IZVIROV

Mikrobiološke lastnosti izvira Bistrica kažejo, da je voda večinoma primerna za pitje tudi brez predhodnega čiščenja, medtem ko po fizikalno-kemijskih parametrih voda popolnoma ustreza kriterijem o zdravstveni ustreznosti pitne vode (Sl. 8). Podobno kot večina drugih kraških izvirov je tudi voda v zajetju Bistrica občasno okužena z mikroorganizmi, zato je za kakovost pitne vode poskrbljeno s stalnim razkuževanjem na črpališču v neposredni bližini zajetja.

Zaledje izvirov označuje razvit globoki kras Snežniške planote z dobro prepustnostjo. Zaradi pretakanja vode po razpokah in kanalih so pretoki kraške podzemne vode v primerjavi z nekraškimi podzemskimi zelo hitri in skrajšajo čas že tako omejenega biokemijskega čiščenja, kar slabša njeno kakovost. Zaradi dobre prevodnosti v kraških vodonosnikih skorajda ne prihaja do mehničnega čiščenja, zato kraški izviri pogosto kalijo. Z vidika varovanja vode v izvirov je pozitivno

dejstvo, da zaledje oblikujejo prostrani in neposeljeni gozdovi Snežniške planote, tako da je to zaradi reliefnih, podnebnih in geoloških značilnosti za kmetijsko rabo skrajno neprimerno območje. Kljub temu so izviri ogroženi zaradi gradbeniške, športne, turistične in gozdarske dejavnosti ter z njimi povezanega prometa v njihovem ožjem in širšem zaledju (Sl. 7) (Kovačič, 2001b). Ocene kažejo, da je koncentracija svinec v prsti, ki ga vsebujejo šibni naboji pušk, na aktivni površini športnega strelišča na Črnih njivah (to leži približno 700 m od izvira Bistrica na območju nekdanjega vojaškega strelišča) zelo velika. Za dosego mejne vrednosti letnega vnosa omenjene kovine (2,5 kg/ha), ki jo predpisuje Uredba o vnosu nevarnih snovi in rastlinskih gnojil v tla iz leta 1996 (UL RS, 1996), bi zadostovalo 150 izstreljenih nabojev letno. Dosedanje fizikalno-kemijske analize kakovosti vode iz izvira Bistrica kažejo, da je koncentracija svinec v vodi v mejah dovoljenih vrednosti, četudi strelišče obratuje že dve desetletji. Razširjene meritve fizikalno-kemijskih lastnosti vode, ki jih na izvirov Bistrica praviloma opravljajo dvakrat letno, kažejo na porast vsebnosti te kovine v vodi. Junija 2002 je koncentracija svinec v vodi dosegla do 4 µg/l (mejna dovoljena vrednost za pitno vodo znaša 10 µg/l) (ZZV Koper, 2000-2002). Za zagotavljanje kakovostne pitne vode v kraškem izvirov Bistrica in v sosednjih izvirov je potrebna preselitev športnega strelišča zunaj napajalnega območja izvirov ter sanacija s svincem onesnažene površine in prsti na strelišču.

Turistično naselje Sviščaki (90 počitniških hiš) leži globoko v osrčju Snežniške planote, daleč stran od obravnavanih izvirov. Kljub temu ga avtorji strokovnih podlag za zavarovanje kraškega izvira Bistrice (Juren & Krivic, 1989; Petauer *et al.*, 2002) uvrščajo v vplivno vodovarstveno območje. Varstvo kraške podtalnice bi morali zagotavljati z graditvijo neprepustnih greznic, ki jih večina objektov nima.

Promet v povezavi z gozdarsko, turistično in gradbeniško dejavnostjo pomeni veliko grožnjo za zajetje, saj v njegovi neposredni bližini poteka lokalna cesta Ilirska Bistrica – Sviščaki, ki ni urejena tako, da meteorne vode s cestišča ne bi odtekale neposredno v vodonosnik.

V hidrografskem zaledju izvirov sta dva kamnoloma. Spodnji, ki leži 200 m nad vodnim zajetjem, danes ne obratuje več. Danes v njem meljejo apnenec, ki ga dovažajo iz zgornjega kamnoloma. Kamnolom je danes nekakšno parkirišče za številne zavržene avtomobile ter delovno mehanizacijo in tovornjake, v njem pa se skrajno neprimerno skladišči nafta za pogon težke mehanizacije. Do pred kratkim je kamnolom rabil kot odlagališče odpadnega gradbenega materiala za širše območje Ilirske Bistrice. Pri kamnolomih je treba biti posebno previden pri vplivih na neposredni kraški odtok, kar pomeni, da je treba skrbno paziti, da se preprečijo kakršni koli izlivi nafte in olj ter drugih strupenih ali škodljivih snovi, saj bi vsakršno njihovo izlitje lahko

daljnosežno vplivalo na kvaliteto kraške talne vode (Šebela, 1997). Kemijske analize vode iz zajetja kažejo na občasno povečanje vsebnosti mineralnih olj v pitni vodi, ki skoraj dosegajo prag mejnih dovoljenih vrednosti (ZZV Koper, 2000-2002) in so dejansko lahko posledica neurejenih razmer pri gospodarjenju v kamnolomih. Sanacija spodnjega kamnoloma je nujna za dolgoročno zagotavljanje kakovostne pitne vode, obratovanje zgornjega kamnoloma pa je treba sanirati do stopnje, ko ne bo več ogrožalo kraške podtalnice (Kovačič, 2001a).

Kraški izvirov Bistrica je zavarovan z Odlokom o določitvi varstvenih pasov in ukrepov za zavarovanje vodnih virov (PN Uradne objave, 39/1985), vendar so njegovi varstveni pasovi izdelani le na osnovi razdalj od zajetja, režim varovanja pa je v primerjavi z novjšimi metodologijami o zavarovanju podzemne pitne vode preblago in slabo definiran in se v glavnem ne uresničuje. Na podlagi hidrogeoloških raziskav zaledja so bile v letu 1989 (Juren & Krivic, 1989) in 2002 (Petauer *et al.*, 2002) izdelane strokovne podlage za zavarovanje kraškega izvira Bistrica. Nobena od predlaganih ni bila sprejeta z občinskim odlokom, kajti z novim Zakonom o vodah iz leta 2002 (UL RS, 2002) je določevanje vodovarstvenih območij pitne vode prešlo iz rok lokalnih oblasti v pristojnost države. Tako ostaja regionalno pomemben vir pitne vode praktično nezavarovan (Kovačič, 2001a).

#### ZAKLJUČEK

Stalni in občasni kraški izviri v okolici Ilirske Bistrice so del enotnega hidrološkega sistema. Hidrološko za-

ledje izvirov, ki obsega približno 50 km<sup>2</sup>, sestavlja neposeljena kraška planota Snežnik. Izviri se napajajo izključno kraško z avtohtono padavinsko vodo, površinskih tekočih voda in ponikalnic v zaledju ni. Posebnost izvirov je njihova razporeditev vzdolž naravnega roba ob zahodnem vznožju apniške Snežniške planote na eocenski fliš doline Reke. Izviri značilno reagirajo na hidrološke razmere v zaledju s hitrim naraščanjem pretoka ter hitrim upadanjem, najprej v najvišje ležečih izvirov.

Fizikalno-kemijske in mikrobiološke analize pitne vode iz kraškega izvira Bistrica, ki je zajet za vodooskrbo širšega območja, kažejo, da je voda precej kakovostna. V nenaseljenem gozdnem kraškem zaledju pa kljub temu najdemo nekaj resnih potencialnih in dejanskih onesnaževalcev kraške podtalnice. Zajetje pitne vode je sicer zavarovano, vendar so varstveni ukrepi slabo določeni in jih ne uresničujejo.

Za boljše razumevanje hidroloških razmer je treba opraviti še vrsto nadaljnjih raziskav, analiz ter meritev. Pridobiti bi morali kakovostne in med posameznimi izvirov primerljive podatke o fizikalno-kemijskih lastnostih vode. Izpeljati bi morali natančna merjenja pretokov posameznih izvirov skozi primerljivo časovno obdobje ter preučiti hitrost odzivanja izvirov na padavinske dogodke v zaledju. Z zanesljivimi podatki o pretokih bi s pomočjo izračuna vodne bilance lahko približno določili velikost hidrografskega zaledja izvirov, katerega meje bi morali potrditi s sledilnimi poskusi. Z njimi bi pridobili tudi podatke o hitrostih in smerih pretakanja kraške vode v zaledju, kar bi pripeljalo do boljšega razumevanja hidrološkega sistema izvirov Bistrice, omogočilo pa bi tudi jasnejšo opredelitev vodovarstvenih območij.

#### BISTRICA KARST SPRINGS (SW SLOVENIA)

Gregor KOVAČIČ

Faculty for Humanities Koper, University of Primorska, SI-6000 Koper, Glagoljaška 8  
E-mail: gregor.kovacic@fhs-kp.si

#### SUMMARY

The Bistrica karst springs are distributed along the western foot of the Snežnik karst plateau (NW Dinarids) at the junction with the impermeable Eocene flysch of the Reka valley. Tectonically, the Snežnik karst plateau is part of the Snežnik thrust sheet, which is in its western part over-thrust to flysch layers. Deeply karstified Cretaceous and Jurassic limestones, dolomites and dolomite-limestone breccias prevail. Autochthonous precipitation water runs towards the karst springs situated in the margins of the plateau. The catchment area of the Bistrica springs stretches over a small part of the plateau. The estimated area is 50 km<sup>2</sup>.

Permanent and periodical karst springs are situated at an altitude of 420 to 470 m. During the dry period, the discharge of three of the springs reaches a total of only about 0.140 m<sup>3</sup>/s at the gauging station. After heavy rains, their discharge exceeds 36 m<sup>3</sup>/s. The ratio between low, medium and high discharges is 1 : 36 : 830, but if the quantity of water tapped for water supply is calculated, this value is 1 : 12 : 254. It has been estimated that the mean annual discharge from the springs equals 1.85 m<sup>3</sup>/s. The time distribution of the mean monthly discharges shows that two annual maximums occur, the first in November and the second in April, while the lowest mean discharges

occur in July and August and the second minimum in February. The second maximum in April is the result of snow melting during the spring months. There are not many data available on the physical and chemical characteristics of the springs, but there are some on the Bistrice karst spring.

Due to its climate, geomorphologic and geological conditions, the Snežnik plateau is somewhat inconvenient for agriculture and, for this very reason, uninhabited. In spite of this, the karst springs are endangered by pollution from the construction, sports, tourism and forestry activities taking place in their more or less immediate vicinity as well as by traffic associated with these particular activities. The Bistrice karst spring is the most abundant amongst all the springs mentioned above and is therefore tapped for water supply. The spring is protected, but the water-protecting measures to be taken are inappropriately defined and have not been carried out so far. One of the most important drinking water resources in SW Slovenia thus remains practically unprotected.

Further investigations, analyses and measurements are needed in order to provide necessary information about the hydrological conditions in the area, including measurements of the physical and chemical characteristics of the springs. To determine the catchment area and consequently appropriate water protecting areas of the springs, particularly the Bistrice karst spring, accurate measurements of discharges as well as some tracing tests should be carried out in the hinterland.

**Key words:** Bistrice karst spring, karst hydrology, Snežnik plateau, SW Slovenia

#### LITERATURA

- Boegan, E. (1938):** Il Timavo. Studio sull'idrografia carsica subarea e sotterranea. Memorie dell'Istituto Italiano di speleologia. Serie geologica e geofisica, II, Trieste, 134 pp.
- Brečko-Gruber, V. & D. Plut (2001):** Kakovost virov pitne vode v Sloveniji. Ujma, 14-15, 238-244.
- Brumen, S., S. Lapajne, E. Vončina, L. Osvald, M. Babič & M. Medved (1991):** Kataster kakovosti vodnih virov 1990. Zavod za zdravstveno varstvo Maribor, Inštitut za varstvo okolja, Maribor, p. 17-24.
- Geodetski zavod SRS, Oddelek za kartografijo (1981):** Pregledna karta občine Ilirska Bistrica, Ljubljana.
- Habič, P. (1984):** Vodna gladina v Notranjskem in Primorskem krasu Slovenije. Acta carsologica, 13, 37-78.
- Hidrometeorološki zavod RS (1999):** MOP, Agencija RS za okolje. Interni podatki.
- Juren, A. & P. Krivic (1989):** Strokovne podlage za zavarovanje vodnih virov in vodnih zalog kot osnova za sprejem odloka za zaščito vodnega vira Bistrice (Ilirska Bistrica). Geološki zavod Ljubljana, TOZD geologija, geotehnika in geofizika, Ljubljana, 8 str.
- Kolbezen, M. & J. Pristov (1998):** Površinski vodotoki in vodna bilanca Slovenije. MOP-Hidrometeorološki zavod Republike Slovenije, Ljubljana, 98 str.
- Kovačič, G. (2001a):** Okoljevarstvena problematika vodooskrbnih območij občine Ilirska Bistrica. Diplomsko delo. Univerza v Ljubljani, Filozofska fakulteta, Ljubljana, 89 str.
- Kovačič, G. (2001b):** Pokrajinska ogroženost in ukrepi za zaščito kraškega izvira Bistrice. Annales Ser. hist. nat., 11(1), 93-104.
- Odlok o določitvi varstvenih pasov in ukrepov za zavarovanje vodnih virov, občina Ilirska Bistrica (1985):** Primorske novice, Uradne objave, 39 (29), Koper, str. 118-119.
- Petauer, D., A. Juren, P. Štucin & S. Hovar (2002):** Strokovne podlage za zaščito vodnih virov občine Ilirska Bistrica. GEOOKO & GeoSi, Ljubljana, 66 str.
- Petrič, M. (2002):** Characteristics of recharge-discharge relations in karst aquifer. Založba ZRC, Ljubljana, 150 str.
- Placer, L. (1981):** Geološka zgradba jugozahodne Slovenije. Geologija, 24(1), 27-60.
- Pleničar, M. (1968):** Na Snežnik z očmi geologa. Planinski vestnik, 68(6), 351-353.
- Rojšek, D. (1987):** Fizičnogeografske značilnosti in naravne znamenitosti porečja Notranjske Reke. Varstvo narave, 13, 5-24.
- Rojšek, D. (1996):** Velika voda – Reka – kraška reka. Acta carsologica, 25, 193-206.
- Šebela, S. (1997):** Kamnolomi. Kras, 21, 54-55.
- Šifrer, M. (1959):** Obseg pleistocenske poledenitve na Notranjskem Snežniku. Geografski zbornik, 5, 27-83.
- Šikič, D., M. Pleničar & M. Šparica (1972):** Osnovna geološka karta SFRJ 1:100.000, list Ilirska Bistrica. Zvezni geološki zavod Beograd, Beograd.
- Šikič, D. & M. Pleničar (1975):** Osnovna geološka karta Jugoslavije. Tolmač za list Ilirska Bistrica. Zvezni geološki zavod Beograd, Beograd, 51 str.
- Uradni list RS (1996):** Uredba o vnosu nevarnih snovi in rastlinskih hranil v tla. UL RS, št. 68, str. 5769-5737.
- Uradni list RS (2002):** Zakon o vodah. UL RS, št. 67, str. 7648-7680.
- Zavod za zdravstveno varstvo Koper (2000-2002):** Poročila o preskusu pitne vode. Tipkana poročila, Koper.
- Zavod za zdravstveno varstvo Maribor (1999):** Monitoring kakovosti izvirov v letu 1998. Inštitut za varstvo okolja-tehnološki center, Maribor, 21-42.
- Zupančič, B. (1995):** Klimatogeografija Slovenije, Padavine 1961-1990. MOP, Hidrometeorološki zavod Republike Slovenije, Ljubljana, 366 str.

## DELO NAŠIH ZAVODOV IN DRUŠTEV

ATTIVITÀ DEI NOSTRI ISTITUTI E DELLE NOSTRE SOCIETÀ

ACTIVITIES BY OUR INSTITUTIONS AND ASSOCIATIONS

### OCENE IN POROČILA

RECENSIONI E RELAZIONI

REVIEWS AND REPORTS

DELO NAŠIH ZAVODOV IN DRUŠTEV  
 ATTIVITÀ DEI NOSTRI ISTITUTI E DELLE  
 NOSTRE SOCIETÀ  
 ACTIVITIES BY OUR INSTITUTIONS  
 AND ASSOCIATIONS

MEDNARODNA DELAVNICA  
 "EKOREMEDIACIJE V CELOSTNEM UPRAVLJANJU Z  
 VODAMI V SREDOZEMLJU"

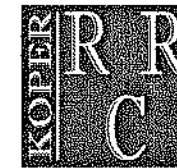

**Regionalni razvojni center Koper**  
**Centro regionale di sviluppo Capodistria**  
**RRA Južna Primorska**

V Fiesi je 29. in 30. oktobra 2002 potekala mednarodna delavnica z naslovom "Ekoremediacije v celostnem gospodarjenju z vodami v Sredozemlju". Z izrazom ekoremediacija označujemo uporabo naravnih in sonaravnih sistemov in procesov za zaščito in obnovo okolja. Dogodka v Fiesi so se udeležili predstavniki občin slovenske Istre, Ministrstva RS za okolje, prostor in energijo, lokalnih komunalnih podjetij, Zavoda RS za varstvo narave, lokalnega prebivalstva ter strokovnjaki z Vodnogospodarskega inštituta iz Ljubljane, podjetja Limnos kot tudi predstavniki METAP in GWP ter iz Republike Hrvaške: iz Istrske županije, univerze iz Zagreba in Hrvatskih vod. V okviru uresničevanja regionalnega razvojnega programa za Južno Primorsko je delavnico organizirala Regionalna razvojna agencija iz Kopra, finančno pa sta jo omogočila Mediteranski program za okolje (METAP) in Global Water Partnership (GPW).

Ob koncu delavnice, ki je bila osredotočena na reko Dragonjo, so udeleženci oblikovali naslednja priporočila:

**Izhajajoč iz dejstva,**

- da je povodje reke Dragonje območje izjemnih naravnih vrednot in biotske raznovrstnosti, krajine, hidroloških in hidromorfoloških procesov ter mnogih,

pogosto nasprotujočih si razvojnih pobud, kar zahteva posebno skrben pristop h gospodarjenju z območjem;

**ter ugotovitve**

- da so bile za povodje Dragonje že doslej narejene ali se izdelujejo mnoge zelo kvalitetne strokovne podlage (vodnogospodarske osnove, inventarizacija naravnih vrednot in druge);

**udeleženci delavnice priporočamo:**

- da se na državni, regionalni in občinski ravni oživijo aktivnosti za zagotavljanje celovitosti vodnega režima, za zagotavljanje varovanja naravnih vrednot in ohranjanja biotske raznovrstnosti povodja ter za pripravo z njimi usklajenih prostorskih planskih in izvedbenih aktov;

- vzpostaviti je treba integralen pristop k planiranju in upravljanju s povodjem Dragonje, ki bo povezoval ključne vidike razvoja območja, kot so prostorsko planiranje in urejanje, razvoj podeželja, kmetijstva in turizma, ohranjanje narave, varstvo in upravljanje z vodami, vzpostavitev infrastrukture, predvsem tiste za varstvo okolja;

- organizacijska struktura za urejanje območja naj poveže vse ključne partnerje, predvsem Ministrstvo za okolje, prostor in energijo, Ministrstvo za kmetijstvo, prehrano in gozdarstvo, kmetijsko svetovalno službo, Zavod RS za varstvo narave; občine Koper, Izolo in Piran, gospodarske akterje, kot so: upravljalec Sečoveljskih solin – podjetje Soline in Vinakoper; Regionalno razvojno agencijo, Ribiško družino Koper, predstavnike prebivalcev vasi v porečju; strokovne institucije, predstavnike iz R Hrvaške, ter druge zainteresirane partnerje;

- za ciljne skupine sodelujočih v celostnem upravljanju z vodami naj se pripravijo ustrezni informativni tečajji, pri čemer je program delavnice lahko dobra osnova za pripravo programov;

- v okviru meddržavne komisije za vode med R Slovenijo in R Hrvaško naj se izboljša pretok informacij z obeh strani meje do lokalnih ravni;

- prioriteto je treba pristopiti k problematiki čiščenja odpadnih voda, predvsem sanaciji onesnaževanja iz razpršenih virov (posebno pereč je problem mikrobiološke onesnaženosti) ob istočasnem varstvu vodnih količin in ohranjanju dobrega ekološkega stanja;

- pri urejanju območja naj se nakloni posebna pozornost sonaravnim ekoremediacijskim pristopom k razvoju dejavnosti in sonaravnim tehnologijam, tako da bi območje reke Dragonje postalo pilotni primer tovrstnega trajnostnega urejanja (tj. pristopa, ki enakovredno upošteva družbene, gospodarske in okoljske vidike). Uspešno izvedeni primeri naj se promovirajo v regiji in v celotni državi pa tudi širše - preko struktur Mediteranskega akcijskega programa (MAP) in METAP;

- v ta namen naj se prioriteto uredijo vzorčni objekti čiščenja odpadnih voda z ekoremediacijskim načinom za tipične primere onesnaževanja: razpršena poselitve,



turistični objekti, deponija odpadkov, oljarna; ti objekti naj se skupaj s tipičnimi naravnimi procesi samo-očiščevanja v dolini Dragonje predstavijo ob ekoremediacijski tematski poti in ob ustreznem informativnem gradivu (decembra 2002 je bila brošura tudi pripravljena in je zainteresiranim na voljo na Limnosu, kjer je tudi sedež GWP Slovenija).

- zaradi promocije in uveljavljanja v širšem prostoru Mediterana naj se nekatere od teh aktivnosti opravijo v okviru projekta MAP CAMP Slovenija.

Slavko Mezek  
Bogdan Macarol  
Mitja Bricelj

#### "OHRANIMO ŽELVO V SLOVENSKEM MORJU"

Morska želva kareta (*Caretta caretta*) je nedvomno ena najbolj ogroženih vrst Sredozemlja in razmeroma reden gost v našem morju, kar slovenski in tuji javnosti sicer ni znano. V slovenskem morju se redno pojavlja med aprilom in novembrom. Slovensko morje je pomembno predvsem kot prehranjevalno območje za mlade karete. Te se namreč v prvem obdobju hranijo s pelaškimi organizmi, zatem pa izključno z organizmi, ki živijo na morskem dnu. Plitvost slovenskega morja omogoča to spremembo v prehranjevalnih navadah tudi zelo mladim želvam in je zato za njihovo preživetje velikega pomena. Z ohlajanjem severnega Jadrana konec jeseni se želve selijo južneje, proti Kvarnerju in srednji Dalmaciji, del populacije pa verjetno celo zapusti Jadransko morje. Kareta je v Sloveniji zaščiten z *Uredbo o zavarovanju ogroženih živalskih vrst*, v habitatni direktivi EU je opredeljena kot prioritarna vrsta, uvrščena pa je tudi na seznam ogroženih vrst v okviru Barcelonske konvencije oziroma Protokola o posebej zavarovanih območjih in biotski raznovrstnosti v Sredozemlju.

Države podpisnice Barcelonske konvencije so zaradi njihove ogroženosti že leta 1989 sprejele akcijski načrt za varovanje sredozemskih morskih želv in s tem tudi karete (*Action Plan for the Conservation of Mediterranean Marine Turtles*). Načrt, ki je bil dopolnjen leta 1999, predvideva številne aktivnosti, ki jih v grobem lahko strnemo v naslednjih točkah:

- zakonsko varovanje morskih želv in upravljanje zavarovanih območij za njihovo varovanje,
- ohranjanje in upravljanje habitatov, pomembnih za ohranjanje morskih želv (območja gnezdenja, prehranjevanja, prezimovanja idr.),
- zmanjševanje smrtnosti, povzročene z ribolovnimi sredstvi; in preprečevanje uporabe morskih želv za prehrano oz. kot surovino (roževina),



Foto: T. Makovec

- vzpostavitev sredozemske mreže zavarovanih območij za morske želve,
- ozaveščanje in vzgoja,
- raziskovalno delo in monitoring,
- koordinacija aktivnosti.

Akcijski načrt predvideva tudi oblikovanje nacionalnih akcijskih načrtov, v katerih si posamezne države podpisnice postavijo osnovo za ustrezno dolgoročno načrtovanje aktivnosti v zvezi z varovanjem morskih želv.

Republika Slovenija uresničuje omenjeni akcijski načrt, prek piranske območne enote Zavoda RS za varstvo narave in piranskega akvarija Srednje pomorske šole v Portorožu, že od leta 1995, in sicer v delu, ki se nanaša na zbiranje podatkov o pojavljanju karete in označevanju ulovljenih in zatem izpuščenih osebkov. V zadnjih letih je bilo označenih in ponovno izpuščenih približno trideset želv, vendar pa so se navedene aktivnosti nanašale v pretežni meri na piranski del morja in ribičev. Da bi k sodelovanju pri obveščanju o ulovu pritegnili vse slovenske morske ribiče in tudi druge uporabnike morja, je Zavod RS za varstvo narave, Območna enota Piran, v sodelovanju z Ministrstvom za

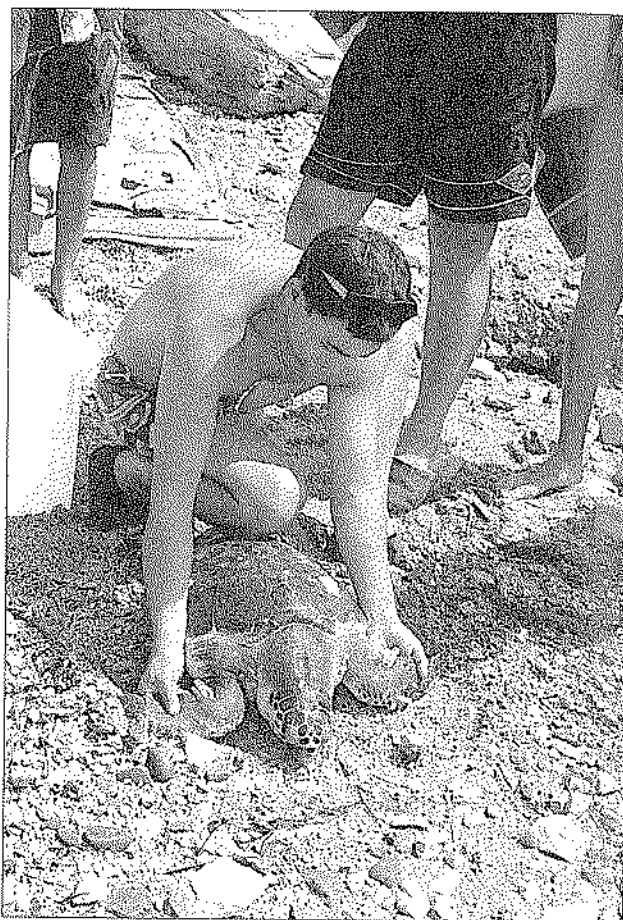
okolje, prostor in energijo pripravil akcijo "Ohranimo želvo v slovenskem morju". Akcija, ki jo operativno vodi piranska enota Zavoda RS za varstvo narave, v njej pa sodelujeta tudi piranski akvarij in Morska biološka postaja Piran (Nacionalni inštitut za biologijo), je del partnerskega dogovora ministrstva in družbe Petrol pri ohranjanju in trajnostni rabi slovenskih voda.

Za leto 2003 je bil tako pripravljen program aktivnosti, namenjenih v prvi vrsti obveščanju in ozaveščanju vseh slovenskih ribičev in drugih uporabnikov slovenskega morskog prostora ter širše javnosti, zatem boljši organizaciji zbiranja podatkov in, nenazadnje, sprejetju uradnega nacionalnega akcijskega načrta varovanja morskih želv na osnovi pridobljenih podatkov. Z naštetim naj bi uresničili predvsem tri poglobljene cilje projekta, in sicer: zmanjšali naključni ulov in pogin želv, pridobili več podatkov o ulovljenih želvah in prispevali k boljšemu poznavanju njihovih migracijskih poti, kritičnih habitatov, življenjskega ciklusa in biologije vrste nasploh. V skladu z navedenim sodeluje v projektu posredno tudi raziskovalec Hrvaškega prirodoslovnega muzeja iz Zagreba Bojan Lazar, nosilec programa *Raziskovanje in zaščita želv v Jadranu*. Sedanji rezultati analize naključnega ulova, izsledki označenih osebkov in preliminarni analize prehrane kažejo, da je severni Jadran pomemben habitat te vrste v Mediteranu.

Ministrstvo za okolje, prostor in energijo ter družba Petrol sta ob začetku akcije poskrbela za tiskanje priložnostnih plakatov ter informativnih zgibank za ribiče in druge uporabnike morja. Informacije o akciji so objavljene tudi na spletnih straneh ministrstva in družbe Petrol. Akvarij Piran Srednje pomorske šole iz Portoroža skrbi za sodelovanje z ribiči, za prevzemanje ulovljenih želv ter njihovo označevanje in izpustitev. Oblikovanje baze podatkov in ustrezna analiza slednjih pa je zupana Morski biološki postaji. Podatki bodo po zaključku akcije posredovani Regionalnemu centru za zavarovana območja v Tunisu, koordinatorju Akcijskega načrta za varovanje sredozemskih morskih želv. Ob vsem navedenem pa družba Petrol za sodelovanje v akciji vsakemu, ki prinese želvo, podari tudi simbolično nagrado – priložnostno majico in 50 litrov goriva.



Foto: T. Makovec

Na osnovi poročanja medijev in neformalnih razgovorov s predstavniki lokalnih skupnosti, različnih društev in s posamezniki lahko sklepamo, da so načrtovane aktivnosti naletele na ugoden odziv tako pri ribičih kakor tudi v širši javnosti. Pri tem velja posebej poudariti sodelovanje družbe Petrol oziroma njeno pripravljenost, da prevzame dejavno vlogo pri uresničevanju načel trajnostnega razvoja, katerih neločljivi del sta tudi skrb in zavzemanje za varovanje ogroženih vrst in ohranjanje biotske raznovrstnosti. V zgibanko smo zapisali - Želva išče prijatelje. Tokrat jih ni našla le v uradnih in neuradnih naravovarstvenikih, v piranskem akvariju ter ribičih, pač pa tudi v družbi Petrol.

Robert Turk  
Valter Žiža  
Tihomir Makovec

OCENE IN POROČILA  
RECENSIONI E RELAZIONI  
REVIEWS AND REPORTS

Boris Sket, Matija Gogala, Valika Kuštor (ur.) 2003:  
ŽIVALSTVO SLOVENIJE. Tehniška založba Slovenije,  
Ljubljana, 2003, 664 strani.

Spomladi leta 2003 je na knjižne police prišla obsežna monografija *Živalstvo Slovenije*. Knjiga je napisana na 664 straneh velikega formata. Uredili so jo Boris Sket, Matija Gogala in Valika Kuštor, izdala pa Tehniška založba Slovenije. Besedilo je prispevalo 40 avtorjev, vrhunskih domačih strokovnjakov na svojih področjih. Bogati slikovni material je delo 46 fotografov in 16 risarjev. Knjiga obravnava 88 strokovnih poglavij, vsako poglavje predstavlja neko širšo ali ožjo taksonomsko skupino živali na območju, za katero radi pravimo, da je po številu vrst eno bogatejših v Evropi.

Osrednji del knjige je razdeljen na tri sklope: sklop nevretenčarjev, od katerih so z uredniškim posegom kot poseben sklop ločene žuželke, in sklop vretenčarjev. Vsak sklop ima svojo barvo, tako da jih ločimo že od daleč. S svojo barvo so označena tudi uvodna poglavja. Tu izvemo osnovne podatke o spremembah živalstva na ozemlju Slovenije od obdobja kambrija naprej ter o vlogi, ki jo je pri zoodiverziteti imel in jo še ima človek. Spoznamo osnovne zakonitosti sistematskega razvrščanja živih bitij in nekaj dejstev o ogroženosti in varovanju živali pri nas. Ob koncu je v treh tabelah pestrost naših živali postavljena ob bok svetovni in pestrosti dveh sosednjih držav.

Prvi strokovni sklop, ki so ga uredniki poimenovali Nižji nevretenčarji, obravnava 43 taksonomskih skupin (nekako na nivoju razredov), med katerimi najdemo pri nas slabo poznane čaškarje, kinorinhe, žive niti, počasnike ipd., pa tudi bolj in dobro poznane spužve, pijavke, rake, če imenujem le nekatere. Količina napisanega besedila pri posamezni skupini je odvisna od števila poznanih vrst, predvsem pa od poznavanja skupine. Drugi sklop sestavlja, kot že rečeno, ena sama skupina, žuželke, ki pa so zaradi preglednosti razdeljene v 36 nižjih (nekako na nivoju redov) taksonomskih skupin. Glede na razmerje med številom vrst žuželk in številom vrst vseh drugih skupin nevretenčarjev je delitev kar smiselna. Zadnji sklop opisuje vretenčarje, ki so razdeljeni v devet nižjih taksonomskih skupin. Čeprav cenitve pravijo, da je vseh vretenčarskih vrst nekaj desetkrat manj kakor žuželčnih, so v knjigi predstavljene na le okoli pol manj straneh kot žuželke. To je pač skupina živali, ki jo najbolj poznamo in o kateri lahko veliko tudi napišemo. Po drugi plati pa je tudi očitno, da je število strani za posamezen sklop v veliki meri posledica odločitve, da knjiga ne bo znanstvena, ampak

poljudno-strokovna publikacija s tudi ekonomskimi ambicijami. Pri knjigah takšnega kova pa je jasno, ktere živalske skupine privabijo največ kupcev.

Vsako poglavje večinoma predstavlja en živalski razred ali red. Začne se s kratko oznako skupine in značilnostmi telesne zgradbe ter ploditve, kjer so izpostavljene le osnovne značilnosti, ki jih bo z lahkoto razumel vsakdo, ne glede na izobrazbo. Bralec v pomoč so tudi številne skice. V odstavku o ekologiji dobimo osnovne podatke o tem, kje in kako živijo predstavniki skupine. Sledi odstavek o raziskanosti, kjer so predstavljeni posamezniki in institucije, ki so se in se še vedno ukvarjajo s skupino pri nas. Zelo primerna je tudi ocena o številu pri nas že poznanih vrst in o predvidevanjih, koliko jih lahko še pričakujemo. Že res, da so včasih napisane "prek palca" (natančnost ocene se močno razlikuje od skupine do skupine), a to je trenutno največ in najboljšo, kar zmoremo. Ob koncu vsakega poglavja sledi še predstavitev vrst. Opisane niso vse, ki pri nas živijo, pa vendar dovolj, da lahko vsakdo dobi približen občutek o pestrosti živalstva na našem ozemlju.

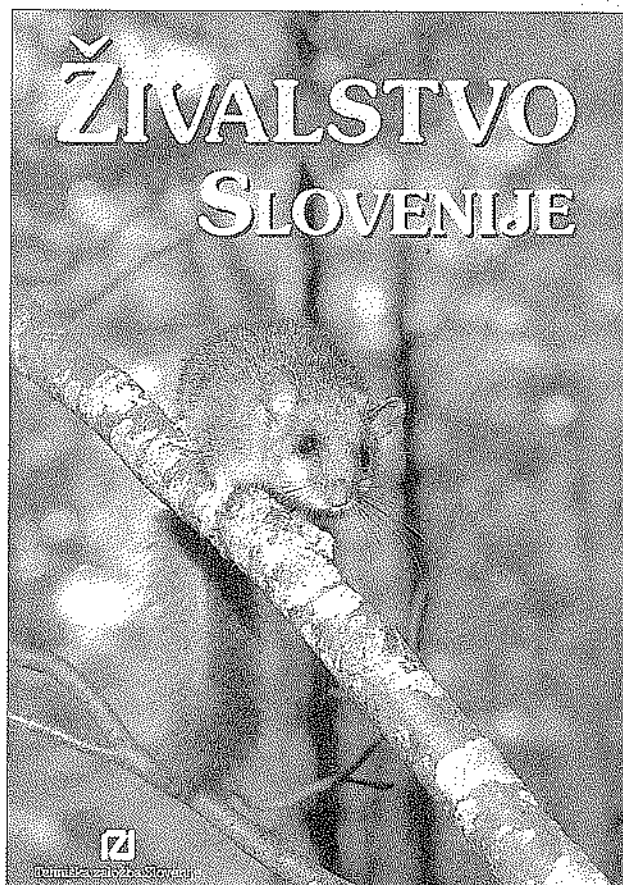

Uredniki so k nastajanju knjige "Živalstvo Slovenije" pritegnili številne strokovnjake, ki so v besedila vložili ogromno znanja in dela. Mirno lahko zapišem, da je

kljub nekaterim pomanjkljivostim in visoki ceni vredna nakupa – če vas seveda živali zanimajo. Tolikokrat opovano pestrost slovenske favne nam prvič na tako celovit način polaga na dlan, za kar gre avtorjem, urednikom in navsezadnje tudi založbi vse priznanje. Res pa je tudi, da o skupini, ki vam je toliko pri srcu, da ste o njej že prebrali kakšno drugo knjigo, kaj dosti novega ne boste izvedeli. Sicer pa je to usoda vseh poljudno-strokovnih del, pri knjigi *Živalstvo Slovenije* pa vam kljub temu ostane še obilo novega na straneh tistih skupin, ki jih ne poznate.

Davorin Tome

Andrej Gogala: KAMEN, VODA, SONCE IN VETER.  
NARAVA KRASA IN SLOVENSKE ISTRE. Prirodoslovni  
muzej Slovenije, Ljubljana, 2003, 176 strani.

"*Veter, pesek in zvezde*" izpod peresa A. de Saint Exuperyja ... ali pa "*morje, sonce in veter*", kot je zapisal umetnostni kritik Kastelic h katalogu Pfeiferjeve fotografске razstave o Sečoveljskih solinah. Iste magične besede, ključne besede, kadar hočemo opis narave strniti, ga narediti vseobsegajočega in še osebnega hkrati: naslov Gogalove knjige je zato "v stilu" omenjenih dveh, in vse obljubljeno v naslovu bralec najde tudi v knjigi.

Le redko je v eni osebi združen odličen fotograf, široko razgledan biolog, specialist entomolog in občudovalec pokrajine. Prav to je dr. Andrej Gogala, avtor knjige *Kamen, voda, sonce in veter*, ki je več kot fotomonografija, nekje med znanstvenim tekstom in esejem. V prologu nas avtor uvede v območje in temo, ki jo v knjigi obdela, nato pa v devetih poglavjih opiše posamezne pokrajinske enote od Visokega krasa do Sečoveljskih solin.

Najbolj se avtor posveti kraškimi pokrajinam, njihovi neživi in živi naravi. Vsak mikro-svet je zgodba, ki ima rep in glavo, to je knjiga, v kateri ob lepih fotografijah ni neoprijemljivega leporečja in "nakladanja". To je v slovenskem tisku precej v navadi pri opremljanju lepih fotografij: zelo pogosto oko vidi, razum pa ne dojame... Pri Gogalovi knjigi sta obe komponenti povsem enakovredno zastopani. Fotografije imajo za seboj biološko zgodbo, ki je načeta v likovni in dokončana v pisni obliki. Organizmi na fotografijah so določeni do vrste, avtor je poznavalec njihove biologije, neutruden opazovalec njihovih življenjskih navad, razmnoževalnih ciklov, vedenja ... pravi slovenski Faber.

Kraški rob avtor domiselno poimenuje "slovenski koralni greben". Splošnim in strnjanim opisom narave avtor dodaja prenekatero izvirne in lastne neobjavljene entomološke podatke – prav presunljivo zveni npr. dejstvo, da je avtor našel na obravnavanem območju

kar 317 vrst divjih čebel! Skozi drobne in natančne opise vrst, živalskih skupin in njihove razširjenosti nam pojasni, da je to območje biogeografsko na meji med Celino in Sredozemljem, ki ga naseljuje živelj obeh velikih sistemov – odtod takšna pestrost. V poglavju Voda na Krasu avtor poseže v geologijo, geomorfologijo in hidrologijo: spoznamo nadzemne kraške pojave in nekaj njihovega življa. Avtor verjetno najraje obiskuje t.i. "Kraško in severnoistrsko višavje" (Visoki kras), saj ga opisuje še posebej skrbno. Goli predeli Čičarije med Žbenvico in Kojnikom so avtorja privlačevali tako močno kot pisca teh vrstic. V knjigi se osebni vtisi mešajo z znanstvenimi spoznanji, vsepovsod pa je opaziti naravovarstveno noto in skrb za ohranitev tega območja.

Naslednji sklop je dolina Dragonje, ki je nekakšno pilotno območje za celotno Slovensko Istro, zgrajeno iz flišne kamnine. Avtor v tekstu in fotografijah dobro povzame geomorfološke posebnosti reke, vegetacijske in floristične značilnosti in se posveti živalim in njihovim zgodbam. Če je kraški del kompletnejši, je del, ki je posvečen Istri, vsekakor preskromnega obsega; omejen je le na Dragonjo, čeravno bi si zaslužil več prostora. Zato pa so kot poseben sklop obdelane Sečoveljske soline. O njih je bilo v zadnjih dveh desetletjih veliko napisanega in fotografiranega. Avtor se je v tem delu pravzaprav le dotaknil samosvojega sveta solin, izognil se je ponavljanju vsesplošno znanih dejstev in je zato teksta manj, zanimivi pa so odstavki od nižjih živalih, ki so bile na solinah doslej prezrte.





Predzadnje poglavje je posvečeno sami morski obali, ki je posebnost že zaradi slikovitih flišnih klifov, ki tvorijo vse mogoče oblike in zaradi erozije neprestano spreminjajo svojo podobo. Tudi tu je manj poudarka na rastlinstvu, tekst je bolj skop in se posveča živalim. Zadnje poglavje – Radoživa jesen – je najbolj subjektivno obarvano, povzema jesenske podobe vseh opisovanih pokrajin, dodaja nove živalske zgodbe in se dotakne tudi človeka in rastlinskih kultur: oljke, vinske trte...

Lahko poudarimo, da je knjiga občudovanja vredna že zaradi tehnično in estetsko dovršenih fotografij, tekst, ki je sicer kratak, pa je brez odvečnega leporečenja in ponavljanja znanih dejstev. Želeli bi si le, da bi bil kraški del, ki je temeljiteje obdelan kot istrski, v prihodnje tekstovno še razširjen in dopolnjen z istrskim delom, toda to bi bila že druga knjiga...

Mitja Kaligarič

Ivan Gams: KRAS V SLOVENIJI V PROSTORU IN ČASU.  
Založba ZRC, Ljubljana, 2003, 516 str.

Ko je Stvarnik končal ustvarjanje sveta, mu je ostal še velik kup kamenja. Da bi kamenje nikomur ne bilo napoti, je sklenil, da ga vrže v morje. Vzel je veliko vrečo, vanjo natlačil kamenje, jo trdno zavezal, da bi vse skupaj proti morju zalučal.

Zlodej pa, ki je nevoščljiv Bogu in ljudem, si je mislil: "Čakaj, gospod Bog, bom pa vrečo pretrgal."

Ko je vreča letela visoko pod nebom, se je zlodej pognal do nje, naredil veliko luknjo.

Kamenje se je usipalo po deželi, le malo ga je prišlo v morje.

Tako je nastala kamnita dežela, naš Kras.

(časopis Jaslice, 1928, Mirko Skočir)

Akademik Ivan Gams, doma iz Slovenj Gradca, redni profesor za fizično geografijo, praktično vse svoje življenje raziskuje površinske in podzemeljske kraške pojave, se ukvarja z geomorfologijo in klimatogeografijo slovenskega ozemlja ter s pokrajinsko ekologijo in regionalno geografijo Slovenije.

Minilo je že skoraj trideset let od izida njegovega prvega monografskega opisa krasa v knjigi Kras, zgodovinski, naravoslovni in geografski oris. To je dolga doba glede na hitrost razvoja krasoslovja pri nas in po svetu, tako da je bila pričujoča knjiga več kot dobrodošla osvežitev.

Knjiga Kras v Sloveniji - v prostoru in času je doslej najobširnejši in najbolj zaokrožen pregled našega krasa. Avtor nas vodi skozi osem poglavij, v katerih nas po-

drobno, a nikakor ne suhoparno popelje v svet, ki je s svojimi nenavadnimi pojavi vzbujal zanimanje že v davni antiki. V poglavju Od kamna in Krasa do krasoslovja razloži izvor imena kras iz paleoevropske osnove kara, ki jo srečamo v številnih zemljepisnih imenih. Kras je s svojo posebnostjo navdihoval številne pesnike, od Livija in Plinija do Vergila in Danteja. Posebno pozornost pa namenjen raziskavam in opisom Cerkniškega jezera, ki je od nekdanj zbuvalo pozornost njegovih raziskovalcev. Verjetno gre to pripisati povezanosti jezera s podzemljem, od koder naj bi, po Clüverju (1580-1623), vodo prinašale race. S presihajočim jezerom so se ukvarjali številni "raziskovalci", od Kircherja in Valvasorja, ki razlaga princip polnjenja in praznjenja jezera z natega, do Nagla in Gruberja, ki zelo stvarno predstavi kraške pojave in teorijo o nastanku Cerkniškega jezera.

Termin kras so, v različnih obdobjih, uporabljali za opis veliko različnih pojmov, kar je v knjigi zelo nazorno predstavljeno, od opisov, da je kras kamnita in puščavska pokrajina, do kompleksnih definicij, ki opredeljujejo kras kot ozemlje, kjer vlada zaradi poklinske prepustnosti kamnine podzemeljsko (kraško) pretakanje vode, učinkovito kemično raztapljanje kamnin in kjer so lahko razvite tudi značilne površinske in podzemeljske oblike.



Kras je delo vode, pravi avtor v poglavju Kraška hidrografija. Kje pa je voda na krasu? Že od nekdanj je bila voda jedro sporov med prebivalci te sušne pokrajine, kjer je bila vsa skrb posvečena rabi vode iz izvirov, vse premalo pa so se ljudje ukvarjali z zajetjem padavinske vode na kraškem površju. Zelo zanimiva je primerjava krasa z živim organizmom, kjer ožilje ponazarjajo prevodniki, voda pa kri.

Ob koncu tega poglavja je bralcu že povsem jasno, da je poleg kamna za kras bistvena voda. Ni krasa brez vode! S krasom so povezani številni hidrogeografski pojmi, od ponikalnic ali sušic, presihajočih jezer, ponorov, požiralnikov, do različnih izvirov, katerih imena govorijo o njihovi obliki, načinih nastanka in nena- zadnje tudi o pokrajini in ljudeh, ki so jih tako poimenovali.

Za tiste, ki so bolj doma v fizikalni kemiji, bo dobrodošlo poglavje o izredno kompleksnih kraških procesih, ki bi jih lahko opredelili kot neznatne spremembe, gledano s strani življenjske dobe človeka, z ogromnimi posledicami, gledano s strani življenjske dobe Zemlje.

Bralca pritegne že sam naslov naslednjega poglavja jame, v katerih so nekdanj videli vhod v strašno podzemlje, danes pa iščejo v njih razvedrilo, zdravje in nova spoznanja. Avtor se pri opisu različnih funkcij jam skozi tisočletja ne omeji izključno na opis jam slovenskega krasa, marveč poda širok pregled tako v zgodovinskem, geografskem kot tudi kulturnem pomenu jam po svetu. Bistveno je razširjen opis raziskovanja jam, saj so se metode dela pri odkrivanju novih delov jam v zadnjih treh desetletjih zelo spremenile, predvsem na račun novih tehnik jamskega potapljanja in novih teorij o začetni fazi kraškega pretakanja.

Štedi opis značilnosti kraškega reliefa z zelo slikovito razlago pojmov iz kraške terminologije.

Človek je edina napaka Narave. (William S. Gilbert)  
Človek je istočasno sramota in ponos narave. (A. Pope)

Človek spreminja kras, pravi Gams. Na splošno velja, da se danes kras spreminja iz puste in kamnite pokrajine v gmajne in gozdne površine, ki zakrivajo tipično kraško geomorfologijo. Velik vpliv človeka pa se ne kaže samo v tem. Bistven za spreminjanje podobe krasa je tudi razvoj turizma. Jame, ki so desetletja vzbujale človeka, niso več dovolj privlačne, zato gre razvoj v smeri novih turističnih destinacij. Poudarjen je tudi problem graditve cestnega omrežja in stavb, pri čemer se vse premalo upošteva biodiverzitetnost kraškega površja. Kljub vsemu pa avtor vidi upanje v naravovarstvenem osveščanju mladine in zavedanju posledic takšnega ravnanja za zdravo okolje.

Novo v knjigi je tudi sedmo poglavje, kjer je predstavljena geološka preteklost razvoja krasa pri nas in po svetu. Preostali del knjige pa je namenjen podrobnemu regionalnemu pregledu krasa v Sloveniji.

Dodani so daljši seznam strokovne literature, krasoslovni slovarček, kazalo krasoslovnih pojmov, kazalo turističnih in drugih pomembnih jam ter povzetek v angleškem jeziku. Strokovno izrazje je prilagojeno širokemu krogu bralcev.

Knjigo odlikuje pester izbor odličnih fotografij, geoloških kart, skic kraških pojavov in oblik ter jamskih profilov, ki bralcu, čeprav nestrokovnjaku s tega področja, pričarajo res celosten vpogled v to prečudovito pokrajino. Vsak, ki bo knjigo prebral, bo spoznal, kako je kras dejansko zelo kompleksen, da v krasu ne veljajo nobene splošno veljavne hipoteze in teorije. Kras je res nekaj izjemnega.

Nataša Režek Donev



## KAZALO K SLIKAM NA OVITKU

SLIKA NA NASLOVNICI: Zaradi globalnih klimatskih sprememb postaja voda čedalje pomembnejši naravni vir. (Foto: D. Podgornik)

Sl. 1: Voda si utira pot skozi gosto tropsko vegetacijo. Slapičje v Nacionalnem parku Erawan Falls na Tajskem. (Foto: D. Podgornik)

Sl. 2: Morska želva kareta (*Caretta caretta*) je nedvomno ena najbolj znanih ogroženih vrst v Sredozemlju in razmeroma pogost obiskovalec v našem morju, kar sicer slovenski in tuji javnosti ni znano. (Foto: T. Makovec)

Sl. 3: Poleti leta 2002 so v vodah blizu Senigallie v Jadranskem morju opazovali kita grbavca (*Megaptera novaeangliae*) in opazovanje tudi dokumentirali. To je prvi dokaz o pojavljanju te vrste v Jadranskem morju in šele šesti v celotnem Sredozemskem morju. (Foto: G. Stanzani)

Sl. 4: Gosti preplet obrasti, ki se je naselila na mrežastem cilindru, postavljenem ob ribji farmi v Piranskem zalivu (Slovenija). Prevladuje oranžni mahovnjak *Shizobrachiella sanguinea* in cevasti mnogoščetinci. (Foto: S. Alajbegović)

Sl. 5: Osušeni in razpokani solinski bazeni v Sečoveljskih solinah (Slovenija) dajejo obiskovalcu vtis aridnega, puščavskega okolja. (Foto: D. Podgornik)

Sl. 6: Poginula rakovica na osušenih tleh, poraslih s slanušami. (Foto: T. Makovec)

Sl. 7: Spodnje Kriško jezero je eno izmed značilnih slovenskih visokogorskih jezer, ki so brez ledenega pokrova največ 5 mesecev v letu. (Foto: G. Muri)

Sl. 8: Nekateri predele, kot npr. Coloured Canyon na Sinajskem polotoku, dež namoči le enkrat na leto. (Foto: D. Podgornik)

## INDEX TO PICTURES ON THE COVER

FRONT COVER: Owing to global climatic changes, water is becoming an increasingly important natural source. (Photo: D. Podgornik)

Fig. 1: Water making its way through thick tropical vegetation. Waterfall in Erawan Falls National Park, Thailand. (Photo: D. Podgornik)

Fig. 2: Marine turtle (*Caretta caretta*) is no doubt one of the most endangered Mediterranean species and a relatively frequent visitor to our sea, a fact not well known to the Slovene and foreign public. (Photo: T. Makovec)

Fig. 3: In the summer of 2002, a humpback whale (*Megaptera novaeangliae*) was observed in the waters off Senigallia in the Adriatic. This is the first documented evidence of this species occurring in the Adriatic Sea and only the sixth for the entire Mediterranean. (Photo: G. Stanzani)

Fig. 4: A thick interlacing of a fouling community (with predominant *Shizobrachiella sanguinea* and tubular bristleworms) that has colonised a meshed cylinder submerged along a fish farm in the Bay of Piran (Slovenia). (Photo: S. Alajbegović)

Fig. 5: Dry and cracked salt basins in the Sečovlje salt-pans (Slovenia) give a visitor the impression of an arid, desert-like environment. (Photo: D. Podgornik)

Fig. 6: A dead crab on dry ground overgrown with halophilous plants. (Photo: T. Makovec)

Fig. 7: The Lower Kriško jezero is one of the characteristic Slovene upland lakes that stay without their ice cover for 5 months in a year at the most. (Photo: G. Muri)

Fig. 8: Some parts of the world, such as Coloured Canyon on the Sinai Peninsula, are thoroughly soaked by rain only once a year. (Photo: D. Podgornik)

## NAVODILA AVTORJEM

**1. ANNALES:** *Anali za istrske in mediteranske studije - Annali di Studi istriani e mediterranee - Annals for Istran and Mediterranean Studies* (do 5. številke: *Anali Koprškega primorja in bližnjih pokrajin - Annali del Litorale capodistriano e delle regioni vicine - Annals of the Koper Littoral and Neighbouring Regions*) je znanstvena in strokovna interdisciplinarna revija humanističnih, družboslovnih in naravoslovnih vsebin v podnaslovu opredeljenega geografskega območja.

**2.** Sprejemamo prispevke v slovenskem, italijanskem, hrvaškem in angleškem jeziku. Uredništvo ima pravico prispevke jezikovno lektorirati.

**3.** Prispevki naj obsegajo največ 24 enostransko tipkanih strani s po 30 vrsticami. Na levi pustite 3 do 4 cm širok rob. Zaželeno je tudi (originalno) slikovno gradivo, še posebno pa oddaja prispevka na računalniški disketi v programih za PC (osebne) računalnike.

**4.** Naslovna stran tipkopisa naj vsebuje naslov in podnaslov prispevka, ime in priimek avtorja, avtorjeve nazive in akademske naslove, ime in naslov inštitucije, kjer je zaposlen, oz. domači naslov vključno s pošto številko in morebitnim naslovom elektronske pošte.

Uredništvo razvršča prispevke v naslednje **kategorije:**

*Izvirni znanstveni članki* vsebujejo izvirne rezultate lastnih raziskav, ki še niso bili objavljeni. Dela pošlje uredništvo v recenzijo. Avtor se obvezuje, da prispevka ne bo objavil drugje.

*Pregledni članki* imajo značaj izvirnih del. To so natančni in kritični pregledi literature iz posameznih zanimivih strokovnih področij.

*Predhodno sporočilo in Gradiva* imajo ravno tako značaj izvirnih del.

*Strokovni članki* prikazujejo rezultate strokovnih raziskav. Tudi te prispevke uredništvo pošlje v recenzijo in avtor se obveže, da prispevka ne bo objavil drugje.

*Poročila* vsebujejo krajše znanstvene informacije o zaključenih raziskovanjih ali kratek opis strokovnih in znanstvenih knjig ali srečanj. Taki prispevki ne smejo presežati 5 strani.

*Mladinske raziskovalne naloge* morajo biti urejene kot strokovna dela.

*Komentarji* so namenjeni aktualnostim s strokovnega področja. Ne smejo presežati 2 strani.

*Obvestila* so namenjena društvenemu življenju. Obsegajo 1 stran.

**5.** Prispevek mora vsebovati **povzetek** in **izvleček**. Izvleček je krajši (cca. 10 vrstic) od povzetka (cca. 30 vrstic) in v nasprotju s povzetkom tudi ne vsebuje komentarjev in priporočil.

V **izvlečku** na kratko opišemo namen, metode dela in rezultate. Navedemo, čemu smo delo opravili ali na-

pisali dokument. Na že objavljeno gradivo se sklicujemo le, če je to glavni motiv dela. Na kratko opišemo metode in tehnike dela - kolikor je potrebno za razumevanje. Nove tehnike opišemo le, kjer se razlikujejo od že znanih. Če v delu ne opisujemo eksperimentalnega ali praktičnega dela, opišemo vire informacij. Rezultate in zaključke lahko združimo. Kar se da informativno navedemo le, kaj smo ugotovili oziroma odkrili.

*Povzetek* začnemo s stavkom, ki vsebuje glavno sporočilo dela. Stavki naj bodo popolni in ne predožgi. Pišemo v tretji osebi, le izjemoma uporabimo glagole v neosebni obliki. Uporabljamo pravični strokovni jezik in se izogibamo slabše znanim kraticam. Ohraniti moramo osnovno informacijo in poudarke iz glavnega besedila. V povzetku ne sme biti ničesar, česar glavno besedilo ne vsebuje.

**6.** Avtorji so dolžni definirati in pripisati ustrezne **ključne besede** (pod izvlečkom) članka. Zaželeni so tudi **angleški (ali slovenski) prevodi** ključnih besed, podnapisov k slikovnemu in tabelarnemu gradivu. Priporočamo se še za angleški (ali slovenski) prevod povzetka, sicer bo za to poskrbelo uredništvo.

**7.** V besedilu se po možnosti držimo naslednjih poglavij:

1. Uvod.
2. Pregled dosedanjih objav.
3. Materiali in metode (Dokazni postopek).
4. Rezultati.
5. Razprava ali diskusija.
6. Zaključek (Sklepi).
7. Zahvala - če avtor želi.
8. Priloge - če je potrebno.
9. Literatura (Viri, Bibliografija).
10. Povzetek (Summary).
11. Izvleček.
12. Ključne besede (neobvezno).

**8.** Ločimo **vsebinske** in **bibliografske opombe**. Vsebinske opombe besedilo še podrobneje razlagajo ali pojasnjujejo, postavimo jih *pod črto*. Z bibliografsko opombo pa mislimo na citat - torej sklicevanje na točno določeni del besedila iz neke druge publikacije (navedemo tudi točno stran, kjer je citat objavljen) ali na publikacijo (članek) kot celoto (točne strani, kjer smo besedilo prevzeli, ne navajamo).

Bibliografsko opombo sestavljajo naslednji podatki: Avtor, leto izida in - le če citiramo točno določeni del besedila - tudi navedba strani.

Celotni bibliografski podatki citiranih in uporabljenih virov so navedeni v poglavju *Literatura* (Viri, Bibliografija).

Primer citata med besedilom:  
(Grafenauer, 1993, 11).

Primer navajanja vira kot celote, brez citiranja:  
(Grafenauer, 1993).

Popolni podatki o tem viru v poglavju Literatura pa se glasijo:

Grafenauer, B. (1993): Miti o "Istri" in resnica istrskega polotoka. V: Acta Histriae I. Koper, Zgodovinsko društvo za južno Primorsko, 9-52.

Če citiramo več del istega avtorja iz istega leta, poleg priimka in kratice imena napišemo še črke po abecednem vrstnem redu, tako da se viri med seboj razlikujejo. Primer:

(Grafenauer, 1993a); (Grafenauer, 1993b).

Bibliografska opomba je lahko tudi del vsebinske opombe in jo zapisujemo na enak način.

Posamezna dela ali navedbe virov v isti opombi ločimo s podpičjem. Primer:

(Gombač, 1996; Grafenauer, 1993b).

9. Pri citiranju arhivskih virov navedemo najprej arhiv, nato ime fonda ali zbirke in signaturo. V članku navajamo kratico arhivskega vira v oklepaju med besedilom. Kratico pa razložimo v poglavju o virih na koncu prispevka.

Primer navajanja arhivskega vira v oklepaju med besedilom: (PAK. RAG, 1)

Primer navajanja arhivskega vira v poglavju o virih: PAK. RAG - Pokrajinski arhiv Koper, Rodbinski arhiv Graviš, a. e. (arhivska enota) 1.

Podobno poskušamo ravnati pri uporabi časopisnih virov.

10. Poglavje o literaturi in virih je obvezno. Bibliografske podatke navajamo takole:

- Opis zaključene publikacije kot celote - knjige:

Avtor (leto izida): Naslov. Zbirka. Kraj, Založba. Npr.:

Verginella, M., Volk, A., Colja, K. (1995): Ljudje v vojni. Druga svetovna vojna v Trstu in na Primorskem. Knjižnica Annales 9. Koper, Zgodovinsko društvo za južno Primorsko.

V zgornjem primeru, kjer je avtorjev več kot dva, je korekten tudi citat:

(Verginella et al., 1995)

Če navajamo določeni del iz zaključene publikacije, zgornjemu opisu dodamo še številke strani, od koder smo navedbo prevzeli.

- Opis prispevka v zaključeni publikaciji - npr. prispevka v zborniku:

Avtor (leto izida): Naslov prispevka. V: Avtor knjige: Naslov knjige. Izdaja. Kraj, Založba, strani od-do. Primer:

Verginella, M. (1995): Poraženi zmagovalci. Slovenska pričevanja o osvobodilnem gibanju na Tržaškem. V: Verginella, M. et al.: Ljudje v vojni. Druga svetovna vojna v Trstu in na Primorskem. Knjižnica Annales 9. Koper, Zgodovinsko društvo za južno Primorsko, 13-51.

- Opis članka v reviji:

Avtor (leto izida): Naslov članka. Naslov revije, številka. Kraj, Založba, strani od-do. Primer:

Gombač, B. (1996): Osvoboditev Trsta maja 1945. Annales 8/96. Koper, Zgodovinsko društvo za južno Primorsko - Znanstveno-raziskovalno središče Republike Slovenije Koper, 141-150.

- opis ustnega vira:

Informator (leto izporočila): Ime in priimek informatorja, leto rojstva, vloga, funkcija ali položaj. Način pričevanja. Oblika in kraj nahajanja zapisa. Primer:

Baf, A. (1998): Alojzije Baf, r. 1930, župnik v Vižinadi. Ustno izporočilo. Magnetofonski zapis pri avtorju.

- opis vira iz internetnih spletnih strani:

www.home page ustanove (leto-mesec izpisa): celoten naslov podstrani. Primer:

www.zrs-kp.si (2000-07):

http://www.slo-istra.com/koper/zrs/zrs.html

Članki so razvrščeni po abecednem redu priimkov avtorjev ter po letu izdaje, v primeru da gre za več citatov istega-istih avtorjev.

11. Tiskarski znaki za poudarke naj bodo:

podčrtano za polkrepko,

valovito podčrtano za ležeče.

Računalniški zapis naj vključuje ustrezne oznake za bold in italics.

12. Kratice v besedilu moramo razrešiti v oklepaju, ko se prvič pojavijo. Članku lahko dodamo tudi seznam uporabljenih kratic.

13. Pri ocenah publikacij navedemo v naslovu prispevka avtorja publikacije, naslov, kraj, založbo, leto izida in število strani (oziroma ustrezen opis iz točke 10).

14. Prvi odtis prispevkov uredništvo pošlje avtorjem v korekturo. Avtorji so dolžni popravljeno gradivo vrniti v treh (3) dneh. Besedilo popravljamo s korekturnimi znamenji, ki jih najdemo na koncu Slovenskega pravopisa (1962), Ljubljana, ali v: Slovenski pravopis 1. Pravila (1990). Ljubljana, SAZU-DZS, 13-14.

Širjenje obsega besedila ob korekturah ni dovoljeno. Druge korekture opravi uredništvo.

15. Uredništvo prosi avtorje, naj navodila vedno upoštevajo. Ob vseh nejasnostih je uredništvo na voljo za vsa pojasnila.

UREDNIŠTVO

## INSTRUCTIONS TO AUTHORS

1. **ANNALES: Annals for Istran and Mediterranean Studies - Anali za istrske in mediteranske študije** (up to No. 5: *Annals of the Koper Littoral and Neighbouring Regions - Anali Koprškega primorja in bližnjih pokrajin*) is a scientific and research interdisciplinary review covering the humanities, sociology and natural science in the area as stated in the review's subtitle.

2. Articles (papers) written in Slovene, Italian, Croatian and English languages will be accepted. The Editorial Board reserves the right to have them linguistically revised and corrected.

3. Articles should be written on max. 24 pages with double spacing and on one side of the sheet only. On the left side of each page, a 3-4 cm wide margin is to be left. Original photographs, drawings and tables are welcomed, as well as diskettes containing the texts, together with reference to the programme used.

4. Title page of typescript is to include title and subtitle of the article (paper), author's name, any (academic) titles and name of institution by which employed or personal address with eventual E-mail address.

Articles are arranged in the following eight categories:

*Original scientific papers* containing not yet published results of the author's own research. Such works will be reviewed by scientists chosen by the Editorial Board. Authors oblige themselves not to offer their material to any other journal or magazine.

*Review articles* bearing the character of original works. These are critical and detailed reviews of literature from various interesting fields of research.

*Preliminary communication* and *Materials* also bearing the character of original works.

*Professional papers* presenting results obtained through research. They too will be reviewed, and authors oblige themselves not to publish them elsewhere.

*Reports* include short scientific information on integral research work or a short description of scientific or specialist books or meetings of experts. Such articles are not to exceed 5 pages.

*Youth research compositions* are to be presented in the same way as research works.

*Explanatory comments* include topical issues from various fields of research and are not to exceed 2 pages.

*Notices* include news from various associations and should not exceed 1 page.

5. Articles should include both **summary** and **abstract**.

*Abstract* is the shorter of the two (with up to 10 lines) and does not include, in contrast to summary (with up to 30 lines), explanatory comments and recommendations.

*Abstract* is to contain a short description of the purpose and methods of the work and its results. Author should also state why the work has been carried out and why a document has been written about it. References to the already published material are made only if this is the

main purpose of the work. Methods: if necessary, work methods and techniques are to be briefly described (new techniques are to be stated only if differing from the already known ones). If no experimental or practical work is described, sources of information are to be given. Results and conclusions may be incorporated. Findings are to be presented as briefly as possible.

At the beginning of summary the essential points of the carried out work are to be presented. Sentences should be concise and not too long. The text is to be written in the third person; verbs may be used in impersonal form only exceptionally. The not so well known abbreviations are to be avoided. Summary is to retain the basic information from the main part of the text, and should not contain anything that does not appear in the main text itself.

6. Authors are obliged to define and state **key words** (below abstract) in their articles. **English (or Slovene) translation** of key words, texts accompanying figures and tables are welcomed, as well as English (or Slovene) translation of abstracts; if this is not convenient, the Board of Editors will provide for it.

7. Texts should include, if at all possible, the following chapters:

1. Introduction
2. Works published to date
3. Material and methods
4. Results
5. Discussion
6. Conclusions
7. Acknowledgements (if desired by author)
8. Supplements (if necessary)
9. References (Sources, Bibliography)
10. Summary
11. Abstract
12. Key words

8. Two kinds of *notes* are distinguished: those regarding the **contents** of the text, and those referring to **bibliography**. The first elucidate the text in even greater detail and are to appear *at the bottom of the page (under line)*. Bibliographical notes, which are to appear in brackets in the text itself, deal with quotations and refer to a precisely stipulated part of the text from some other publication (the page on which quotation appears is to be therefore stated as well) or to a publication (article) as a whole (in this case no page from which the text has been taken is to be stated).

Bibliographical notes are made up of the following details:

Author, year of its publication, and page (but only if a precisely stipulated part of the text is quoted).

The entire bibliographical data of the quoted and used sources are to be stated under *References* (Sources, Bibliography).

Example of quotation referring to a precisely stipulated part of the text: (Sommerville, 1995, 11).

Example of source quotation as a whole, with no citation: (Sommerville, 1995).

The entire data of this source are to be stated in the references and sources chapter as follows:

**Sommerville, M. R. (1995):** Sex and Subjection. Attitudes to Women in Early-Modern Society. London-New York-Sydney-Auckland, Arnold.

If a number of works by the same author from the same year are quoted, letters in alphabetical order are to be stated apart from the author's surname and abbreviation of his first name, in order that the sources are clearly divided between each other. Example:

(Sommerville, 1986a); (Sommerville, 1986b).

Bibliographical note can also be a part of the note referring to the contents and is to be written in the same way, i.e. in brackets within the note referring to the contents.

Separate works or source quotations under the same note are to be separated with semicolon. Example: (Sommerville, 1986b; Counce, 1994).

**9. When quoting archive sources,** the archive is to be stated first, then the name of the fund or collection and shelfmark. The abbreviation of archive source is to be stated in brackets in the text of the article. The abbreviation is to be explained in the references chapter at the end of the article.

Example of citing archive source in brackets in the text itself: (ASV. CSM, 240).

Example of citing archive source in the reference chapter: ASV. CSM - Archivio di Stato di Venezia. Cinque Savi alla Mercanzia, fasc. 240.

Review sources are to be stated in the same way.

**10. The references and sources chapter is compulsory.** Bibliographical data are to be stated as follows:

- Description of **integral publication:**

Author (year when published): Title. Volume - Collection. Place of publication, published by. Example:

**Counce, S. (1994):** Oral History and the Local Historian. Approaches to local history. London and New York, Longman.

If there are *more than two authors*, the work can be also cited as:

(Matthews et al., 1990, 35)

If a specific part from an integral publication is quoted, the page numbers from which the quotation has been taken are to be added to the above description.

- Description of the **article (paper) in integral publication** - e.g. text in a collection of scientific papers: Author (year of its publication): Title of the paper. In: Author of the book: Title of the book. Volume - Collection. Place of publication, published by, pages from - to. Example:

**Matthews, R., Anderson, D., Chen, R. S., Webb, T. (1990):** Global Climate and the Origins of Agriculture. In: Newman, L. F. (ed.): Hunger in History. Food Shortage, Poverty, and Deprivation. Oxford-Cambridge, Blackwell, 27-55.

- Description of **article in certain review:** Author (year of its publication): Title of article. Name of review, its number. Place of publication, published by, pages from - to.

Example:

**Sluga, G. (1996):** Identity and Revolution: The History of the "Forty Days" of May 1945. Annales 8/96. Koper, Zgodovinsko društvo za južno Primorsko - Znanstveno-raziskovalno središče Republike Slovenije Koper, 125-140.

- description of personal communication:

Informant (year when communication was given): Name and surname of informer, year of birth, function or position held. Manner of the testimony's presentation. Form and place where record was made. Example:

**Baf, A. (1998):** Alojzije Baf, 1930, priest at Vižinada. Personal communication. Tape recording at author's place.

- description of source from the Internet websites:

www. home page of institution (year-month when registered): full address of sub- page. Example:

**www.zrs-kp.si (2000-07):**

<http://www.slo-istra.com/koper/zrs/zrs.html>

If the same author(s) is (are) cited a number of times, the articles are to appear in alphabetical order of the authors' surnames and year of publication.

**11. Printer's marks for accentuations** are to be as follows:

underlined for **semi-bold**,  
undulatory line for *italics*.

Computer notation is to include suitable marks for bold and *italics*.

**12. Abbreviations** in the texts are to be explained in brackets when appearing for the first time. A list of used abbreviations can be added to the article.

**13. When assessing a publication,** its author, title, place, publishing house, year of publication and page numbers (or appropriate description from Item 10) are to be stated in the title of the article.

**14. First copies of printed articles** will be sent to authors for **proof-reading**. Authors are obliged to return them in three (3) days. No new sentences are allowed to be added during proof-reading. The second (printing) proofs will be read by the Editorial Board.

**15. Authors are kindly requested** to consider these instructions at all times. In case of any indistinctness, please do not hesitate to contact the review's Editorial Board.

EDITORIAL BOARD

# ANNALES

Anali za istrske in mediteranske študije  
Annali di Studi istriani e mediterranei  
Annals for Istrian and Mediterranean Studies

series historia naturalis, 13, 2003, 1  
Supplement

## BIOFAQs

BIOFiltration and AQUaculture: an Evaluation of Substrate Deployment Performance with Mariculture Developments

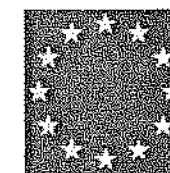
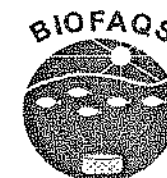

National Institute of Biology, Marine Biology Station Piran,  
Slovenia

Institute of Marine Biology of  
Crete, Greece

Natural Environment Research  
Council, UK

Israel Oceanographic and  
Limnological Research Ltd., Israel

University of Portsmouth Higher  
Education Corporation, UK

University of Haifa, Israel

University of Southampton, UK



## VSEBINA / INDICE GENERALE / CONTENTS

<b>Kenneth D. Black:</b> Editorial .....	1	<b>Ehud Spanier, Anat Tsemel, Hadas Lubinevski, Ayalon Roitemberg, Amir Yurman, Stephen Breitstein, Dror Angel, Noa Eden &amp; Timor Katz:</b> Can open water bio-filters be used for the reduction of the environmental impact of finfish net cage aquaculture in the coastal waters of Israel? .....	25
<b>Vlado Malačič &amp; Janez Forte:</b> Distribution of the food surplus and faecal particles on the seabed below a fish farm in the Bay of Piran .....	3	<i>Razpršitev ribje hrane in iztrebkov na dno pod ribogojnico v Piranskem zalivu</i>	
<b>Sonja Lojen, Dror Angel, Timor Katz, Manolis Tsapakis, Nives Kovač &amp; Alenka Malej:</b> <sup>15</sup> N enrichment in fouling communities influenced by organic waste deriving from fish farms .....	9	<i>Izotopska sestava dušika v morskih organizmih v vplivnem območju ribjih farm</i>	
<b>Nives Kovač, Branko Čermelj &amp; Sonja Lojen:</b> Sedimentation and composition of particulate matter in a marine fish farm (Gulf of Trieste, northern Adriatic); preliminary results .....	13	<i>Sedimentacija in sestava suspendirane snovi v območju ribogojnice (Tržaški zaliv, severni Jadran); preliminarni rezultati</i>	
<b>Elisabeth J. Cook &amp; Kenneth D. Black:</b> Early colonisation of biological filters suspended in waters adjacent to caged mariculture activity, West Scotland .....	17	<i>Zgodnje naseljevanje biofiltriranih, visečih v morju ob ribogojnici na zahodnem Škotskem</i>	
<b>Aleksandra Frumen, Borut Vrišer &amp; Alenka Malej:</b> Suspended biofilters: succession of fouling communities immediately adjacent to a fish cage and control location .....	21	<i>Sukcesije združb obrasti na lebdečih biofiltriranih v neposredni bližini ribogojnice in na kontrolni lokaciji</i>	
		<b>Eugenia Apostolaki, Manolis Tsapakis, Tatiana Tsagaraki, Kostantia Papadopoulou &amp; Ioannis Karakassis:</b> Effect of time of first deployment and duration on the succession of benthic organisms on biofilters used to mitigate impact of fish farms on water quality in Crete .....	29
		<i>Učinek časa prve postavitve in trajanja na sukcesijo bentoških organizmov na biofiltriranih, uporabljenih za zmanjševanje učinkov ribogojnic na kakovost vode na Kreti</i>	
		<b>Dror L. Angel, Noa Eden, Timor Katz &amp; Ehud Spanier:</b> Mariculture – environment interaction and biofiltration in oligotrophic Red Sea waters: the value of strong signal to noise ratios .....	33
		<i>Okoljske interakcije v marikulturi in biofiltriranju v oligotrofnih vodah Rdečega morja</i>	
		<b>Valentina Turk &amp; Alenka Malej:</b> The influence of fish cage aquaculture on bacterioplankton in the Bay of Piran (Gulf of Trieste, Adriatic Sea) .....	37
		<i>Vpliv marikulture na bakterioplankton v Piranskem zalivu (Tržaški zaliv, Jadransko morje)</i>	
		<b>Ken Collins &amp; Jenny Mallinson:</b> Biofilter community oxygen consumption rates .....	43
		<i>Poraba kisika na biofiltriranih</i>	
		Plates/Tables .....	47

## THE BIOFAQS PROJECT: BIO-FILTRATION AND AQUACULTURE: AN EVALUATION OF SUBSTRATE DEPLOYMENT PERFORMANCE WITHIN MARICULTURE DEVELOPMENTS

*Kenneth D. BLACK*

Scottish Association for Marine Science, Dunstaffnage Marine Laboratory Oban, UK-Argyll, PA37 1QA  
E-mail: kdb@dml.ac.uk

### EDITORIAL

The use of biofiltration to improve water quality in land-based, intensive aquaculture systems where water is recycled is standard practice. However, most fin-fish mariculture is undertaken under intensive farming conditions in open cage culture in inshore coastal waters. At present, such farms are solely reliant on the local environment for waste assimilation services. The accumulation of particulate organic waste material on the seabed can have substantial effects on the biological composition of the seabed communities (Pearson & Black, 2001) and, in severe cases, impact on the health and growth of target culture species with potentially deleterious effects on the economic performance of the farm. In many countries regulations to control the scale of fish farming are based on constraining impacts on the seabed ecology and sediment biogeochemistry. There has also been considerable interest in the effects that dissolved organic and inorganic nutrients from intensive open aquaculture may have on the marine ecosystem.

A large proportion of externally supplied fish feed is lost to the marine environment as particulate organic carbon rich in nitrogen and phosphorus (Black, 2001). Given the parlous state of many of the world's fisheries, this represents a waste of valuable resources. Since ancient times practices involving the co-culture of species at different trophic levels has been used to increase the yield of agriculture and maximise the yield of edible biomass from available nutrient supplies. The world's most efficient traditional aquaculture/agriculture system was developed in China where dike-and-pond systems involving carp polyculture, sugarcane, vegetables, rice

and fruit were nourished by pig, duck, water buffalo and human manures (Smil, 2001).

Thus two possible objectives for research in the area of biofiltration and aquaculture are 1) the reduction in environmental impact by increasing the assimilative capacity of the local environment and 2) the more efficient use of nutrients to increase farm production. A third possible objective is that of increasing local biodiversity although the value of this aspect both to the ecosystem and to society is much more difficult to quantify.

BIOFAQs (BIOFiltration and Aquaculture: an Evaluation of Substrate Deployment Performance with Mariculture Developments) was funded under Framework Programme 5: Quality of Life of the European Commission.

The main initial objective related to reduction in environmental impacts with three inter-related subsidiary objectives:

1. To quantify the effectiveness of bio-filter use in association with mariculture within both economic and environmental frameworks on a pan-European scale.
2. To optimise bio-filter designs and placement protocols in line with geographical differences and validated model predictions. This objective was assessed principally through mesocosm experimentation.
3. To examine the environmental and regulatory options governing post-bio-filter usage and to provide detailed economic analyses of bio-filter use compared with existing practices.

Initial experimental work focused on the deployment of identical plastic mesh cylinders in each of 4 study sites in Scotland, Slovenia, Greece and Israel. These were moored with a high degree of replication in waters

closely adjacent to active marine fish farms and allowed to be colonized with local flora and fauna. In each country the balance between heterotrophic and autotrophic colonizers was different as was the colonizing succession and the predation or grazing response.

Removing nutrient from the fish farming system using naturally settling communities would involve not only establishing a large colonial biomass but a means of harvesting this and the production of useful products. On the basis of the experience of the initial experiments and as a consequence of discussions with the aquaculture industry, it was decided to pursue the second phase of experiments using substrates likely to be preferentially settled with a more valuable secondary harvest. For example in Scotland, ropes used for the culture of edible mussel *Mytilus edulis* were deployed. Mussels settling on these ropes demonstrated increased growth compared to mussels grown in control locations outside of the farm influence.

Economic models of secondary production both with respect to the value of reduced environmental impact

from fin-fish culture and the value of the secondary harvest have been evaluated as has the various legal and regulatory issues of biofilter deployment across a range of different jurisdictions.

At the time of writing, results from the project are still being analyzed and evaluated and several questions remain to be answered. The present volume represents a collection of some of the research that has been undertaken during the course of this work. Hopefully, it will give more than a flavour of what is to come when the project is complete and the data from across the range of sites and experiments are assimilated and synthesized. Progress of the BIOFAQs project can be monitored by reference to the project web site at [www.sams.ac.uk](http://www.sams.ac.uk).

Integrated aquaculture is an old concept currently being rejuvenated by research effort in many countries. Hopefully, the result will be in more sustainable, productive aquaculture providing crops of high nutritional value while minimizing harmful effects on the marine environment.

## PROJEKT BIOFAQ: BIOFILTRACIJA IN AKVAKULTURA

### IZVLEČEK

Človek se z marikulturo ukvarja že od nekdaj. V novejšem času pa je pokazal precejšen interes za obsežnejše raziskave v tej obliki marikulture, in sicer z namenom, da se ugotovijo potencialne prednosti za okolje prek minimiziranja odpadka, še bolj pa neposredne gospodarske koristi s proizvodnjo sekundarnih pridelkov. BIOFAQ, projekt Evropske unije, želi dognati ekološki proces koloniziranja na umetnih podlagah, razvrščenih ob ribogojnicah, poleg tega pa tudi raziskati pravne in gospodarske okvire za takšen razvoj v več evropskih jurisdikcijah. Pričujoči sklop vsebuje kratke članke, ki pojasnjujejo nekatere pomembne vidike tega projekta.

## PROGETTO BIOFAQ: BIO-FILTRAZIONE ED ACQUACOLTURA

### SINTESI

L'acquacoltura integrata viene praticata da tempi remoti. Di recente è aumentato considerevolmente l'interesse scientifico per tale forma di acquacoltura allo scopo di determinare, tramite la minimizzazione dei materiali di scarto, potenziali benefici all'ambiente e benefici economici derivanti dalla produzione di raccolti secondari. Il progetto EU BIOFAQ è finalizzato a determinare i processi ecologici di colonizzazione di substrati artificiali posizionati in prossimità di allevamenti di pesci e, in aggiunta, a esaminare le cornici legali ed economiche per tali tipi di interventi in diverse giurisdizioni europee. Questo volume contiene brevi articoli che sommariamente evidenziano alcuni importanti aspetti del progetto.

### REFERENCES

**Black, K. D. (2001):** Environmental, Economic and Social Impacts of Mariculture. In: Steele, J., S. Thorpe & K. Turekian (eds.): Encyclopedia of Ocean Sciences. Academic Press, London, p. 1578-1584.

**Pearson, T. H. & K. D. Black (2001):** The environmental impact of marine fish cage culture. In: Black, K. D. (ed.):

Environmental Impacts of Aquaculture. Sheffield Academic Press, p. 1-31.

**Smil, V. (2001):** Enriching the Earth: Fritz Haber, Carl Bosch, and the transformation of world food production. The MIT Press, Cambridge, Massachusetts and London, England.

short scientific article  
received: 2003-09-05

UDK 639.33:574.6(262.3-18)

## DISTRIBUTION OF THE FOOD SURPLUS AND FAECAL PARTICLES ON THE SEABED BELOW A FISH FARM IN THE BAY OF PIRAN

Vlado MALAČIČ & Janez FORTE

National Institute of Biology, Marine Biology Station, SI-6330 Piran, Fornače 41

E-mail: malacic@mbss.org

### ABSTRACT

Simulations of the spread of food pellets and faecal particles beneath a fish farm were performed on the basis of field measurements of currents and laboratory measurements of settlement velocities. The simulations showed that the patch of the food surplus at the sea floor covered an area smaller than 30 x 15 m, while faecal pellets should have covered an area smaller than 300 x 150 m.

**Key words:** mariculture, currents, environment, Bay of Piran

## DISTRIBUZIONE DI ECCESSO DI MANGIME E PARTICELLE FECALI SUL FONDO MARINO SOTTOSTANTE UN ALLEVAMENTO DI PESCI (BAIA DI PIRANO)

### SINTESI

L'articolo riporta simulazioni della dispersione di pallottoline di mangime e particelle fecali al di sotto di un allevamento di pesci, ottenute da misurazioni di correnti sul campo e misurazioni in laboratorio delle velocità di affondamento del materiale organico. È stato dimostrato che l'eccesso di mangime va a ricoprire un'area minore di 30 x 15 m, mentre le particelle fecali restano confinate in un'area di 300 x 150 m.

**Parole chiave:** maricoltura, correnti, ambiente, Baia di Pirano



INTRODUCTION

Fish farming, in comparison to fishing of the wild stocks, has economic advantages, but it also presents a threat to the ecological equilibrium in the marine environment. Different influences are coming from the mariculture in a form of the food supply surplus, solid and dissolved excrements, and as a wide range of different pharmaceutical drugs. There are two types of particles that enter the ecosystem from the fish farm: the fish food surplus, that is the part of the food supply that is not consumed by fish and passes through the nets of the cage, and fish excrements. This process increases the consumption of dissolved oxygen (short-term impact) and the accumulation of decayed material in the upper layer of the sediment. The latter process is considered as a long-term impact since this material at the surface film of the seabed is later regenerated. This means that proper planning of the fish farm location should consider the amount of particles deriving from the farm and their spreading around the cages. The paper presents the simulation of the distribution of food surplus particles and faecal pellets on the seabed due to the horizontal advection of the water mass during their sinking below the fish farm.

MATERIALS AND METHODS

The shallow Bay of Piran (Fig. 1) is part of the north-

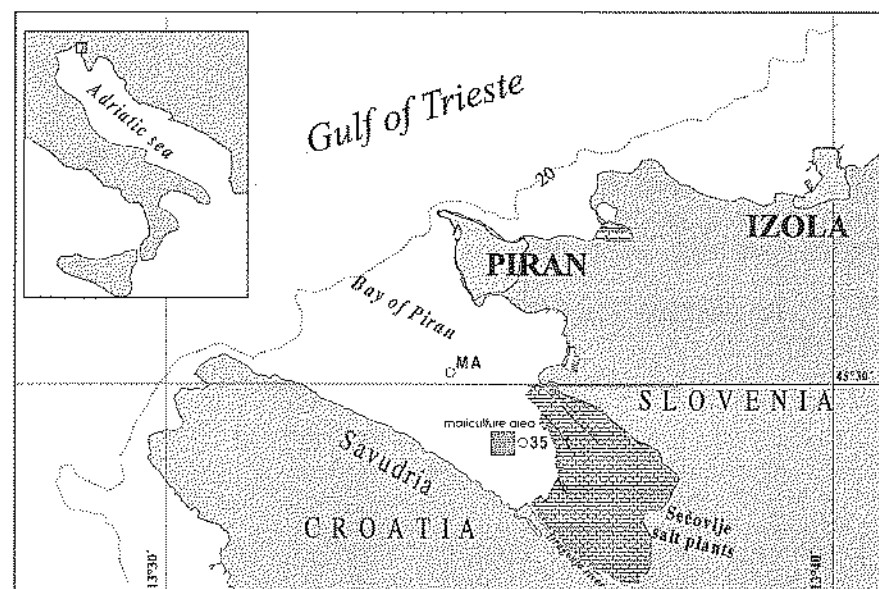

Fig. 1: Location map of the fish farm and the nearby measurement stations MA (45°30.20' N, 13°34.20' E, depth 16 m) and 35 (45°29.40' N, 13°35.00' E, depth 12 m) from where the long-term temperature and salinity records were applied for the estimate of density on the farm site.

Sl. 1: Skica lokacije ribogojnice in bližnjih merilnih postaj MA (45°30.20' N, 13°34.20' E, 16 m) in 35 (45°29.40' N, 13°35.00' E, 12 m), kjer so bile opravljene dolgoročne meritve temperatur in slanosti za kasnejši izračun gostote morske vode.

ern Adriatic Sea and is opened to the Gulf of Trieste. The depth beneath the cages is 13 ± 1 m; depth variations are caused mainly by tides. The sea floor is smooth and muddy, with a moderate declination towards the open sea. The water column structure resembles that of the Gulf of Trieste (Malačić, 1991) with seasonal temperature variations. However, at the fish farm site the influence of the river Dragonja modifies the vertical stratification in the shallow water column, in particular the distribution of salinity. Records of monthly data collected at the two nearby stations that are less than 1.5 km away (Tab. 1) show that during the spring-summer time (Forte, 2001) temperature in the upper part of the water column varies between 18-26 °C, and between 12-17 °C in its lower part. Salinity also shows some seasonal variations, although less pronounced, for it varies between 28.0 – 38.5 PSU in the upper part of the water column.

Currents were measured on the fish farm site (45°29.226' N, 13°34.838' E) with the acoustic Doppler current-meter profiler of Nortek AD company (NDP) mounted on the sea floor. The instrument scans the water column above with three beams and outputs the velocity of layers that are 1 m thick. The average period of currents was 600 s, while the sampling period was 3600 s. Measurements were performed in the spring-summer period, from 19 April to 4 July and from 31 July to 31 August 2000.

Tab. 1: Simple statistics of 1362 temperature and salinity data obtained in 25 years in the Bay of Piran (1975-2000). The average value is denoted with <>, and deviation with SD. Sampling was performed at stations 35 and MA and at four different depths: on the surface, at depths ranging from 5 to 10 m, and just above the sea floor (Ruttner sampling).

Tab. 1: Osnovni statistični podatki o temperaturah in slanostih, izračunani iz 1362 meritev, pridobljenih v 25 letih (v obdobju 1975-2000) v Piranskem zalivu. Znak <> označuje srednjo vrednost, SD pa standardno deviacijo. Meritve so bile napravljene na postajah 35 in MA na štirih globinah (površina, 5 m, 10 m in tik nad dnom – Ruttnerjev vzorčevalnik).

	T (°C)	S (PSU)	σ <sub>T</sub> (kg/m <sup>3</sup> )
<>	15.67	36.88	27.16
SD	5.42	1.02	1.73
Min	5.85	28.77	20.69
Max	27.63	39.83	30.89

Sinking velocity of fish food and fish excrements was measured in the lab. Measurements of the sinking velocity of fish food were performed in a plastic cylinder filled with seawater with salinity of 37.5 PSU and temperature of 22.5 °C. This seawater density is thereafter calculated as 25.9 kg/m<sup>3</sup>. From twelve throws of fish pellets, the highest and the lowest measured velocity were eliminated; from the remaining ten values the average and the standard deviation (SD) were calculated. We combined the sinking velocity of fish food with the current-meter data to predict the distribution of unconsumed fish food on the seabed below fish cages.

This idea of simulating the distribution of unconsumed fish food was extended to faecal particles. For this reason, faeces were collected from the fish cage using a particular trap of polyethylene foil. The foil covered an area of 1 m<sup>2</sup> at the bottom of the cage, with a plastic bottle attached in its centre as a recipient of the sinking material. In the laboratory, a sample of collected particles with a volume of 1.5 l was diluted to 5 l and carefully mixed to achieve more homogeneous distribution of excrement. From this mixture, a sub sample of 5 ml was taken and released into another plastic cylinder, in which the sinking velocity was measured. This second cylinder was filled with seawater collected a few miles away, with temperature of 22.0 °C, salinity of 38.5 PSU, and the calculated density of 26.9 kg/m<sup>3</sup>.

RESULTS AND DISCUSSION

In the year 2000, currents at the fish farm were measured twice, in the late spring (19 April – 5 July) and summer (31 July – 31 August 2000) periods. Frequencies of the directions of currents show (Forte, 2001) that in

late spring the prevailing currents over the whole water column were directed towards NE and E (30% – 40%), while they were more evenly distributed during the summer, with more frequent directions towards NW, W and SW (15% – 20%). In both cases, the frequency of directions towards the south was not higher than 10%, indicating that over the entire water column the currents were mostly oriented away from the mouth of the Dragonja river (Fig. 1) during the spring-summer period. The distribution of velocity magnitude in different directions (eight sectors) show higher values of currents in NE and E directions during late spring, while during the summer period currents had evenly distributed magnitude in all directions.

Currents in the surface layer 11 m above the NDP and about 2 m below the sea-surface deviated from the rest of the water column during the spring period. The most frequent directions then were to the E or W, and their velocities reached values of 0.17 m/s in the W direction and of 0.15 m/s in the E direction. During the summer period, however, surface currents had similar directions as the rest of the water column. This indicates that the surface layer is dominantly wind-driven, since during the spring period the wind is more frequent than during the summer (Ogrin, 1995), while in the rest of the water column tidal and density driven currents prevail.

Tab. 2: Sinking velocities (mean±SD) of fish food pellets and faecal particles, measured in the lab. Seawater density for the experiment with pellets was 25.9 kg/m<sup>3</sup> and density for the experiment with faecal particles 26.9 kg/m<sup>3</sup>.

Tab. 2: Hitrosti padajočih delcev ribje hrane in delcev ribjih iztrebkov (srednja vrednost±SD). Meritve so bile opravljene v laboratoriju. Gostota morske vode med poizkusom z ribjo hrano je bila 25,9 kg/m<sup>3</sup>, medtem ko je bila gostota med poizkusom z delci iztrebkov 26,9 kg/m<sup>3</sup>.

	Sinking velocity (cm/s)	
	Pellets	Faeces
<>	5.72	0.64
SD	0.15	0.05

Sinking velocities of food pellets were estimated in the lab as 5.7 ± 0.15 cm/s (Tab. 2). In comparison to food pellets, the sinking of faecal particles was significantly slower. Their sinking velocity was estimated at 0.64 ± 0.05 cm/s, being roughly 8.9 times smaller than that of food pellets. This means that through the water column of the same density as the one of the seawater in lab cylinder, food pellets would pass vertically through a layer of thickness of 1 m in less than 18 s, and would reach the sea floor from the surface in less than 3.8 minutes. Faecal particles would travel through a

layer of 1 m on average in less than 157 s, and would reach the sea floor in less than 34 minutes. Since currents were measured with a sampling rate of 1 hour, we reasonably assumed that both types of particles were sinking through the water column during the single measurement cycle, and that the sampling period of 10 minutes represents currents during the sinking period of half an hour. It is estimated that the range of sinking speed is larger due to the unknown densities of the water column, food pellets and faecal particles, and due to the unknown geometry of the latter during the entire measurement period.

We may reasonably suppose that food pellets and faecal particles of density  $\rho_p$  are sinking laminarily with a constant speed within a layer of a constant density  $\rho$ . In the balance of forces that act on sinking particles, a problem arises with the friction force, since the geometry of food pellets and faecal particles is not sufficiently known. However, we may qualitatively describe the linear friction law (Kundu, 1990) that holds for the low Reynolds numbers ( $Re = vd/\eta$ , where  $v$  is the sinking speed,  $d$  the typical dimension across the particle, and  $\eta = 10^{-6} \text{ m}^2 \text{ s}$  is the kinematic viscosity at 20 °C). It is estimated that  $Re$  is smaller than 300 for food pellets ( $v = 0.06 \text{ m/s}$  and  $d < 5 \cdot 10^{-3} \text{ m}$ ), and that  $Re$  is below 13 ( $v = 6.4 \cdot 10^{-3} \text{ m/s}$  and  $d < 2 \cdot 10^{-3} \text{ m}$ ) for faecal particles. This indicates that the linear dependence of friction force on the sinking velocity is applicable and the friction force is

parameterised as  $K\rho_p \eta d v$ , where  $K$  is the dimensionless constant that accounts for geometry ( $K = 6 \pi$  for sphere-like particles). The balance between the buoyancy force  $(\rho_p - \rho)gV$  ( $g = 9.81 \text{ m/s}^2$  is the gravity acceleration and  $V$  the volume of a particle), and the friction force yields the sinking velocity as:

$$v = \frac{(\rho_p - \rho)gV}{K\eta\rho d}$$

This means that if the density of a sinking particle  $\rho_p$  is known, the sinking speed is decreasing with the ambient density in an inverse linear way, proportional to  $1/x - \rho_0/\rho_p$ , where  $x = \rho_0/\rho$  is the ratio of densities, with  $\rho_0$  being the density at which the sinking speed was measured. The density is related to the density excess  $\sigma_T$  as  $\rho = 1000.0 + \sigma_T$ . Tab. 1 shows that over the period of 25 years  $\sigma_T$  in the Bay of Piran has varied for less than 10.2  $\text{kg/m}^3$ ,  $x$  therefore for less than 1%, and so has the sinking speed due to variations of the ambient density. There are no estimates as to the density variations of particles, which are probably much higher for faecal particles. Their volume also affects the sinking velocity. There are, however, no estimates of volume variations that could vary significantly with the age of fish population, and also of the food supply type. It is expected, however, that the volume of food pellets does not vary that much.

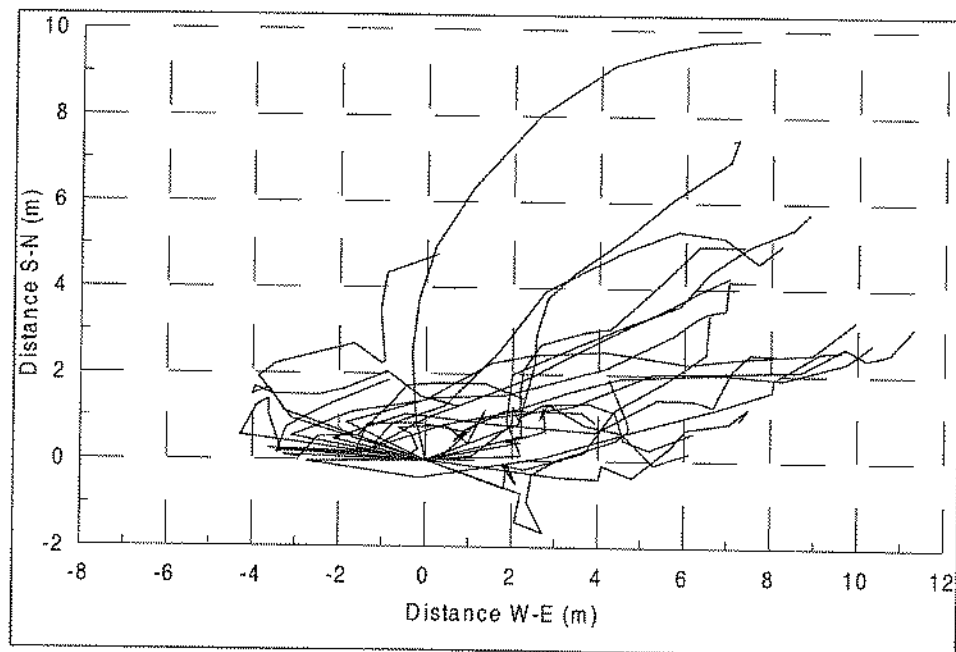

Fig. 2: Trajectories of fish food driven by currents for selected 24-hour measurements (21 June, 2000), if the particles were released hourly.

Sl. 2: Poti namišljenih delcev ribje hrane kot posledica tokov med 24-urnimi meritvami 21. junija 2000 in končni položaj teh delcev na morskem dnu. Delci so bili izpuščeni v intervalu ene ure.

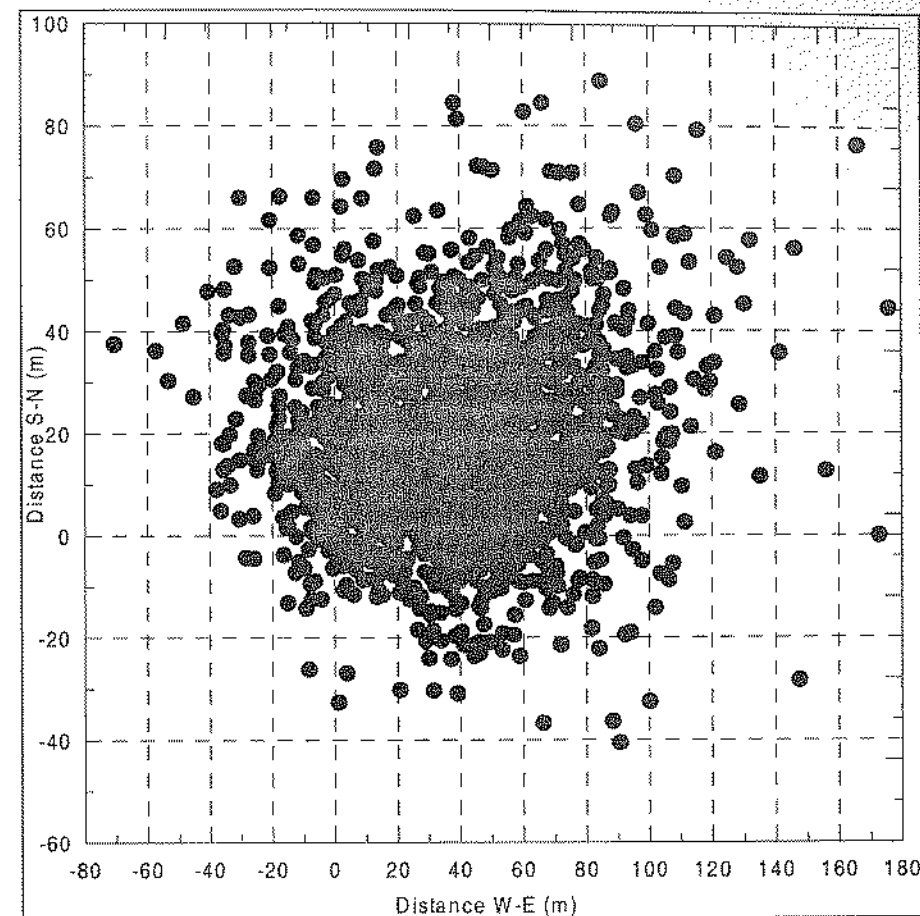

Fig. 3: Simulated distribution of faecal particles on the seabed using trajectories data from the currents measured between April 19 and June 21. The sinking velocity was  $0.64 \pm 0.05 \text{ cm/s}$ .

Sl. 3: Simulacija razporeditve delcev ribjih iztrebkov na morskem dnu. Poti so bile izračunane na osnovi dvomesečnih meritev tokov od 19. aprila do 21. aprila 2000. Hitrost tonjenja je bila  $0.64 \pm 0.05 \text{ cm/s}$ .

Figure 2 displays the trajectories of food particles and their distribution on the sea floor from beneath the centre of a fish farm, if food pellets were released hourly within 24 hours of 21 June 2000. Food particles were spread over a patch covering an area of 16 x 12 m, no more than the fish farm itself. Since the sinking velocity for faecal particles is roughly for an order of magnitude smaller, a similar plot would indicate that the scale of distribution would cover an area around 160 x 120 m. Since during the summer period currents were evenly distributed in all directions, the simulation has been conducted for the spring period, when it was expected that the spread of particles at the sea floor would be larger. Figure 3 shows a simulation of the distribution of food particles if they were released hourly during the late spring period when currents were measured. Sinking food covers an area smaller than 30 x 15 m, indi-

cating that the distribution of faecal particles is within the range of 300 x 150 m.

Measurements of currents on the fish farm site and lab measurements of settling velocity of food pellets and faecal particles have been combined with the simulation of their distribution on the sea floor beneath the fish farm. While many important parameters are missing, such as the variation of density and volume of the particles, it is expected that a reasonable first estimate of patches of food surplus and faecal material has been achieved. Both of them cover an area that is smaller in diameter than a few 100 m. We may therefore consider them as those pointwise pollutants of fish farming that do not affect the ambient of this range. This conclusion, however, is not applicable for the dissolved organic matter generated by fish farming.

## RAZPRŠITEV RIBJE HRANE IN IZTREBKOV NA DNO POD RIBOGOJNICO V PIRANSKEM ZALIVU

Vlado MALAČIČ & Janez FORTE

Nacionalni inštitut za biologijo, Morska biološka postaja, SI-6330 Piran, Fornače 41

E-mail: malacic@mbss.org

### POVZETEK

Iz meritev tokov in laboratorijskih meritev hitrosti tonjenja ribje hrane in delcev ribjih iztrebkov je bila narejena simulacija njihove razpršitve. Pokazalo se je, da višek hrane pokrije površino, manjšo od 30 x 15 m, medtem ko iztrebki ostanejo znotraj meja 300 x 150 m.

**Ključne besede:** marikultura, tokovi, okolje, Piranski zaliv

### REFERENCES

**Forte, J. (2001):** The influence of a fish farm to ecological processes in the inner part of the Bay of Piran (Vpliv gojišča rib na ekološke razmere notranjega dela Piranskega zaliva). B.Sc. Thesis. University of Ljubljana, Biotechnical Faculty, 50 pp.(in Slov.)

**Kundu, P. K. (1990):** Fluid Mechanics. Academic Press, 638 pp.

**Malačič, V. (1991):** Estimation of the vertical eddy diffusion coefficient of heat in the Gulf of Trieste (Northern Adriatic). *Oceanol. Acta*, 14(1), 23-32.

**Ogrin, D. (1995):** The Climate of Slovenian Istria (Podnebje slovenske Istre). Knjižnica Annales, Zgodovinsko društvo za južno Primorsko, 381 pp.

short scientific article  
received: 2003-09-02

UDK 639.32:504.064

## <sup>15</sup>N ENRICHMENT IN FOULING COMMUNITIES INFLUENCED BY ORGANIC WASTE DERIVING FROM FISH FARMS

Sonja LOJEN

"Jožef Stefan" Institute, Department of Environmental Sciences, SI-1000 Ljubljana, Jamova 39

E-mail: sonja.lojen@ijs.si

Dror ANGEL & Timor KATZ

National Centre for Mariculture, Israel Oceanographic and Limnological research, IL-Eilat 88112, POB 1212, North Beach

Manolis TSAPAKIS

Institute of Marine Biology of Crete, GR-71003 Heraklion, POB 2214

Nives KOVAČ & Alenka MALEJ

National Institute of Biology, Marine Biology Station, SI-6330 Piran, Fornače 41

### ABSTRACT

The nitrogen stable isotopic composition of fouling communities colonizing hard substrates at the fish farms and at unpolluted reference locations in N Adriatic (Piran, Slovenia), E Mediterranean (Crete, Greece) and in the Red Sea (Eilat, Israel) was studied. An overall enrichment of the fouling community in <sup>15</sup>N at the fish farms has been detected at two of the three locations, indicating the incorporation of farm-derived particulate nitrogen into the organisms tissues.

**Key words:** fish farm, stable isotope, nitrogen, biofilters, fouling organisms

## ARRICCHIMENTO IN <sup>15</sup>N IN COMUNITÀ DI FOULING INFLUENZATE DA RIFIUTI ORGANICI PROVENIENTI DA ALLEVAMENTI DI PESCI

### SINTESI

L'articolo riporta lo studio della composizione isotopica stabile di azoto in comunità di fouling colonizzanti substrati solidi di allevamenti di pesci e in siti di controllo non inquinati, in Adriatico settentrionale (Pirano, Slovenia), Mediterraneo orientale (Creta, Grecia) e Mar Rosso (Eilat, Israele). Un arricchimento complessivo in <sup>15</sup>N delle comunità di fouling negli allevamenti di pesci è stato riscontrato in due delle tre postazioni, indicando l'incorporazione del particolato di azoto derivante dagli allevamenti nei tessuti degli organismi.

**Parole chiave:** allevamenti di pesci, isotopo stabile, azoto, biofiltri, organismi di fouling



INTRODUCTION

Fish farms release large amounts of soluble inorganic and particulate organic matter (POM) into the marine environment (McGhie et al., 2000). There is, therefore, a large interest in reducing the effluent load to the surrounding waters in order to ease the environmental impact of mariculture. In order to capture and remove effluents released from fish farms, removable hard substrates were deployed near a fish farm, in order to be colonised by filtering organisms.

Stable isotopes of nitrogen were successfully used to trace the dispersion of organic debris and the sources of sedimentary organic matter in marine sediments and in aquaculture systems (Ye et al., 1991; McGhie et al., 2000; Mazzola & Sara, 2001). In organisms, the nitrogen stable isotopic composition ( $\delta^{15}\text{N}$ ) of tissues provides a powerful tool for determination of respective sources of nutrition for consumers and trophic relationships among organisms. In the trophic network among animals,  $\delta^{15}\text{N}$  of their tissues systematically increase on average by 3.4‰ per trophic level (enrichment ranging from 1.3 to 5.3‰; Minagawa & Wada, 1984).

The aim of the present study was to examine the influence of particulate organic nitrogen waste deriving from fish farms on the nitrogen stable isotope composition of fouling communities colonising hard substrates (hereafter referred to as biofilters) adjacent to the fish farm.

MATERIALS AND METHODS

Three study sites were selected: Crete (E Mediterranean), Eilat (Red Sea) and Piran (N Adriatic). Samples of particulate organic matter and fouling communities colonising the biofilters were taken at the fish farms and at reference locations, which had not been affected by aquaculture.

Particulate organic matter (POM) was collected in sediment traps seasonally from autumn 2001 to spring 2003. Samples were filtered through GF/C glass fibre filters and dried in oven overnight at 50 °C.

Samples consisting of entire fouling community on randomly selected biofilters (one per array) were removed from the substrate, dried, pulverised by grinding to particle size below 100µm and subsequently analysed for nitrogen isotope composition.

Nitrogen stable isotope composition ( $\delta^{15}\text{N}$ ) was determined using a continuous flow isotope ratio mass spectrometer Europa 20-20 with ANCA SL preparation module (PDZ Europa Ltd., U.K.). Samples were packed in tin capsules, combusted in elemental analyser and gases produced were separated in a GC column. The results are expressed as relative  $\delta$  values in ‰, i.e. the difference in parts per mil of the isotopic ratios <sup>15</sup>N/<sup>14</sup>N from those of atmospheric nitrogen. Laboratory working

standards (urea and ammonium sulphate solutions with 100 µg/µL N) were calibrated versus IAEA N-1 and IAEA N-2 (NH<sub>4</sub>)<sub>2</sub>SO<sub>4</sub> with  $\delta^{15}\text{N}$  +0.4 and +20.3‰, respectively. Untreated GF/C filters and empty tin capsules were used as blanks. Samples were analysed in triplicate to assess the precision and the reproducibility of the analyses. Standard deviation of the measurement determined on multiple analyses of working standards was generally  $\leq 0.2\%$ , while standard deviation of the samples was generally better than  $\leq 0.3\%$ .

RESULTS AND DISCUSSION

Average  $\delta^{15}\text{N}$  values of particulate organic matter and fouling communities at reference locations and fish farms in Crete, Eilat and Piran are listed in Table 1.

POM was enriched in <sup>15</sup>N at the fish farms compared to the reference locations at all sites, as a consequence of the presence of <sup>15</sup>N enriched organic debris originating from the cages (faeces with average  $\delta^{15}\text{N}$  between 7 and 10.6‰, remains of fish food with  $\delta^{15}\text{N}$  values between 7.6 and 9.7‰). An exceptionally high enrichment in <sup>15</sup>N in POM was detected in Crete, where the large difference cannot be attributed only to the presence of organic waste from the farm, but is partially related to the seasonally dependent differences in nitrogen isotopic composition of plankton, where  $\delta^{15}\text{N}$  values can change by several per mil related to the temperature-dependent nitrogen cycling (Minagawa & Wada, 1984; Sigleo & Macko, 1985; Nakatsuka et al., 1992; Montoya, 1994; Altabet et al., 1999). The high average  $\delta^{15}\text{N}$  value is a consequence of extreme enrichment of POM in <sup>15</sup>N in July 2001, when  $\delta^{15}\text{N}$  values of 11-13 ‰ were determined. Later on the  $\delta^{15}\text{N}$  ranged from 7.2 to 8.6 ‰, yielding a seasonal average of 9.2 ‰.

Tab. 1: Average  $\delta^{15}\text{N}$  values of particulate organic matter and fouling communities at reference locations and fish farms in Crete, Eilat and Piran.

Tab. 1: Povprečne vrednosti  $\delta^{15}\text{N}$  suspendiranih organskih snovi in združbe obrasti na referenčnih lokalitetah in v ribogojnicah na Kreti, v Eilat in Piranu.

Location	$\delta^{15}\text{N}$ of POM [‰]	$\delta^{15}\text{N}$ of fouling community [‰]
CRETE		
Reference	4.2	4.5
Fish farm	10.8 (9.2*)	6.3
EILAT		
Reference	3.6 (3.8*)	3.6
Fish farm	4.8 (4.9*)	5.7
PIRAN		
Reference	5.3 (4.7*)	6.7
Fish farm	5.8 (5.7*)	5.7

\*seasonal averages

Fouling communities at reference locations were enriched in <sup>15</sup>N relative to the POM at all three sites, where the enrichment in Eilat was within the analytical error of the measurements. An enrichment of fouling communities in <sup>15</sup>N at the fish farms relative to the reference locations was observed in Crete and Eilat, while in Piran the opposite occurred. The relation of  $\delta^{15}\text{N}$  of POM to  $\delta^{15}\text{N}$  of fouling communities at the fish farms, however, seems controversial.

The organisms are enriched in <sup>15</sup>N relative to their food sources by at least 1.3‰, depending on the species (Minagawa & Wada, 1984), therefore the observed enrichment can be used for an overall estimation of the sources of nutrition of fouling organisms. Where the organisms are enriched in <sup>15</sup>N relative to the POM, at least part of their nutrition derives from this source. Where the enrichment is very small or even negative, it is obvious that the particulate organic matter does not contribute to the average organisms' diet. Since the colonising communities are composed of different species, only average particulate nitrogen consumption of the whole community colonising the analysed biofilter can be detected.

<sup>15</sup>N-enrichment of organisms at the fish farms relative to those at reference locations indicates that some of the incorporated nitrogen derives from the fish farms, however, its fractions depend mostly on the composition of the colonising community, i.e. relative abundance of non-selective suspension feeders, which are able to ingest and retain nitrogen from particles of various sizes. In Crete, the fouling community at the fish farm is clearly enriched in <sup>15</sup>N relative to the reference location, however, depleted in <sup>15</sup>N relative to the POM. That means that suspension feeders present only a minor fraction of the whole community. Similar situation was observed in Piran.

Figure 1 shows the enrichment of fouling communities relative to the POM at the fish farms and at reference locations. Different enrichments between POM and fouling communities at the fish farms and at reference locations show that the compositions of fouling communities at both locations were obviously different and highly variable from biofilter to biofilter, as well as seasonally, which can be seen from the large range of measured  $\delta^{15}\text{N}$  values. Therefore they cannot be directly compared to each other. However, the overall enrichment of the organisms at the fish farms relative to the reference locations in Crete and Eilat shows that they are enriched in <sup>15</sup>N, i.e. at least part of their food is represented by <sup>15</sup>N enriched POM deriving from the cages.

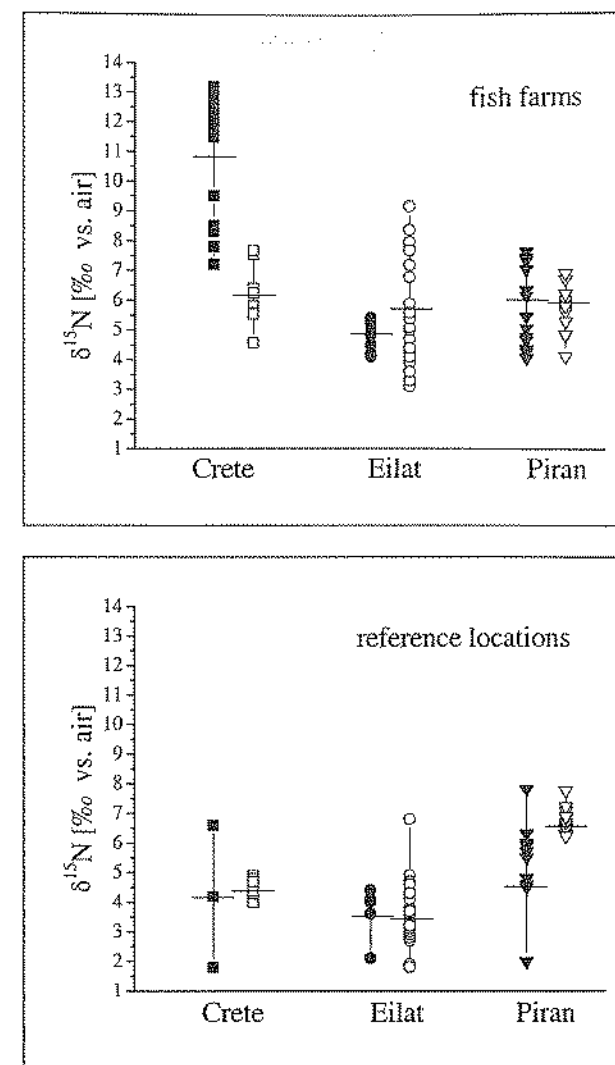

Fig. 1:  $\delta^{15}\text{N}$  of particulate organic matter and fouling communities at the fish farms and at reference locations; solid symbols = POM, open symbols = fouling community. Horizontal bars represent average values of all measurements.

Sl. 1:  $\delta^{15}\text{N}$  suspendiranih organskih snovi in združba obrasti v ribogojnicah in referenčnih lokalitetah; polni simboli = POM, odprti simboli = združba obrasti. Horizontalni stolpčki ponazarjajo povprečne vrednosti vseh meritev.

IZOTOPSKA SESTAVA DUŠIKA V MORSKIH ORGANIZMIH  
V VPLIVNEM OBMOČJU RIBJIH FARM

Sonja LOJEN

Institut "Jožef Stefan", Odsek za znanosti o okolju, SI-1000 Ljubljana, Jamova 39  
E-mail: sonja.lojen@ijs.si

Dror ANGEL &amp; Timor KATZ

National Centre for Mariculture, Israel Oceanographic and Limnological research, IL-Eilat 88112, POB 1212, North Beach

Manolis TSAPAKIS

Institute of Marine Biology of Crete, GR-71003 Heraklion, POB 2214

&amp;

Nives KOVAČ &amp; Alenka MALEJ

Morska biološka postaja, Nacionalni Inštitut za Biologijo, SI-6330 Piran, Fornace 41

## POVZETEK

Analizirali smo izotopsko sestavo dušika v obrastih na umetnih substratih, lociranih v neposredni bližini ribjih farm in na neonesnaženih referenčnih lokacijah v severnem Jadranu (Piran, Slovenija), v vzhodnem Sredozemlju (Kreta, Grčija) in v Rdečem morju (Eilat, Izrael). Na dveh od treh lokacij smo izmerili povečano vsebnost  $\delta^{15}\text{N}$  v organizmih ob ribjih farmah, kar je posledica vgrajevanja izotopsko težjega dušika iz suspendirane snovi, ki se sprošča v okolico iz ribjih kletk.

**Ključne besede:** ribja farma, stabilni izotop, dušik, umetni substrat, organizmi obrasti

## REFERENCES

- Altabet, M. A., C. Piñskaln, R. Thunell, C. Pride, D. Sigman, F. Chavez & R. Francois (1999): The nitrogen isotope biogeochemistry of sinking particles from the margin of the Eastern North Pacific. *Deep-Sea Res Part I*, 46, 655-679.
- Mazzola, A. & G. Sara (2001): The effect of fish farming organic waste on food availability for bivalve molluscs (Gaeta Gulf, Central Tyrrhenian). *Aquaculture*, 192(2-4), 361-379.
- McGhie, T. K., C. M. Crawford, I. M. Mitchell & D. O'Brien (2000): The degradation of fish-cage waste during fallowing. *Aquaculture*, 187, 351-366.
- Minagawa, M. & E. Wada (1984): Stepwise enrichment of <sup>15</sup>N along food chains: Further evidence and the relation between  $\delta^{15}\text{N}$  and animal age. *Geochim. Cosmochim. Acta*, 48, 1135-1140.
- Montoya, J. P. (1994): Nitrogen isotope fractionation in the modern ocean: implications for sedimentary records. In: Zahn, R., T. F. Pedersen, T. F. Kaminski & L. Labeyrie (eds.): *Carbon Cycling in Glacial Ocean: Constraints of the Ocean's Role in the Global Change*. Springer, Berlin, 259-279.
- Nakatsuka, T., N. Handa, E. Wada & C. S. Wong (1992): The dynamic changes of stable isotopic ratios of carbon and nitrogen in suspended and sedimented particulate organic matter during a phytoplankton bloom. *J. Mar. Res.*, 50, 267-296.
- Sigleo, A. C. & S. A. Macko (1985): Stable isotope and amino acid composition of estuarine dissolved colloid material. In: Sigleo, A. C. & A. Hattori (eds.): *Marine and estuarine geochemistry*. Lewis publishers, Chelsea, USA, 29-45.
- Ye, L. X., D. A. Ritz, G. E. Fenton & M. E. Lewis (1991): Tracing the influence on sediments of organic waste from a salmonid farm using stable isotope analysis. *J. Exp. Mar. Biol. Ecol.*, 45, 161-174.

short scientific article  
received: 2003-09-19

UDK 639.32:504.064(262.3-18)

SEDIMENTATION AND COMPOSITION OF PARTICULATE MATTER  
IN A MARINE FISH FARM (GULF OF TRIESTE, NORTHERN ADRIATIC);  
PRELIMINARY RESULTS

Nives KOVAČ &amp; Branko ČERMELJ

National Institute of Biology, Marine Biology Station, SI-6330 Piran, Fornace 41  
E-mail: kovac@mbss.org

Sonja LOJEN

"Jožef Stefan" Institute, Department of Environmental Sciences, SI-1000 Ljubljana, Jamova 39

## ABSTRACT

Composition and sedimentation of particulate matter was determined in a fish farm of the Slovenian coastal sea. The average sedimentation rates of TPM, POC and TPN measured in the farm were higher than those on the control site due to food supply to fish and organic waste from fish farming activity. The impact of fish feeding was also evident from the isotopic ( $\delta^{15}\text{N}$  values) and elemental composition (C and N) of sedimented material with higher values in the fish farm area. Changes in composition of particulate matter and sedimentation fluxes were related to feeding regime during the year and seasonal characteristics of the water column.

**Key words:** fish farming, elemental composition,  $\delta^{15}\text{N}$ , sedimentation rate, northern Adriatic

SEDIMENTAZIONE E COMPOSIZIONE DI MATERIA PARTICELLATA IN UN  
ALLEVAMENTO MARINO DI PESCI (GOLFO DI TRIESTE, ADRIATICO  
SETTENTRIONALE); RISULTATI PRELIMINARI

## SINTESI

La composizione e la sedimentazione della materia particellata sono state determinate ad una profondità di otto metri in un allevamento di pesci in acque costiere della Slovenia. I tassi medi di sedimentazione di materia particellata totale (TPM), carbonio organico particellato (POC) e azoto particellato totale (TPN) sono risultati maggiori di quelli rilevati nel sito di controllo, a causa del mangime per pesci. L'impatto del nutrimento di pesci è risultato evidente anche dalla composizione isotopica (valori  $\delta^{15}\text{N}$ ) ed elementare (C, N) del materiale sedimentato, con valori maggiori nell'area dell'allevamento ittico. Variazioni stagionali della materia particellata e flussi di sedimentazione sono stati correlati al regime alimentare durante l'anno e alle caratteristiche stagionali della colonna d'acqua.

**Parole chiave:** allevamento di pesci, composizione di elementi, tasso di sedimentazione, Adriatico settentrionale

INTRODUCTION

The northern Adriatic is an area under significant impact of fish farming activity, which influences the marine environment. Environmental impact is mostly caused by the supply of unconsumed food and fish feces (Hargrave *et al.*, 1993) leading to high sedimentation rates and consequently to anoxic sediments and impoverishment of benthic fauna (Duplisa & Hargrave, 1996; Mazzoia *et al.*, 1999; Karakassis *et al.*, 2000). The water quality is affected both by particulate and solute waste (Pitta *et al.*, 1999), which can influence the phytoplankton growth (Frid & Mercer, 1989; Arzul *et al.*, 1996).

This work is part of a larger study (EU/BIOFAQs project) to investigate the efficiency of biofilters as reducers of negative impacts of marine cage aquaculture. Our study has been carried out in 2001 to determine the seasonal changes in sedimentation fluxes and composition of particulate matter in the fish farm area in comparison to the selected control point.

MATERIALS AND METHODS

The investigated fish farm Lera d.o.o. is one of the two Slovenian farms situated in the coastal waters of Bay of Piran – Gulf of Trieste (northern Adriatic) (Malačič & Forte, *this volume*). The fish (*European Sea-bass*) were fed commercial pelleted fish food (Marico Start Premium). The food input increased from January to spring and with minor deviation at a high level during the summer, followed by a continual decrease until the following spring.

Four arrays of bio-filters were moored along square cages at a distance of approximately 3 m, and this area was selected as a sampling site (Plate I: Fig. 1). On the horizontal array of bio-filters, cylindrical sediment traps with diameter of 7 cm and an aspect ratio of 7 were mounted at depth of 8 m (Fig. 1) to collect sinking particles. Sediment traps were designed to collect four samples simultaneously and were deployed for 24 hours. Similarly, the sedimentation rates were also measured on control site (CL) including control arrays that were deployed approximately 150-200 m from cages in SE direction. During 2001, four samplings were carried out in July, August, September and November.

After the collection, three aliquots of homogenized suspension from two cylinders at each locations were filtered through precombusted Whatman GF/F glass micro-fibre filters. All samples were freeze-dried for 24 hours and weighed. Dried samples were used for analysis of total suspended matter (TSM), particulate organic carbon (POC), total particulate nitrogen (TPN) and isotopic composition (<sup>13</sup>C and <sup>15</sup>N). Total particulate matter was determined gravimetrically. Organic carbon (POC) and total particulate nitrogen (TPN) analyses of the freeze-dried and acid-washed samples (Hedges & Stern,

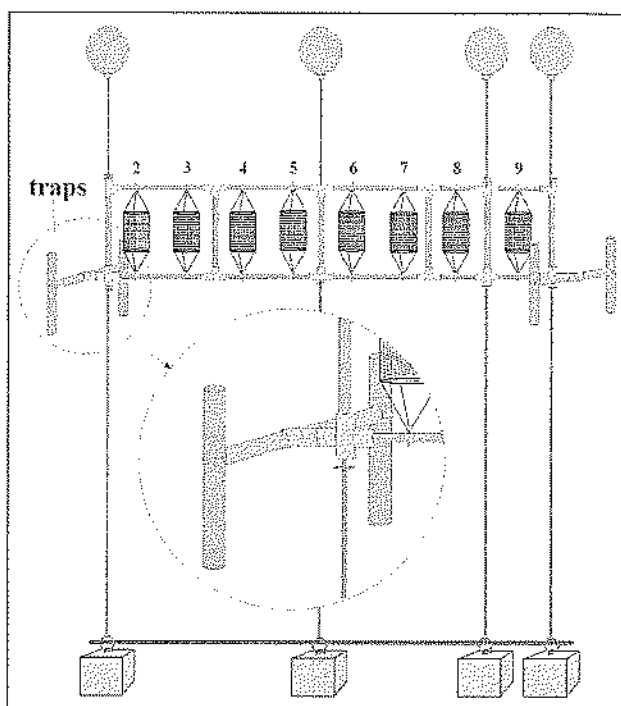

Fig. 1: Scheme of biofilters arrays showing the deployment of sediment traps.

Sl. 1: Shematska predstavitev sistema umetnih substratov (biofiltrrov) ter postavitev sedimentnih pasti.

1984) were performed with Carlo Erba elemental analyser 1108. Analyses of the <sup>13</sup>C and <sup>15</sup>N isotopic composition of the freeze-dried samples were performed with a Europa 20-20 (Europa Scientific) mass spectrometer. Stable-isotope ratios were expressed in δ notation as parts per mil (‰) according to the following relationship:

$$\delta X = [(R_{\text{sample}}/R_{\text{standard}}) - 1] \times 10^3$$

where X is <sup>13</sup>C or <sup>15</sup>N and R is the corresponding ratio <sup>13</sup>C/<sup>12</sup>C or <sup>15</sup>N/<sup>14</sup>N. Standards for <sup>13</sup>C and <sup>15</sup>N are V-PDB and atmospheric N<sub>2</sub> (air), respectively.

RESULTS AND DISCUSSION

The results of elemental composition of sedimented total particulate matter (TPM) from sampling (SL) and control (CL) sites are presented in Table 1. In accordance with our expectations, the material collected in the traps deployed along the fish cages at a depth of 8 m had a higher portion of organic carbon (POC) and total particulate nitrogen (TPN) in comparison to the control site. This enrichment in organic carbon and total nitrogen of particulate matter of SL indicates a contribution of organic waste from partially degraded or uneaten fish food containing high content of organic carbon and nitrogen (Marico Start Premium: 44% C and 9% N). How-

ever, the differences between two sites were more evident during the summer samplings indicating more intense feeding regime of fish.

Tab. 1: Average δ<sup>15</sup>N (‰) values and elemental composition of the sedimented particulate matter at sampling (SL) and control (CL) sites expressed as a percentage of total particulate matter (TPM).

Tab. 1: Povprečne vrednosti δ<sup>15</sup>N (‰) in elementna sestava sedimentirane suspendirane snovi na vzorčišču (SL) in kontrolni postaji (CL), izražena kot odstotek celotne suspendirane snovi (TPM).

	SEDIMENT TRAP SAMPLES							
	Sampling site (SL)				Control site (CL)			
	Jul	Aug	Sep	Nov	Jul	Aug	Sep	Nov
POC (%)	5.95	11.95	2.76	3.39	2.02	8.11	2.15	2.71
TPN (%)	0.71	1.39	0.38	0.51	0.31	1.15	0.31	0.43
C/N (at.)	9.96	10.05	8.36	7.74	7.68	8.08	8.05	7.34
δ <sup>15</sup> N <sub>air</sub> (‰)	7.6	6.3	4.6	4.7	5.8	5.6	1.1	4.6

The average sedimentation rates of TPM, POC and TPN (Figs. 2, 3, 4) reveal higher values on station SL. The same trend, but with higher values, has already been reported for another Slovenian fish farm in the Gulf of Trieste using bottom traps (Kovač *et al.*, 2001). This is in accordance with general observation that the quantity of trapped material increases with depth (Hargrave & Taguchi, 1978). Sedimentation rates of particulate organic carbon determined in July, August, September and November in fish farm were by about 67%, 78%, 48% and 24% higher than those measured at control point. The same was observed for the sedimentation rates of TPN. However, greater differences between both sites during the summer probably result from a higher rate of food addition in this period. The δ<sup>15</sup>N average values of sedimented material at SL also indicated higher supply of fish food and feces during the summer (average 7.0‰) and greater impact of the sediment in the autumn (4.7‰). Comparison of δ<sup>13</sup>C of sedimented matter does not show significant differences, indicating that this parameter is not very suitable for this kind of study (Kovač *et al.*, 2001).

Additionally, the seasonal characteristics (physical, biological) of the water column influenced sedimentation and composition of particulate matter. The late autumn period was characterized by an increased significance of land material (fresh-water supply), resuspension and grater mixing of water body. In the summer period, the greater stability of stratified water column with an impact of sedimented phytoplankton material to sedimented matter was determined.

Compared to data from control site, where all measured values were lower, the composition and sedimentation of particulate matter from fish farm highly reflects the impact of organic material from the fish farming activity (mostly fish food and waste).

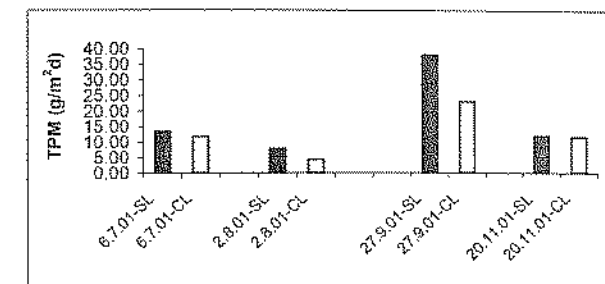

Fig. 2: Sedimentation rate of total particulate matter. Sl. 2: Hitrost sedimentacije celotne suspendirane snovi.

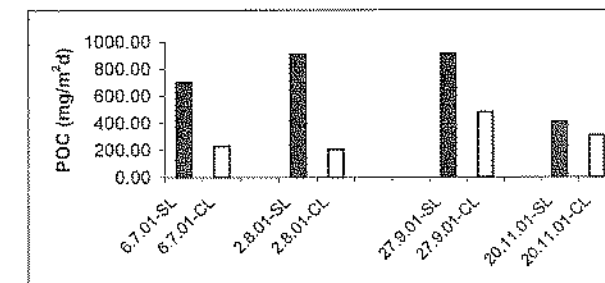

Fig. 3: Sedimentation rate of particulate organic carbon. Sl. 3: Hitrost sedimentacije suspendiranega organskega ogljika.

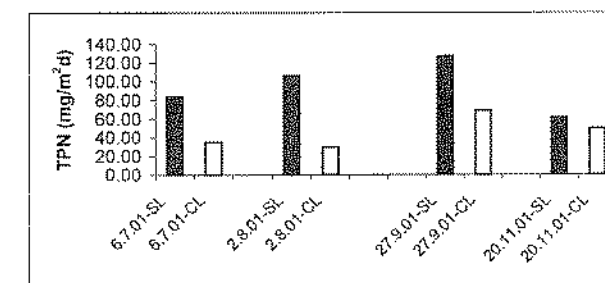

Fig. 4: Sedimentation rate of total particulate nitrogen. Sl. 4: Hitrost sedimentacije celotnega suspendiranega dušika.



## SEDIMENTACIJA IN SESTAVA SUSPENDIRANE SNOVI V OBMOČJU RIBOGOJNICE (TRŽAŠKI ZALIV, SEVERNI JADRAN); PRELIMINARNI REZULTATI

Nives KOVAČ &amp; Branko ČERMELJ

Nacionalni inštitut za biologijo, Morska biološka postaja, SI-6330 Piran, Fornače 41

E-mail: kovac@mbss.org

Sorja LOJEN

Institut "Jožef Stefan", Odsek za znanosti o okolju, SI-1000 Ljubljana, Jamova 39

## POVZETEK

V slovenskem obalnem morju smo v območju ribogojnice ugotavljali sestavo in sedimentacijo suspendirane snovi. Izmerjene povprečne sedimentacijske hitrosti celotne suspendirane snovi, suspendiranega organskega ogljika in celotnega suspendiranega dušika so bile v območju gojišča višje od vrednosti, dobljenih za kontrolno postajo, zaradi prispevka organske snovi, povezane s samo aktivnostjo gojenja (hrana za ribe, feces rib). Velik vpliv hranjenja rib kažejo tudi rezultati izotopske (predvsem  $\delta^{15}\text{N}$  vrednosti) in elementne analize (C in N) sedimentirane snovi. Spremembe pa niso odvisne le od letne sheme hranjenja rib, marveč tudi od sezonskih značilnosti vodnega stolpca.

**Ključne besede:** ribogojnica, elementna sestava,  $\delta^{15}\text{N}$ , hitrost sedimentacije, severni Jadran

## REFERENCES

- Arzul, G., A. Clement & A. Pinier (1996): Effects on phytoplankton growth of dissolved substances produced by fish farming. *Aquat. Living. Resour.*, 9, 95-102.
- Duplisea, D. E. & B. T. Hargrave (1996): Response of meiobenthic size-structure, biomass and respiration to sediment organic enrichment. *Hydrobiologia*, 339, 161-170.
- Frid, C. L. J. & T. S. Mercer (1989): Environmental monitoring of caged fish farming in macrotidal environments. *Mar. Pollut. Bull.*, 20, 379-383.
- Hargrave, B. T. & S. Taguchi (1978): Origin of Deposited Material Sedimented in a Marine Bay. *J. Fish. Res. Board Can.*, 35, 1604-1613.
- Hargrave, B. T., D. E. Duplisea, E. Pfeiffer & D. J. Wildish (1993): Seasonal changes in benthic fluxes of dissolved oxygen and ammonium associated with marine cultured Atlantic salmon. *Mar. Ecol. Prog. Ser.*, 96, 249-257.
- Hedges, J. I. & J. H. Stern (1984): Carbon and nitrogen determinations in carbonate – containing solids. *Limnol. Oceanogr.*, 29, 657-663.
- Karakassis, I., M. Tsapakis, E. Hatziyanni, K. N. Papadopoulou & W. Plaiti (2000): Impact of cage farming of fish on the seabed in three Mediterranean coastal areas. *ICES J. Mar. Sci.*, 57, 1462-1471.
- Kovač, N., B. Vrišer & B. Čermelj (2001): Impacts of net cage fish farm on sedimentary biogeochemical and meiofaunal properties of the Gulf of Trieste. *Annales, Ser. hist. nat.*, 11(1), 65-74.
- Malačič, V. & J. Forte (2003): Distribution of the food surplus and of faecal particles at the seabed below the fish farm (Bay of Piran). *Annales, Ser. hist. nat.*, 13(1), Suppl., 3-8.
- Mazzola, A., S. Mirto, & R. Danovaro, (1999): Initial Fish-Farm Impact on Meiofaunal Assemblages in Coastal Sediments of the Western Mediterranean. *Mar. Pollut. Bull.*, 38, 1126-1133.
- Pitta, P., I. Karakassis, M. Tsapakis & S. Zivanovic (1999): Natural vs. mariculture induced variability in nutrients and plankton in the Eastern Mediterranean. *Hydrobiologia*, 391, 181-194.

short scientific article  
received: 2003-09-02

UDK 639.32:504.064(261.2)

## EARLY COLONISATION OF BIOLOGICAL FILTERS SUSPENDED IN WATERS ADJACENT TO CAGED MARICULTURE ACTIVITY, WEST SCOTLAND

Elizabeth J. COOK &amp; Kenneth D. BLACK

Scottish Association for Marine Science, Dunstaffnage Marine Laboratory, Oban Argyll PA341QA, e-mail: ejc@dml.ac.uk

## ABSTRACT

Patterns in recruitment and colonisation of hard substrata communities in close vicinity to caged mariculture activity were studied in the Lynne of Lorne, west coast of Scotland. Despite the increase in nutrient status and suspended particulate loading near fish farm the larval settlement and the subsequent successional processes did not appear to be seriously affected. Similar invertebrate species were present in both fish farm and control site. A total of 40 invertebrate species, attached to the mesh cylinders were identified over the experimental period and the diversity index was bigger at the fish farm compared to control site.

**Key words:** colonisation, biological filter, sub-littoral macrofauna, mariculture, Scotland

## COLONIZZAZIONE PRECOCE DI BIOFILTRI SOSPESI ADIACENTI AD ATTIVITÀ DI MARICOLTURA IN GABBIE, SCOZIA OCCIDENTALE

## SINTESI

Esempi di reclutamento e colonizzazione di substrati solidi nelle vicinanze di attività di maricoltura in gabbie sono stati studiati in Lynne of Lorne, costa occidentale della Scozia. Malgrado l'incremento nel livello di nutrienti e nel carico di particellato sospeso in prossimità dell'allevamento di pesci, la colonizzazione larvale e i processi successionali a seguire, non sono risultati seriamente disturbati. Specie simili di invertebrati erano presenti sia nell'allevamento di pesci che nella stazione di controllo. Quaranta specie sono state identificate durante il periodo sperimentale attaccate alle maglie dei cilindri e l'indice di diversità è risultato maggiore all'allevamento di pesci che nella stazione di controllo.

**Parole chiave:** colonizzazione, filtri biologici, macrofauna sub-litorale, maricoltura, Scozia

## INTRODUCTION

The colonization of artificial substrata has been widely documented and a large range of marine organisms have been shown to readily settle, recruit and colonise a variety of artificial structures, including plastics, cement and ceramic tiles (Todd & Turner, 1986). Various factors have been identified as contributing to the colonisation of artificial habitats, including both physical and biological factors that can either facilitate or inhibit the survival of organisms (Rodriguez *et al.*, 1993). Food availability and quality is one factor that can play an important role in the length of settlement competence in larval marine invertebrates (Kelly *et al.*, 2000), the nature of the existing biota on the artificial substrata and the subsequent growth and succession of marine organisms that successfully recruit to a particular location (Fleury *et al.*, 2000).

A large proportion of the caged mariculture activity in the U.K. is concentrated on the west coast of Scotland. Only a minority of the nutrients added as feed to the caged systems is removed in the harvest and the remainder is lost into the environment. The annual discharge per ton of salmon is estimated to be 750 kg carbon (Hall *et al.*, 1990), 35.0 kg nitrogen and 7.0 kg phosphorus (Chopin *et al.*, 1999). This loss consists of wasted feed and small feed fragments, faecal particles and dissolved organic and inorganic components. While most of the dissolved components are recycled by the micropelagic food web, particulates either fall to the seabed causing localised seabed enrichment around the cages or remain suspended until consumed by marine organisms or remineralised (reviewed by Pearson & Black, 2001). Whilst a number of studies have found that an increase in organic material can alter the species diversity of soft sediment communities (reviewed by Pearson & Black, 2001), very few have studied hard substrata communities and there is a distinct paucity of information on the influence of enhanced food availability on recruitment and succession in this habitat type.

The aims of this study are to assess patterns in recruitment and colonisation of hard substrata communities in close vicinity to caged mariculture activity.

## MATERIALS AND METHODS

The two study sites were located in the Lynne of Lorne, west coast of Scotland. The first site was approximately 10 m from a commercial Atlantic salmon (*Salmo salar*) fish farm (56°27.09'N; 05°27.68'W) and the second site (termed the 'reference site') was located 500 m north-east of the fish farm (56°27.03'N; 05°27.40'W). The second site was located in an area outwith the influence of the enriched water source but within similar hydrological conditions. The farm con-

sisted of 12 circular net cages (25 m diameter and 22 m depth) and the biomass of the fish farm site averaged 650 tonnes over the 6 month experimental period.

Black square mesh (NETLON™; mesh diameter 25 mm) was formed into a cylindrical shape (500 mm height; 250 mm diameter) and mounted on a rectangular support frames. Each frame held eight randomly attached cylinders at a distance apart of 250 mm. Four frames were deployed at the fish farm (FF) and the reference site (RS) on 18 June 2001. The frames were held vertically in the water column by anchor weights and buoys and oriented perpendicular to the predominant current direction at a depth of 8 m. Temperature loggers (Tinytag™) were attached to the support frames at both experimental sites. Seawater temperature was recorded on a daily basis.

Mesh cylinders were sampled monthly between July and December 2001, with the exception of November 2001, when storms prevented sampling. At each sampling time, four cylinders were randomly selected at each site, one from each frame. The fouling community was assessed by identification to the lowest possible taxon. The abundance of individual organisms attached to the cylinders was recorded. Distinct colonies of each colonial species were counted as one individual. After taxonomic assessment, the biomass of each dominant group of fouling organisms and the biomass of the materials remaining on the mesh was calculated by drying the samples and 3 sub-samples of the mesh (150 x 150 mm) at 45 °C until constant dry weight. The biological material was then combusted at 450 °C for 5 hours to obtain the ash free dry weight (AFDW).

Community structure was described by calculating the total abundance and biomass of individuals, the total number of species, the total number and biomass of individuals of each species and the Shannon-Wiener diversity index ( $H'$ ). Bartlett's test was used to test for homogeneity of variances (Zar, 1996). Sampling time and site were used as fixed factors in a two-way ANOVA to test for differences in species diversity, abundance and biomass of the dominant species between the treatments (MINITAB, Release 13.32 for Windows). The Tukey multiple comparison test was used to assess where significant differences occurred.

## RESULTS AND DISCUSSION

During the experimental period (July to December 2001), seawater temperature at the sites ranged from a maximum of 12.8 °C in August 2001 to a minimum of 9.1 °C in December 2001.

The total biomass of macrofauna increased significantly over the experimental period and the biomass was significantly higher at the FF compared with the RS ( $p < 0.05$ ;  $F = 7.69$ ) (Fig. 1a, Plate 1: Figs. 4a, b). The significant increase in biomass ( $p < 0.001$ ;  $F = 348.5$ ),

particularly in the first 4 months after deployment was primarily due to an increase in the biomass of the ascidian, *Asciella aspersa*, at the both the FF and RS. *A. aspersa* accounted for a high percentage of the total biomass attached to the panels at all the sampling times, with the exception of the first 2 sampling periods (Plate II, Fig. 11). In the first two months, the hydroid, *Obelia longissima* accounted for the highest proportion of the total biomass at both sites. Other species, including the non-native caprellid, *Caprella mutica* ( $p < 0.001$ ;  $F = 81.39$ ) and the bivalve, *Mytilus edulis* ( $p < 0.01$ ;  $F = 161.73$ ) were recorded at a significantly higher biomass at the FF compared to the RS at each sampling time throughout the experimental period.

A statistically higher number of individuals were observed on the mesh cylinders at the FF site compared to the RS over the experimental period ( $p < 0.001$ ;  $F = 96.36$ ) (Fig. 1b). This difference was due to higher numbers of *C. mutica* and *M. edulis* at the FF, particularly in months 3 and 4. These species accounted for a high percentage of the total number of individuals attached to the structures at these two sampling times.

A total of 40 species were identified over the experimental period attached to the mesh cylinders. The Shannon-Wiener diversity index ( $H'$ ) for the macrofaunal communities attached to the mesh cylinders indicated a significant increase ( $p < 0.001$ ,  $F = 98.09$ ) in diversity over the first 2 months after deployment, followed by a plateauing in species diversity for the remainder of the experimental period at both the FF and the RS. The diversity index, however, was higher at the FF compared to the RS at each sampling time, although this difference was only significant in the first month (July 2001) ( $p < 0.05$ ,  $F = 8.47$ ).

A number of key observations can be made from the results of this study:

1. Despite the increase in nutrient status and suspended particulate loading that might be expected in the effluent stream from a large fish farm, larval settlement and the subsequent successional processes did not appear to be negatively affected in this study, as shown by the comparatively high biomass at the FF and the similar species diversity at the 2 experimental sites.

2. As similar species were present on both sites there is no evidence that proximity to the farm excludes sensitive taxa. The main difference between the sites was the higher numbers of *C. mutica* and *M. edulis* at the FF. It is thought that the main mode of introduction for *C. mutica* is in association with aquaculture activities,

which might explain its increased abundance near to the fish farm compared to the reference site.

3. The presence of the farm does appear to be able to influence the biomass of hard substrate macrofauna inhabiting structures in close proximity to the farm and, therefore, further study is required in terms of a) their potential in reducing the environmental output of nutrients from the farm and/or b) the use of the farm as a nutrient source for growing a secondary aquaculture crop.

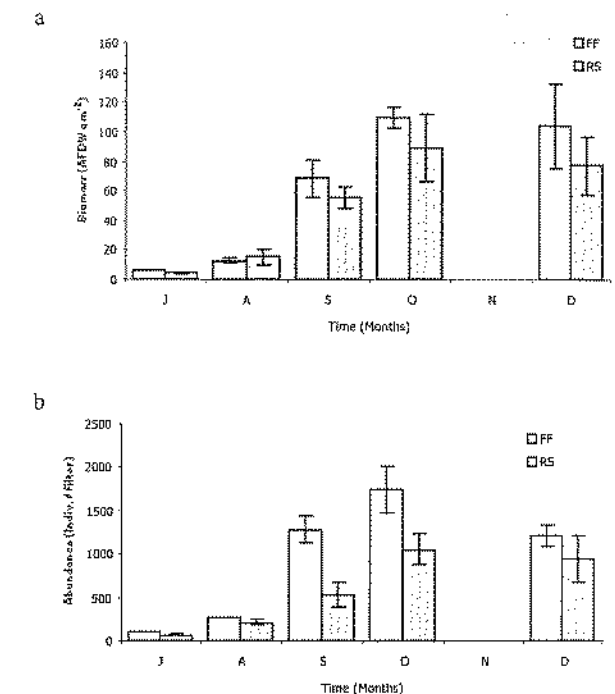

Fig. 1. Biomass (AFDW g m<sup>-2</sup>) (a) and abundance (No. individuals cylinder<sup>-1</sup>) (b) of macrofauna on mesh cylinders at the fish farm (FF) and reference site (RS) in the Lynne of Lorne, west Scotland at the monthly sampling periods (July – December 2001). Mean values ( $n = 4$ ) and standard deviations (error bars) are shown. Sl. 1: Biomasa (AFDW g m<sup>-2</sup>) (a) in abunanca (No. osebkov cilinder<sup>-1</sup>) (b) makrofavne na biofiltrih ob ribogojnici (FF) in na referenčni postaji (RS) v Lynne of Lorne (zahodna Škotska) na posameznih mesečnih vzorčevanjih (Julij – December 2001). Prikazane so povprečne vrednosti ( $n = 4$ ) in standardne deviacije.

ZGODNJE PORAŠČANJE BIOFILTRŌV, VISEČIH V MORJU OB RIBOGOJNICI  
NA ZAHODNEM ŠKOTSKEM

Elizabeth J. COOK &amp; Kenneth D. BLACK

Scottish Association for Marine Science, Dunstaffnage Marine Laboratory, Oban Argyll PA341QA, e-mail ejc@dml.ac.uk

## POVZETEK

V kraju Lynne of Lorne na zahodnem škotskem obrežju sta avtorja preučevala vzorce naseljevanja združb obrasti na trdi podlagi v neposredni bližini marikulturnih kletk. Kljub povečanemu hranilom in suspendiranim snovem v bližini ribogojnice se zdi, da proces naselitve ličink in kasnejše sukcesije ni bil resneje prizadet. Tako v ribogojnici kot na kontrolni postaji so bile zabeležene podobne vrste nevretenčarjev. V eksperimentalnem obdobju je bilo identificiranih 40 vrst nevretenčarjev, pričvrščenih na mrežaste cilindre. Diverzitetni indeks je bil večji v ribogojnici kot na kontrolni postaji.

**Ključne besede:** poraščanje, biofiltri, sublitoralna favna, marikultura, Škotska

## REFERENCES

- Chopin, T., C. Yarish, R. Wilkes, E. Belyea, S. Lu & A. Mathieson (1999): Developing *Porphyra* / salmon integrated aquaculture for bioremediation and diversification of the aquaculture industry. *J. Appl. Phycol.* 11, 463-472.
- Fleury, B. G., J.C. Coll, E. Tentori, S. Dugesne & L. Figueiredo (2000): Effect of nutrient enrichment on the complementary (secondary) metabolite composition of the soft coral *Sarcophyton ehrenbergi* (Cnidaria : Octocorallia: Alcyonaceae) of the Great Barrier Reef. *Mar. Biol.* 136, 63-68.
- Hall, P. O. J., L. G. Anderson, O. Holby, S. Kollberg & M-O Samuelsson (1990): Chemical fluxes and mass balances in a marine fish cage farm. *J. Carbon. Mar. Ecol. Prog. Ser.* 61, 61-73.
- Kelly M. S., A. J. Hunter, C. L. Scholfield & J. D. McKenzie (2000): Morphology and survivorship of larval *Psammechinus miliaris* (Gmelin) (Echinodermata : Echinoidea) in response to varying food quantity and quality. *Aquaculture* 183, 223-240.
- Pearson T. H. & K. D. Black (2001): The environmental impacts of marine fish cage culture. Sheffield Academic Press, Sheffield, pp.1-31.
- Rodriguez S. R., F. P. Ojeda & N. C. Inestrosa (1993): Settlement of benthic marine invertebrates. *Mar. Ecol. Prog. Ser.* 97, 193-207.
- Todd C. D. & S. J. Turner (1986): Ecology of intertidal and sublittoral cryptic epifaunal assemblages. I. Experimental rationale and the analysis of larval settlement. *J. Exp. Mar. Biol. Ecol.* 99, 199-231.
- Zar J. H. (1996): Biostatistical analysis. In: 3<sup>rd</sup> Edition. Prentice Hall International, Englewood Cliffs, NJ.

short scientific article  
received: 2003-09-05

UDK 639.37.5:504.064(262.3-18)

SUSPENDED BIOFILTERS: SUCCESSION OF FOULING COMMUNITIES  
IMMEDIATELY ADJACENT TO A FISH CAGE AND CONTROL LOCATION

Aleksandra FRUMEN, Borut VRIŠER &amp; Alenka MALEJ

National Institute of Biology, Marine Biology Station, SI-6330 Piran, Fornače 41

E-mail: malej@mbss.org

## ABSTRACT

Biofouling succession on the suspended artificial surfaces was studied in the Bay of Piran (northern Adriatic) near a fish farm and at the control location. The novel fouling community was analysed qualitatively and quantitatively. Initially, benthic Algae colonized the artificial surfaces and dominated fouling community near the fish cage; Algae, Bryozoa and Hydrozoa prevailed on control site surfaces. Later succession-settlers were mostly suspension-feeders (hydroids, bivalves, polychaete worms, bryozoans, ascidians), which occupied the artificial surfaces on both sites. After five months, the surfaces were overgrown predominantly by the bryozoan *Schizobrachiella sanguinea*, which was later replaced by the serpulid polychaetes (mainly *Serpula vermicularis*).

**Key words:** biofouling, successions, fish farm, Adriatic Sea

BIOFILTRI SOSPESI: SUCCESSIONI DI COMUNITÀ DI FOULING IMMEDIATAMENTE  
ADIACENTI GABBIE DI PESCI E SITI DI CONTROLLO

## SINTESI

Nella baia di Pirano (Adriatico settentrionale) sono state studiate successioni di bio-fouling su superfici artificiali sospese in prossimità di un allevamento di pesci e di un sito di controllo. Le neo-comunità di fouling sono state analizzate sia qualitativamente che quantitativamente. Durante un primo stadio alghe bentoniche hanno colonizzato le superfici artificiali e dominato la comunità del fouling prossima alla gabbia di pesci. Sulle superfici del sito di controllo sono prevalsi alghe, briozoi ed idrozoi. In fasi successive le superfici di entrambi i siti sono state colonizzate da organismi filtratori (idrozoi, bivalvi, policheti vermiformi, briozoi, ascidiacei). Dopo cinque mesi le superfici erano ricoperte in prevalenza dal briozoo *Schizobrachiella sanguinea*, successivamente sostituito da policheti serpulidi (principalmente *Serpula vermicularis*).

**Parole chiave:** bio-fouling, successioni, allevamento di pesci, Mare Adriatico



## INTRODUCTION

As a rule, pollution originating from open water fish farming exceeds the local purifying capacity of the marine environment. Several solutions were proposed to reduce fish farm impacts and to enhance the auto-purifying capacity of the sea, such as deployment of artificial reefs (review in Spanier & Angel, 1999; Angel, 2001; Black et al., 2001; Hughes, 2001).

To provide surface for bio-fouling community that would enhance natural uptake of the fish farm wastes we deployed suspended artificial structures near fish cages in the moderately eutrophic Bay of Piran (northern Adriatic). Attached flora and fauna are assumed to utilise dissolved and particulate wastes released by farmed fish depending on the structure of the fouling community. Therefore, a study was carried out on succession of fouling communities on suspended structures in the immediate vicinity of fish cages compared to control location.

## MATERIALS AND METHODS

Our study was conducted in the Bay of Piran (see figure 1 in Malačič & Forte, *this volume*) where two fish farms produce about 100 tons of European seabass (*Morone labrax*) and gilthead seabream (*Sparus auratus*) annually. The artificial structures consist of plastic mesh (2 x 2 cm openings) rolled into cylindrical bio-filters (BFs) with a total surface of 0.5 m<sup>2</sup>, supporting the frames, floats and anchor weights (Plate I: Fig. 2). We deployed four arrays consisting of 11 BFs at each location (close to fish farm and control) (Plate I: Fig. 1) at depths ranging from 5 to 11 m. Field surveys of BF and removal for laboratory analysis were carried out 3-4 times yearly from 2001 to 2003. BFs were photographed under water and then removed for further laboratory analysis consisting of taxonomic analysis of fouling community, wet and dry mass measurements, including carbon and nitrogen contents.

## RESULTS AND DISCUSSION

Artificial structures were located in the photic zone and the initial colonisation after a monthly immersion of BFs was dominated by autotrophs at both, fish cage and control site. The main taxa were algae (6 species of Chlorophyceae and Rhodophyceae) and diatoms, embedded in mucilage. Fouling fauna was represented by small bryozoan colonies (1 species), Hydroidea (3 species) and Bivalvia. On average, 38% (38.3±1.2) of BFs surface was covered by fouling organisms at fish farm site compared to significantly higher coverage (73.3±7.2) on the control site. Algal fouling prevailed on fish farm site (22.5±2.0% of total surface) compared to 8.3±3.1% on the control site, where hydroids (49.2±3.1)

and bryozoans (15.8±1.2%) dominated the early colonisation (Plate I: Figs 6a, 6b).

Algae covered, on average, 29.1±6.8 and 9.5±4.4% of BFs surface at fish farm and control locations, respectively, after three months of the BFs immersion. BFs were nearly completely overgrown with fouling communities: 94.1±2.0% coverage was observed at fish farm and 95.0±1.8 on the control site. Fouling fauna was still dominated by hydroids and bryozoans, the latter covering 35.9±9.0 and 67.2±10.2% of BFs surface at fish farm and control locations, respectively.

Algae coverage decreased to 13.4±4.2 and 1.2±1.5% (fish farm and control site) after five months of immersion, while macrofauna, now consisting of 6 main sedentary groups (Hydroidea, Cirripedia, Ascidiacea, Bivalvia, Polychaeta, Bryozoa) prevailed. However, only one bryozoan species *Schizobrachiella sanguinea* covered over 80% of BFs surface at both localities. Nearly 2 years after the immersion of BFs, serpulid polychaetes, mostly *Serpula vermicularis*, dominated fouling communities at both localities.

Vagile fauna, associated with BFs, was less important and included mainly Crustacea (Amphipoda, Gammaridea, Decapoda, Anisopoda), motile Polychaeta and opisthobranch molluscs.

A total of 38 sedentary taxa were identified over the experimental period (nearly 2 years) attached to BFs, of which 26 were common to both localities (Tab. 1). More taxa were registered at fish farm (36) than on control site (28) (Plate II: Figs 12, 13).

Described pattern of colonisation of BFs generally conforms to the successions on artificial substrates observed in other studies in the northern Adriatic (Bressan, 2001) and elsewhere (Cook, 2001). The only exception was the low abundance of mussels and barnacles that seemed to be unsuccessful settlers on BFs.

## CONCLUSIONS

The initial 5 months after BFs deployment were characterised by macro algae (Chlorophyceae, Rhodophyceae) settlement that covered comparatively larger surfaces on bio-filters deployed near the fish cage. Hydrozoans and Bryozoa were also successful colonisers of BFs during this initial stage, particularly bryozoan *Schizobrachiella sanguinea* outcompeted other species for space. Serpulid polychaetes dominated the fouling community at both localities after over a year of immersion.

Similar taxa developed at fish farm and control localities but number of taxa recorded on bio-filters deployed on fish farm site was higher, indicating that the enriched environment enhanced the settlement of various organisms.

Tab. 1: Taxonomic structure of flora & sedentary fauna of bio-filter fouling communities at fish farm and at control site between 2001 and 2003.

Taxa	Fish farm	Control site
<b>Algae</b>		
<i>Enteromorpha</i> sp.	+	+
<i>Cladophora</i> sp.	+	-
<i>Antithamnion</i> sp.	+	+
<i>Polysiphonia</i> sp.	+	+
<i>Ceramium</i> sp.	+	+
<i>Champia</i> sp.	-	+
<b>FAUNA</b>		
<i>Spongiaria</i> spp.	+	-
<b>Hydroidea</b>		
<i>Obelia geniculata</i>	+	+
<i>Campanopsis</i> sp.	+	+
<i>Kirchenpaueria</i> sp.	+	+
<i>Eudendrium</i> sp.	+	+
<i>Gonothyrea</i> sp.	+	-
<b>Bivalvia</b>		
<i>Chlamys multistriata</i>	+	+
<i>Chlamys varius</i>	+	+
<i>Hiatella arctica</i>	+	+
<i>Barbatia barbata</i>	+	-
<i>Mytilus galloprovincialis</i>	+	+
<i>Ostrea edulis</i>	+	+
<i>Anomia ephippium</i>	+	+
<i>Pericardium</i> sp.	+	-

Tab. 1: Taksonomska struktura flore in sesilne favne v združbi obrasti na biofiltrih ob ribogojnici in na kontrolni postaji v obdobju 2001-03.

Taxa	Fish farm	Control site
<b>Polychaeta</b>		
<i>Serpula vermicularis</i>	+	+
<i>Pomatoceros triqueter</i>	+	+
<i>Hydroides helmatius</i>	+	-
<i>Mercierella enigmatica</i>	+	+
<i>Spirorbis pagenstecheri</i>	+	+
<i>Salmacina incrustans</i>	+	-
<i>Polydora</i> sp.	+	-
<b>Cirripedia</b>		
<i>Balanus balanus</i>	+	+
<b>Bryozoa</b>		
<i>Adeona haeckeli</i>	+	-
<i>Bugula neritina</i>	+	+
<i>Lichenopora radiata</i>	+	+
<i>Schizobrachiella sanguinea</i>	+	+
<i>Tubulipora</i> sp.	+	-
<b>Ascidiacea</b>		
<i>Styela plicata</i>	+	-
<i>Polycarpa pomaria</i>	+	+
<i>Botryllus schlosseri</i>	+	+
<i>Microcosmus vulgaris</i>	+	+
<i>Asciidiella aspersa</i>	+	+
<i>Phallusia</i> sp.	-	+

## SUKCESIJE ZDRUŽB OBRISTI NA LEBDEČIH BIOFILTRIH V NEPOSREDNI BLIŽINI RIBOGOJNICE IN NA KONTROLNI LOKACIJI

Aleksandra FRUMEN, Borut Vrišer & Alenka MALEJ

Nacionalni inštitut za biologijo, Morska biološka postaja, SI-6330 Piran, Fornače 41

E-mail: malej@mbss.org

## POVZETEK

V obdobju 2001-2003 smo v Piranskem zalivu raziskovali sukcesije biološke obrasti na lebdečem umetnem substratu plastičnih mrež (biofiltrih) v neposredni bližini ribogojnice in na kontrolni lokaciji. Prvi naseljenci so bile bentoške alge (predvsem ob ribogojnici) in hidroidi (predvsem na kontrolni postaji). Poznejše sukcesije združb obrasti obeh lokacij je oblikovala zlasti suspenziofaga sedentarna favna školjk, polihetnih črvov, hidroidov, mahovnjakov in kozolnjakov. Po petih mesecih so prevladali mahovnjaki vrste *Schizobrachiella sanguinea*, po skoraj dveh letih pa polihetni črvi (*Serpula vermicularis*).

**Ključne besede:** obrast, sukcesije, ribogojnica, Jadransko morje

## REFERENCES

- Angel, D. (2001):** A review of biofiltration processes as used in waste management. In: A review of the environmental impacts of marine cage aquaculture, processes of biofiltration relevant to impact mitigation, the biological properties of marine invertebrates relevant to biofiltration and biofouling on artificial structures. BIOFAQs Ann. Rep., Techn. Annex, p. 31-45.
- Black, K. D., M. D. J. Sayer, E. Cook, D. Angel, E. Spanier, I. Karakasis, A. Malej, K. Collins, H. Pickering, S. Whitmarsh & S. Lojen (2001):** BIOFAQs – BIOfiltration and Aquaculture: an evaluation of substrate deployment performance with mariculture developments. Cahier Options Mediterraneeennes, 55, 205-207.
- Bressan, G. (2001).** Studies on the artificial reefs on the ridge of S. Croce. Rep. INTERREG II, 323 pp.
- Cook, E. (2001):** A review of biofouling on artificial substrates. BIOFAQs Ann. Rep., Techn. Annex, p. 87-101
- Hughes, D. (2001):** A review of biological filtration by marine invertebrates. In: A review of the environmental impacts of marine cage aquaculture, processes of biofiltration relevant to impact mitigation, the biological properties of marine invertebrates relevant to biofiltration and biofouling on artificial structures. BIOFAQs Ann. Rep., Techn. Annex, p. 49-77.
- Spanier, E. & D. Angel (1999):** Crosshatch artificial reefs to reduce organic enrichment caused by commercial net fish farming in Gulf of Eilat, Israel. Israeli Ministry for the Environment, The Marine and Coastal Dept., 42 pp.

short scientific article  
received: 2003-09-04

UDK 639.32:504.064(262-11)

## CAN OPEN WATER BIO-FILTERS BE USED FOR THE REDUCTION OF THE ENVIRONMENTAL IMPACT OF FINFISH NET CAGE AQUACULTURE IN THE COASTAL WATERS OF ISRAEL?

*Ehud SPANIER, Anat TSEMEL, Hadas LUBINEVSKI, Ayalon ROITEMBERG, Amir YURMAN & Stephen BREITSTEIN*  
The Leon Recanati Institute for Maritime Studies and Department of Maritime Civilizations, University of Haifa,  
IL-Haifa 31905, Mount Carmel  
E-mail: spanier@research.haifa.ac.il

*Dror ANGEL, Noa EDEN & Timor KATZ*  
National Centre for Mariculture, Israel Oceanographic and Limnological research, IL-Eilat 88112, POB 1212, North Beach

## ABSTRACT

*The use of open water artificial substrates, "bio-filters" (BFs), "Mussel lines" and bivalves in perforated plastic boxes, to reduce the organic output of pen fish farms, was examined in the coastal waters of Israel, the Red Sea and the Mediterranean. The most substantial finding was that species richness and diversity, coverage and biomass of sessile invertebrates and macroalgae were significantly greater on BFs near the fish farm compared to those from a reference site. This indicates that the food used by the fouling organisms on the BFs derived from fish cages.*

**Key words:** aquaculture, northern Red Sea, south-eastern Mediterranean, organic loading, particulate and dissolved organic matter, bio-filtration

## È POSSIBILE USARE BIO-FILTRI IN MARE APERTO ALLO SCOPO DI RIDURRE L'IMPATTO AMBIENTALE CAUSATO DA PISCICOLTURA IN GABBIE IN ACQUE COSTIERE ISRAELIANE?

## SINTESI

*L'uso di substrati artificiali, ossia "bio-filtri" (BFs), "linee di mitili" e bivalvi in scatole di plastica perforate in mare aperto, allo scopo di ridurre l'output organico di piscicoltura in gabbie, è stato esaminato in acque costiere israeliane, sia in Mar Rosso che Mediterraneo. La scoperta più notevole riguarda la ricchezza e diversità di specie, la copertura e la biomassa di invertebrati sessili e macroalghe, che si sono rivelate e maggiori su bio-filtri prossimi all'allevamento ittico che su quelli nei siti. Tale risultato indica che il nutrimento usato da organismi del fouling su bio-filtri deriva dalle gabbie di pesci.*

**Parole chiave:** acquacoltura, Mar Rosso settentrionale, Mediterraneo sud-orientale, carico organico, materia organica disciolta e particellata, bio-filtrazione

## INTRODUCTION

Two pen fish farms in Eilat, northern Gulf of Aqaba, Red Sea, produce ~2500 metric tons of fish, mainly gilthead sea-bream, *Sparus aurata*, annually. The remains of the fish food and secretions are released to the naturally oligotrophic marine environment. These loadings can cause algal blooms, sediment anoxia and reduce benthic biodiversity. There are disputed claims that the deterioration of the coral reef reserve (the only one in Israel) ~7 km south-west of the farm should be blamed, at least partially, on the fish farms (Atkinson et al., 2001). Another farm is located in the opening of the port of Ashdod, the southern Mediterranean coast of Israel and produces 600 metric tons of *S. aurata*, annually. The present study is an attempt to reduce these environmental impacts by using sessile biota, natural settlement on open water artificial substrates ("bio-filters", "Mussel lines" and perforated plastic boxes). The attached fauna that filter the water surrounding the cages are assumed to utilize the organic output of the cages for their own growth and are subsequently removed.

## MATERIALS AND METHODS

## Open water bio-filters

In June 2001, four experimental arrays of bio-filters (BFs) consisting of 11 plastic (NETLON) vertical 25 mm mesh cylinders, 25 x 50 cm each, were deployed at two sites, at depths of 5-14 m. One, the fish farm site (FF), was adjacent to ARDAG fish farm (34°58'40"E, 29°32'45"N) and the other, a reference site (R), was located 300 m west of it.

This study will refer only to the 8 BFs deployed at 8m depth (Plate I: Figs. 5a, b). In addition to bimonthly visual and video censuses of all the BFs, divers censused the number of sea urchins in each BF.

Four BFs from each site were randomly sampled between September 2001 to June 2002 and sub-samples, constituting 20% of the surface area of each mesh, were cut and photographed. Sub-samples were analyzed for species composition, coverage and weight.

Sessile biota was identified to the lowest taxonomic level possible and species richness was determined. Species-specific cover was determined (following Foster et al., 1991) by counting the number of mesh cross points covered by each taxa, divided by the total number of mesh cross points examined (144).

## Mussel lines

In June 2002, eight 1 m pieces of mussel line (loosely woven rope used by professional mussel fishermen in Scotland), were deployed at 8 m depth on each of the above BFs arrays, on both sites (FF and R) in

an attempt to recruit natural bivalves. Each mussel line was weighed down using a small lead weight, attached to its edge. Four mussel lines were randomly sampled bimonthly. Sessile biota was identified to the lowest taxonomic level possible and the biota was weighed.

## Mono-species bio-filters

Two species of bivalves, the pearl oyster, *Pinctada radiata*, and the spiny oyster, *Spondylus spinosus*, both Lessepsian migrants from the Red Sea (Spanier & Galil, 1991), were collected in the Mediterranean coastal waters of Israel. They were deployed, in groups of 25 specimens each, in separate 60x40x40 cm perforated plastic boxes, 2-4 m under the water surface beside the cages of the fish farm in the opening of the Port of Ashdod (FA), at a reference site inside this port (RA) and at a control site located in a ship wreck (CSW) off southern Haifa (140 km north of Ashdod) where these bivalves grow naturally. Survival and growth were monitored periodically.

## RESULTS AND DISCUSSION

## Open water bio-filters

A variety of sessile organisms rapidly colonized BFs at both sites (Plate II). Red algae (especially *Jania adhaerens*), sponges (especially *Mycale fistulifera*, see Plate II: Fig. 7), sea anemones, serpulids, polychaets and bivalves were the dominant taxa on the FF substrata. Sponges, tunicates, bryozoans, and bivalves were the dominant sessile taxa at R site. Stony corals appeared on BFs at both sites (Plate II: Fig. 8). The succession process differed at the two sites. Species richness and diversity, coverage and biomass were significantly greater on BFs from site FF compared to those from site R at all times (Fig. 1) (Plate I: Figs. 5a, b). The ash free dry weight, representing living tissue, continued to accumulate throughout the research period (11 months). *M. fistulifera*, known from laboratory experiments to be a very efficient dead particulate organic feeder (Reiswig, 1974), was the main contributor. The increase of bio-fouling on the BFs at site FF compared to those from site R may indicate that these organisms can potentially utilize the organic output from fish cages, directly or via the food web.

Grazing, by wild fish and mobile macroinvertebrates (such as sea urchins, e.g. Plate II: Fig. 7), may supply an alternative explanation: in site FF, wild mobile organisms have an alternative food source – the organic output from the cages. This artificial nutrition is lacking at site R and may cause greater grazing of the bio-fouling on the BFs there. This seemingly greater grazing of the bio-fouling may result in less biomass on BFs at site R than at FF. However, the finding that the number of sea

urchins censused (between December 2002 and May 2003) was considerably higher on BFs at site FF (mean 0.25 – 0.5 sea urchin / BF / census) than on those from site R (mean 0.0 – 0.1 sea urchin / BF / census) supports the rejection of the grazing hypothesis. Moreover, the study by Lojen et al. (2002) of stable isotopes ( $^{13}\text{C}$ ,  $^{15}\text{N}$ ) in the food of cultured fish, particulate organic matter (POM) and organisms sampled on the BFs, indicated that organisms from the BF were enriched with  $^{15}\text{N}$  compared to POM. Lojen et al. (2002) estimated that 61% of the food used by fouling organisms on the BFs derived from the cages.

Thus the use of open water BFs of this nature to reduce organic load in the marine environment should be considered. Yet the large numbers of surfaces needed may limit the applicability of this method.

## Mussel lines

Algae (mainly *J. adhaerens*) were detected first at site FF and continued to dominate the BFs at this site during the whole study period (12 months). At Site R, they appeared only 6 months later. At this site, *M. fistulifera* (Plate II: Fig. 9) was the dominant species for most of the year. Serpulids appeared at both sites, occasionally in high concentrations. It is interesting to note that there was a negative correlation between the appearance of algae and serpulids, possibly indicating competition in the space between them. Bryozoans, other sponges, tunicates (solitary and colonial), hydrozoans (Plate II: Fig. 9) were also detected on mussel lines at both sites, although in smaller amounts than the taxa discussed above, without significant differences between sites.

Only a small amount of bivalves settled on the mussel ropes. The effect of recruitment from the adjacent fouled BFs should be considered as well as competition for space (taken by earlier and more "aggressive" settlers such as algae, sponges and serpulids) that might have limited the development of bivalves on the mussel lines.

Relatively low levels of bivalves' larvae in the water column in this area may be an alternative/additional explanation for the relatively low recruitment of bivalves to the mussel lines.

## Mono-species bio-filters

Since the depth of the bottom of the cages in the opening of Ashdod port is only 1 m above the muddy bottom, preliminary deployment of the perforated plastic boxes at 6 m depth resulted in a very heavy siltation of the bivalves. Thus a shallower depth was selected for the positioning of the bivalves' boxes.

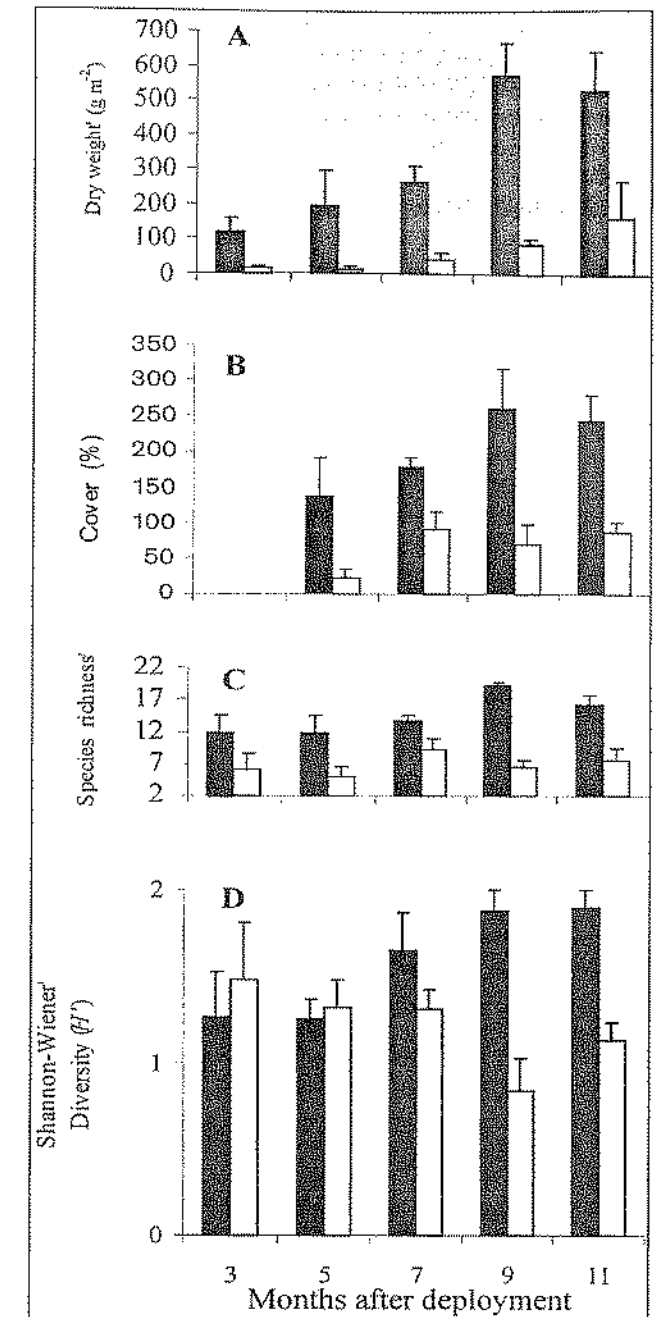

Fig. 1: Characteristics (mean  $\pm$  SD) of epi-biota community on artificial substrata near the fish farm (FF - black columns) and reference site (R - white columns), 3 to 11 months after deployment. (A) Dry weight; (B) Cover percentage; (C) Species richness; (D) Shannon-Wiener Diversity ( $H'$ ).  
Sl. 1: Značilnosti (srednja vrednost  $\pm$  SD) epibiotske združbe na umetnih substratih v bližini morske ribogojnice (FF - črni stolpci) in referenčnih lokalitetah (R - beli stolpci), 3 do 11 mesecev po njihovi postavitvi. (A) Suha teža; (B) Pokrovnost; (C) Vrsta pestrost; (D) Shannon-Wienerjev diverzitetni indeks ( $H'$ ).



In January 2003, several boxes disappeared from Ashdod port during a severe winter storm (9.7 m maximum wave height). Of the remaining *P. radiata* at FA, 65% survived after a year. The survival rates at RA, and CSW were 84% and 33% respectively. The mortality in Ashdod (FA, RA) occurred mostly during the winter, while at the control site (CSW) death occurred mainly during the summer. There was no growth in FA during the summer. During the rest of the year mean growth rates of this species in FA was 4.9 mm/month. Annual mean growth rate was 5.8 and 9.2 mm/month at CA and CSW respectively.

Mass mortality (89%) of *S. spinosus* at FA was observed in the spring and summer. It seems that fish cages located in an opening of a port are not an ideal location for mono-species BFs. The intense water movement due

to ship transport, combined with shallow depth, cause intense siltation. This and the massive growth of algae, tunicates and bryozoans on the bivalves' box and the possible competition with the bivalves may explain the low growth rate and mortality of the bivalves.

#### ACKNOWLEDGEMENT

This study was supported by a grant (Q5RS-2000-30305) from the European Community within the framework of the EU FP-5 project BIOFAQs (BIOfiltration and AQUaculture- an evaluation of hard substrate deployment performance within mariculture developments). A. Yurman, S. and A. Breitstein are acknowledged for the underwater photography.

### ALI JE MOGOČE UPORABITI BIOFILTRIRANJE VODA ZA ZMANJŠEVANJE OKOLJSKEGA VPLIVA MARIKULTURNIH KLETK V OBREŽNIH VODAH IZRAELA?

Ehud SPANIER, Anat TSEMEL, Hadas LUBINEVSKI, Ayalon ROITEMBERG, Amir YURMAN & Stephen BREITSTEIN

The Leon Recanati Institute for Maritime Studies and Department of Maritime Civilizations, University of Haifa,  
IL-Haifa 31905, Mount Carmel  
E-mail: spanier@research.haifa.ac.il

Dror ANGEL, Noa EDEN & Timor KATZ

National Centre for Mariculture, Israel Oceanographic and Limnological research, IL-Eilat 88112, POB 1212, North Beach

#### POVZETEK

V obrežnih vodah Izraela, Rdečega morja in jugovzhodnega Sredozemskega morja so avtorji raziskovali, kako bi z uporabo umetnih substratov, "biofiltriranih" (BFs), "školjčnih vrvic" in školjk v perforiranih plastičnih škatlah, lahko zmanjšali organski izpust iz kletk za vzgojo rib. Najpomembnejša je bila ugotovitev, da je pestrost vrst, pokrovnost in biomasa sesilnih nevretenčarjev in makroalg neprimerno večja na biofiltriranih v bližini marikulturnih kletk kot na referenčnih lokalitetah, kar kaže na to, da je hrana, ki so jo uporabljali organizmi na biofiltriranih, prihajala iz ribjih kletk.

**Ključne besede:** marikultura, severno Rdeče morje, jugovzhodno Sredozemsko morje, organska obremenitev, suspendirane in raztopljene organske snovi, bio-filtriranje

#### REFERENCES

Atkinson, M. J., Y. Birk & H. Rosenthal (2001): Evaluation of pollution in the Gulf of Eilat. Report for the Israeli Ministries of Infrastructure, Environment and Agriculture, 44 pp.  
Foster, M. S., C. Harrold & D. D. Hardin (1991): Point vs. quadrat estimates of the cover of sessile marine organisms. J. Exp. Mar. Biol. Ecol., 146, 193-203.  
Lojani, S., A. Malej, D. Angel, N. Eden, E. Spanier, M. Tsapakis, I. Karakassis, E. Cook & K. Black (2002): Bio-

filtration and aquaculture: a stable isotope study. Sea-farming today and tomorrow. Aquaculture Europe, 2002, Trieste, Italy. European Aquaculture Society, Special Publ. No. 32, p. 306-307.

Reiswig, H. M. (1974): Water transport, respiration and energetics of three tropical marine sponges. J. Exp. Mar. Biol. Ecol., 14, 231-249.

Spanier, E. & B. S. Galil (1991): Lessepsian migration a continuous biogeographical process. Endeavour, 15(3), 102-106.

short scientific article  
received: 2003-09-02

UDK 639.32:504.064(262-11)

### EFFECT OF TIME OF FIRST DEPLOYMENT AND DURATION ON THE SUCCESSION OF BENTHIC ORGANISMS ON BIOFILTERS USED TO MITIGATE IMPACT OF FISH FARMS ON WATER QUALITY IN CRETE

Eugenia APOSTOLAKI, Manolis TSAPAKIS, Tatiana TSAGARAKI, Kostantia PAPADOPOULOU & Ioannis KARAKASSIS

Institute of Marine Biology of Crete, GR-71003 Heraklion, POB 2214

E-mail: jkarak@imbc.gr

#### ABSTRACT

A total of 18 biofilters were deployed in an open coastal bay of Crete, in order to study the efficiency of biofilters using the locally available fouling communities for mitigation of pollution effects by fish farms. Wet biomass, abundance and species diversity of fouling organisms increased with increasing deployment time during all seasons and for all the filters deployed. Shannon diversity index and average taxonomic distinctness found to be quite stable after the first two months of deployment. Multidimensional scaling (MDS) of wet biomass and species abundance revealed biofilters clustering in relation to deployment period, regardless of deployment season.

**Key words:** biofilters, succession, fish farming, Eastern Mediterranean, Crete

### EFFETTO DI PERIODO DEL PRIMO POSIZIONAMENTO E DURATA SU SUCCESSIONI DI ORGANISMI BENTONICI SU BIOFILTRI USATI PER RIDURRE L'IMPATTO DI ALLEVAMENTI DI PESCI SULLA QUALITÀ DELL'ACQUA A CRETA

#### SINTESI

Diciotto biofiltri sono stati posizionati in una baia aperta di Creta, allo scopo di studiare l'efficienza dei biofiltri nell'uso di comunità di fouling disponibili per ridurre gli effetti dell'inquinamento provocato da allevamenti di pesci. La biomassa umida, il numero di specie ed individui degli organismi del fouling sono aumentati con l'aumentare del periodo di impiego dei filtri in tutte le stagioni e per tutti i filtri posizionati. L'indice di diversità di Shannon e la precisione media tassonomica sono risultati abbastanza stabili dopo due mesi di posizionamento. Il metodo "multidimensional scaling" (MDS) applicato alla biomassa umida e all'abbondanza di specie ha rivelato un raggruppamento di biofiltri in relazione al periodo di posizionamento, a prescindere dalla stagione di posizionamento.

**Parole chiave:** biofiltri, successione, allevamento di pesci, Mediterraneo orientale, Creta

INTRODUCTION

Fish farms release a substantial amount of wastes in both particulate and solute forms reaching more than 70% of the nitrogen and phosphorus supplied through fish feed (Holby & Hall, 1991; Hall et al., 1992). The most severe environmental problems affecting other users of the coastal zone could arise from the solute and fine particulate wastes that may be transported at large distance from the farming sites, thus affecting water quality and marine resources over large areas (Pitta et al., 1999). The use of filtering systems based on marine organisms as a means for minimizing these effects has been suggested by various authors in different contexts (Kautsky & Folke, 1989; Neori et al., 2000; Chopin et al., 2001). It has been recently suggested (Angel & Spanier, 2002) that the deployment of biofilters using the locally available fouling communities could provide a mean for mitigation of pollution effects by fish farms. In the present paper, we have investigated the performance of *in situ* biofilters deployed during the warm season of the year (May to November), when most of the wastes are discharged into the marine environment. This paper addresses the issue of colonization of these substrates depending on the time and duration of deployment.

MATERIALS AND METHODS

The area selected for the deployment of biofilters is an exposed coastal bay at eastern part of Crete, characterized by fairly rough weather, ensuring adequate water flushing, and low background concentrations of nutrients and particulate matter. The fish farm operating there has a mean annual production of 1000-1200 tons of European seabass (*Morone labrax*) and gilthead seabream (*Sparus auratus*). Biofilters were constructed of hard plastic net and rolled to a total surface area of 0.5 m<sup>2</sup>. A total of 18 biofilters (BF) were deployed at 6 m distance from the fish cages and 5 m depth from the sea surface (Plate II: Fig. 10). Nine biofilters were deployed in May 2002, three of which were retrieved two months later (July 2002) [code number 2(M-J)- number refers to total duration of deployment in months, and the two letters to deployment and retrieval month respectively]. In July 2002, six new biofilters were deployed. In September 2002, 3 biofilters deployed in May [4(M-S)] and 3 deployed in July [2(J-S)] were retrieved, whereas 3 new biofilters were deployed. In November 2002, all standing biofilters were collected [3 BF 6(M-N), 3 BF 4(J-N) and 3 BF 2(S-N)]. Sampling was made by means of scuba diving. Biofilters were enclosed in plastic bags, to prevent loss of epifauna, and transferred to the laboratory and photographed. Fouling organisms were sorted

and weighed and animals were identified to species level where possible. Differences in community structure were assessed by means of both uni- and multivariate analysis using the PRIMER software package (Clarke & Warwick, 1994). Species abundance and biomass were transformed with log(x+1) and square root respectively, prior to performing multidimensional scaling (MDS).

RESULTS AND DISCUSSION

Wet biomass of fouling organisms increased with increasing deployment time (Fig. 1). The largest increase in biomass was observed on the filters deployed in May between the 4<sup>th</sup> and 6<sup>th</sup> month of deployment. Multidimensional scaling (MDS) of wet biomass (Fig. 3a) showed a weak clustering reflecting time of deployment. The number of species showed a monotonic increase during all seasons and for all the filters (Fig. 2a). During the first two months of deployment, 19 to 29 species had colonized the filters (Plate II: Fig. 10).

Macrofaunal abundance also increased with time of deployment (Fig. 2b), showing very similar patterns for all three series of biofilters deployed during different months of the year. Shannon diversity was found to be quite stable after the first two months of deployment (Fig. 2c) and this was also the case with average taxonomic distinctness (Fig. 2d). Multidimensional scaling (MDS) of species abundance revealed biofilters clustering in relation to deployment period, regardless of deployment season (Fig. 3b).

The results of the present paper indicate that there is little change in fouling community attributes regarding the time of first deployment whereas the effect of duration of deployment is the major factor affecting the community structure.

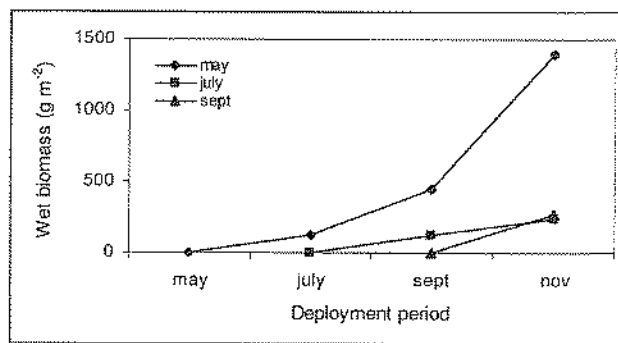

Fig. 1: Wet biomass of fouling organisms with deployment period.

Sl. 1: Biomasa organizmov obrasti v času postavitve biofiltrrov.

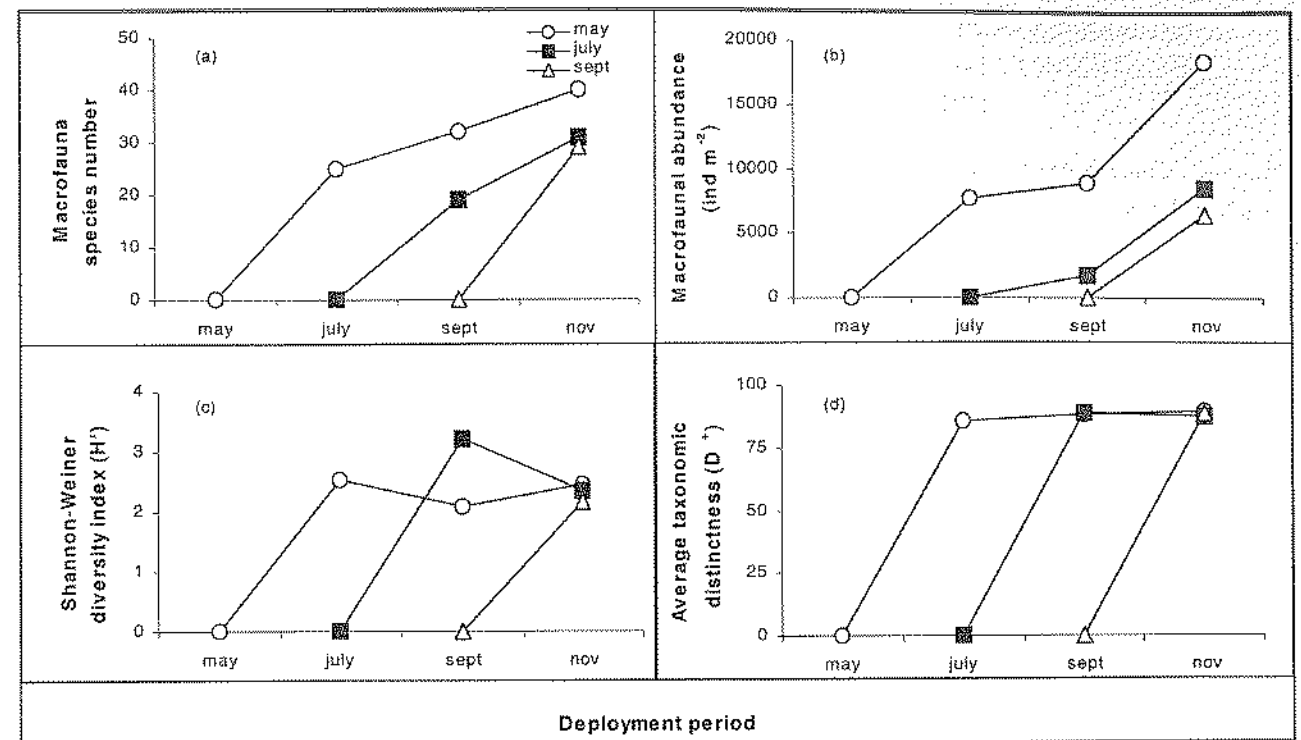

Fig. 2: (a) Species number; (b) macrofaunal abundance; (c) Shannon-Wiener diversity index; (d) average taxonomic distinctness with deployment period.

Sl. 2: (a) število vrst; (b) abundanca makrofavne; (c) Shannon-Wienerjev indeks diverzitet; (d) povprečna taksonomska različnost glede na obdobje postavitve.

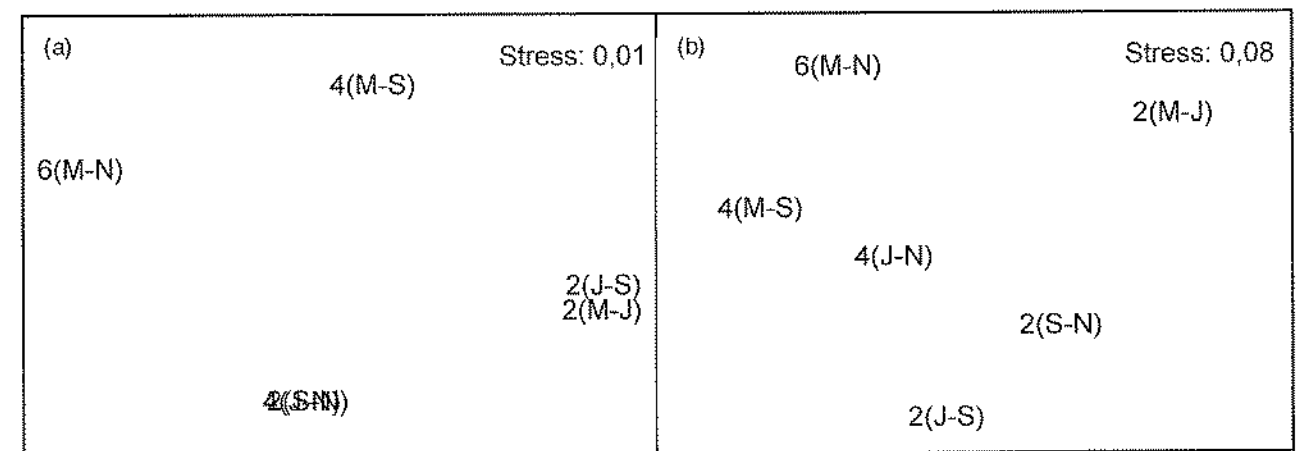

Fig. 3: (a) MDS of biofilters biomass; (b) MDS of species abundance at the biofilters.

Sl. 3: (a) MDS biomase biofiltrrov; (b) MDS abundance vrst na biofiltrih.

## UČINEK ČASA PRVE POSTAVITVE IN TRAJANJA NA SUKCESIJO BENTOŠKIH ORGANIZMOV NA BIOFITRIH, UPORABLJENIH ZA ZMANJŠEVANJE UČINKOV RIBOGOJNIC NA KAKOVOST VODE NA KRETI

Eugenia APOSTOLAKI, Manolis TSAPAKIS, Tatiana TSAGARAKI, Kostantia PAPADOPOULOU  
& Ioannis KARAKASSIS

Institute of Marine Biology of Crete, GR-71003 Heraklion, POB 2214

E-mail: jkarak@imbc.gr

### POVZETEK

V enem izmed zaprtih zalivov na Kreti so avtorji postavili 18 biofiltriv, da bi lahko preučevali njihovo učinkovitost ob uporabi lokalno razpoložljive združbe obrasti za zmanjšane učinke onesnaževanja, ki ga povzročajo lokalne ribogojnice. Biomasa, gostota in diverzitetna vrst med organizmi obrasti so se povečevale s podaljševanjem časa uporabe biofiltriv v vseh letnih časih in za vse razvrščene biofiltre. Po prvih dveh mesecih je bilo ugotovljeno, da sta Shannonov diverzitetni indeks in povprečna taksonomska različnost precej stabilna. Multidimenzionalna primerjava biomase in gostote vrst je razkrilo kopičenje na biofiltrih glede na čas njihove postavitve in ne glede na letni čas njihove postavitve.

**Ključne besede:** biofiltri, sukcesija, marikultura, vzhodni Mediteran, Kreta

### REFERENCES

Angel, D. & E. Spanier (2002): An application of artificial reefs to reduce organic enrichment caused by net-cage fish farming: preliminary results. ICES J. Mar. Sci., 59, 324-329.

Clarke, K. R. & R. M. Warwick (1994): Changes in Marine Communities: an approach to statistical analysis and interpretation. Plymouth Marine Laboratory, Plymouth, U.K.

Chopin, T., A. H. Buschmann, C. Halling, M. Troell, N. Kautsky, A. Neori, G. P. Kraemer, J. A. Zertuche-Gonzalez, C. Yarish & C. Neefus (2001): Integrating seaweeds into marine aquaculture systems: a key toward sustainability. J. Phycol., 37, 975-986.

Hall, P. O. J., O. Holby, S. Kollberg & M. O. Samuelsson (1992): Chemical fluxes and mass balances in a marine fish cage farm. IV. Nitrogen. Mar. Ecol. Prog. Ser., 89, 81-91.

Holby, O. & P. O. J. Hall (1991): Chemical fluxes and mass balances in a marine fish cage farm. II. Phosphorus. Mar. Ecol. Prog. Ser., 70, 263-272.

Kautsky, N. & C. Folke (1989): Management of coastal areas for a sustainable development of aquaculture. Biota, 5, 1-11.

Neori, A., M. Shpigel & D. Ben-Ezra (2000): A sustainable integrated system for culture of fish, seaweed and abalone. Aquaculture, 186, 279-291.

Pitta, P., I. Karakassis, M. Tsapakis & S. Zivanovic (1999): Natural vs. mariculture induced variability in nutrients and plankton in the Eastern Mediterranean. Hydrobiologia, 391, 181-194.

short scientific article  
received: 2003-09-05

UDK 639.32:504.064(267.33)

## MARICULTURE-ENVIRONMENT INTERACTIONS AND BIOFILTRATION IN OLIGOTROPHIC RED SEA WATERS

Dror L. ANGEL, Noa EDEN, Timor KATZ

Israel Oceanographic & Limnological Research, Ltd., National Center for Mariculture, Eilat, Israel

e-mail dror@mit.edu

&

Ehud SPANIER

The Leon Recanati Center for Maritime Studies, Haifa University, Haifa, Israel

### ABSTRACT

A series of porous plastic cylinders were suspended next to net-pen fish farms and at nearby reference sites in an experiment that was conducted in Scotland, Slovenia, Greece and Israel (Red Sea). The purpose of the experiment was to see if the biofouling communities that developed on the cylinders near the fish farms were significantly different from the reference site and whether we could measure significant uptake of fish farm effluents. The most significant differences between fish farm and reference were detected at the Israeli sites, and this was attributed to the strong signal to noise ratio in the oligotrophic waters of the Red Sea.

**Key words:** marine aquaculture, biofilters, biofouling, oligotrophic sea, Red Sea

## INTERAZIONI MARICOLTURA-AMBIENTE E BIOFILTRAZIONE IN ACQUE OLIGOTROFICHE DEL MAR ROSSO: VALORE DI UN FORTE SEGNALE NEGLI INDICI DI DISTURBO

### SINTESI

Serie di cilindri di plastica porosa sono state sospese in prossimità di allevamenti di pesci in recinti e in siti di controllo poco distanti, durante un esperimento condotto in Scozia, Slovenia, Grecia ed Israele (Mar Rosso). Scopo dell'esperimento era quello di constatare se le comunità di biofouling sviluppatesi su cilindri vicini agli allevamenti di pesci differiscono significativamente da quelle in siti di controllo e se è possibile misurare notevoli assorbimenti di effluenti provenienti dall'allevamento di pesci. La differenza più evidente tra i siti di controllo e gli allevamenti di pesci è stata registrata in acque di Israele, ed è stata attribuita ad un forte segnale negli indici di disturbo, in acque oligotrofiche del Mar Rosso.

**Parole chiave:** acquacoltura marina, biofiltri, segnale negli indici di disturbo, mare oligotrofico, Mar Rosso



## INTRODUCTION

Marine finfish aquaculture generally affects the underlying sediments as a result of the rain of particulate organic matter constantly falling to the seafloor, but it is generally more difficult to detect the dissolved effluents and their effects on the surrounding water column (Pearson & Black, 2001). The "elusive" nature of dissolved nutrients emitted from fish cages is due to the fact that fish excrete nutrients in a pulsed fashion (nutrients are excreted several hours after feed is ingested; Porter *et al.*, 1987) and these compounds are then subject to dilution, advection and biological uptake. Since it is much more difficult to accurately monitor nutrient release from fish cages in the sea, controlled tank experiments have been used to determine nutrient budgets for cultured fish and these indicate that intensively-reared carnivorous fish (as salmon and seabream) excrete considerable amounts of

dissolved nutrients (70% and 35% of ingested N and P, respectively; Pearson & Black, 2001; Lupatsch & Kissil, 1998).

There has been some debate regarding the actual effects of aquaculture effluent loading (both dissolved and particulate forms) on the marine environment and it appears that this may vary as a function of the trophic status of the surrounding waters. It is generally accepted, however, that the effluents released from fish cages should be minimized and we have examined the deployment of biofilters around fish cages (the BIOFAQs project) to accomplish this.

A factor that determines the success of such deployments is our ability to measure nutrient uptake by the experimental system in comparison to the reference. In other words, the proof (or failure) of the concept hinges on our ability to clearly separate a significant signal from the background noise.

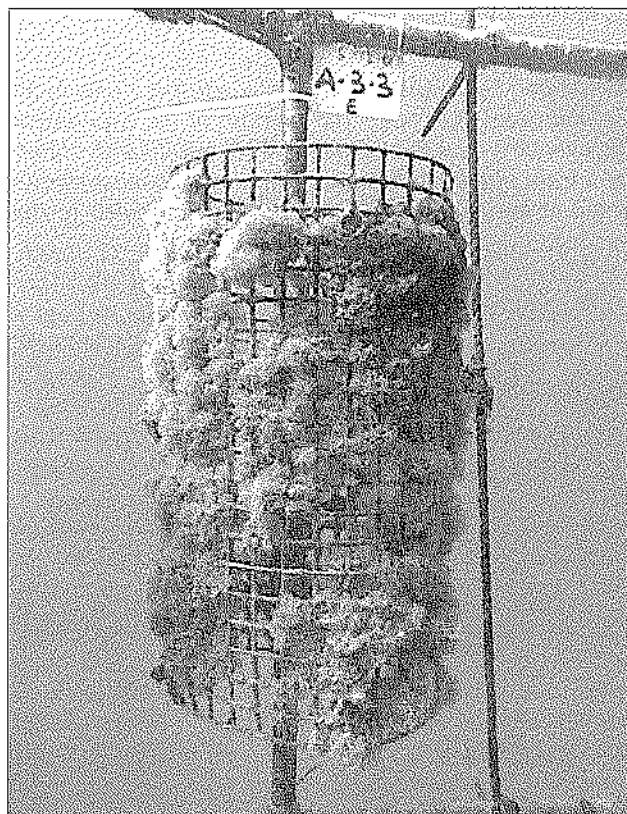

**Fig. 1:** Biofouling community associated with one of the biofilter units at the fish-farm site 6 months after deployment.

**Sl. 1:** Združba obrasti na biofiltru ob ribogojnici šest mesecev po njihovi postavitvi.



**Fig. 2:** Biofouling community is virtually absent from the biofilter units at the reference site 6 months after deployment.

**Sl. 2:** Domala neporasli biofilter na referenčni postaji šest mesecev po postavitvi.

The Gulf of Aqaba, Red Sea, is an oligotrophic body of water that supports two commercial Israeli net-cage fish farms. These farms serve as point-sources of nutrients that are released to the surrounding waters and sediments. In an attempt to capture and remove effluents from the fish farm region, experimental biofilters were deployed and tested and the results of these deployments were compared to similar tests conducted at fish farms in 3 other countries: Scotland, Slovenia and Greece.

## MATERIALS AND METHODS

The experimental design was identical (for comparative purposes) at 4 study sites in Scotland, Slovenia, Greece and Israel and consisted of deployment of arrays of cylindrical, plastic-mesh biofilters adjacent to the fish farm and at a reference site, 400 m away from the farm. The biofilters were monitored and subsampled on a bi-monthly basis to compare biofouling biomass and community composition.

## RESULTS AND DISCUSSION

The biofouling biomass associated with the cylindrical biofilters at the fish farm site (Fig. 1) was much larger than the biomass at the reference site (Fig. 2), indicating that the fish-farm biofilter communities were growing more rapidly. We have proposed that this is due to the larger food resources available at the fish farm. This preliminary conclusion relies mainly on the fact that the Gulf of Aqaba is oligotrophic (Reiss & Hottinger, 1984) and there are no other major nutrient sources in the re-

gion, aside from the fish farm effluents. At other BIOFAQs study sites, there was not as clear a distinction between the biomass accumulation at the fish farm site vs the reference site and it is assumed this is due, at least partially, to the distinctly different microenvironment that exists around the fish farm.

In an accompanying study, Lojen *et al.* (2003, *this volume*) examined stable isotope biomarkers to identify the source of material contributing to the biofilter biomass. The source was identified as particulate material released from the fish farm and taken up by the biofilter-associated biota. The interpretation of the data in this study was facilitated by the large signal to noise ratio due to the fact that the fish farm is a large, identifiable point source operating in an oligotrophic basin that has very few terrestrial or aeolic inputs. When compared to similar stable-isotope studies within the BIOFAQs project that were conducted in more productive waters with more "background noise" (large terrestrial inputs of organic and inorganic compounds, high algal and zooplankton biomass), it was much harder to determine if the biofilter communities near the fish cages were taking up fish farm effluents.

There are many advantages to carrying out marine research in the Gulf of Aqaba and the presence of finfish farms in these unique, oligotrophic waters constitutes a large-scale, *in-situ* nutrient-enrichment experiment; not extremely dissimilar to the IRONEX experiments currently going on in the Southern Ocean, with many opportunities to study aquaculture and nutrient impacts.

## OKOLJSKE INTERAKCIJE V MARIKULTURI IN BIOFILTRIRANJE V OLIGOTROFNIH VODAH RDEČEGA MORJA

Dror L. ANGEL, Noa EDEN, Timor KATZ

Israel Oceanographic & Limnological Research, Ltd., National Center for Mariculture, Eilat, Israel

e-mail dror@mit.edu

&

Ehud SPANIER

The Leon Recanati Center for Maritime Studies, Haifa University, Haifa, Israel

## POVZETEK

Avtorji so med eksperimentom, ki so ga opravili na Škotskem, v Sloveniji, Grčiji in Izraelu (v Rdečem morju), ob kletkah za gojenje rib in na bližnjih referenčnih lokacijah obesili vrsto luknjičavih plastičnih valjev. Namen eksperimenta je bil ugotoviti, ali se obrast, ki se je razvila na valjih v bližini marikulturnih kletk, močno razlikuje od referenčnih lokacij in ali je mogoče izmeriti pomenljivi privzem odpadnih voda. Najpomembnejše razlike v obrasti biofiltriranih ob ribogojnicah in na referenčnih postajah so bile ugotovljene na izraelskih lokacijah, kar so avtorji pripisali znatno manjšemu vplivu drugih virov onesnaženja v oligotrofnih vodah Rdečega morja.

**Ključne besede:** marikultura, biofiltri, obrast, oligotrofno morje, Rdeče morje

## REFERENCES

- Lojen, S., D. Angel, T. Katz, M. Tsapakis, N. Kovač & Alenka Malej (2003):  $^{15}\text{N}$  enrichment in fouling communities influenced by organic waste deriving from fish farms. *Annals Istr. Medit. Stud.* 13 (1) Suppl. 9-12.
- Lupatch, I. & G. W. Kissil, (1998): Predicting aquaculture waste from gilthead seabream (*Sparus aurata*) culture using a nutritional approach. *Aquat. Living Resour.* 11, 265-268.
- Pearson, T. H. & K. D. Black, (2001): The environmental impacts of marine fish cage culture. In: Black, K. D. (ed.) *Environmental Impacts of Aquaculture*. Sheffield Academic Press, pp. 1-30.
- Porter C. B., Krom M. D., Robbins M. G., Brickell L. & A. Davidson (1987): Ammonia excretion and total n budget for gilthead seabream (*Sparus aurata*) and its effect on water-quality conditions. *Aquaculture* 66: 287-297
- Reiss, Z. & L. Hottinger, (1984): *The Gulf Of Aqaba: Ecological Micropaleontology*. Springer-Verlag, New-York.

short scientific article  
received: 2003-09-19

UDK 639.32:504.064(262.3-18)

## THE INFLUENCE OF FISH CAGE AQUACULTURE ON BACTERIOPLANKTON IN THE BAY OF PIRAN (GULF OF TRIESTE, ADRIATIC SEA)

Valentina TURK &amp; Alenka MALEJ

National Institute of Biology, Marine Biology Station Piran, SI-6330 Piran, Fornače 41

E-mail: turk@mbss.org

## ABSTRACT

*The impact of fish cages on bacterioplankton was examined in enclosures containing seawater from cage and non-cage sites and natural plankton from the Bay of Piran (northern Adriatic). Nutrient enriched seawater stimulates bacterial production and abundance. This observation was further investigated in situ, where for 3 months submerged bio-filter with Schizobrachiella sanguinea dominating fouling community was enclosed in mesocosm. Based on the results of bacterial production and abundance, we assumed that filter feeding could remove significant amount of bacteria attached on suspended particles and thus depleting bacterioplankton in the water column.*

**Key words:** aquaculture, environmental impact, bacterioplankton, cyanobacteria, Adriatic Sea

## INFLUENZA DELLA PISCICOLTURA IN GABBIE SUL BATTERIOPLANKTON NELLA BAIA DI PIRANO (GOLFO DI TRIESTE, MARE ADRIATICO)

## SINTESI

*L'impatto di un allevamento di pesci in gabbie sul batterioplancton è stato esaminato in contenitori da laboratorio contenenti acqua marina proveniente dall'allevamento, da un sito prossimo all'allevamento e da una stazione di controllo con plancton naturale della baia di Pirano (Adriatico settentrionale). L'acqua proveniente dall'allevamento di pesci, arricchita in nutrienti, stimola la produzione e l'abbondanza batterica. Tale osservazione è stata successivamente investigata in situ con l'immersione per tre mesi di bio-filtri con una comunità di fouling con predominante Schizobrachiella sanguinea inclusa nel mesocosmo. In base ai risultati di produzione ed abbondanza batterica, gli autori concludono che l'alimentazione di filtri può rimuovere quantità significanti di batteri legati al particolato sospeso e quindi diminuire il batterioplancton nella colonna d'acqua.*

**Parole chiave:** acquacoltura, impatto ambientale, batterioplancton, cianobatteri, mare Adriatico

INTRODUCTION

Bacteria play a central role in all major nutrient cycles in the marine environment (Azam, 1998). They are also most important organisms involved in different systems designed to treat domestic wastewaters. During the last few years, a series of papers was published addressing the impact of fish farming on water column chemistry and the effect on plankton distribution (Pitta *et al.*, 1999; Alongi *et al.*, 2002). However, the role of bacteria in the environment impacted by the caged fish culture has received little attention. Bacterioplankton community and abundance in pelagic system can be regulated by bottom-up and top down regulating forces. The fish farming activity may have direct and indirect effects on the components of the microbial food web either by changing nutrient status of the environment or by altering prey and predator community composition.

The present study is part of the EU funded project BIOFAQs (Bio-filtration and Aquaculture: an Evaluation of Hard Substrate Deployment Performance Within Mariculture Developments) (Angel, 2001; Black *et al.*, 2001). The main objective was to assess the effectiveness of deployment of artificial substrates (bio-filters) in the water column in reducing the environmental impacts of cage fish culture. By providing surface area for sessile biota and microbial colonization, bio-filters would facilitate uptake of organic and inorganic matter released by farmed fish. Within this project the microbial dynamics was followed in the enrichment experiment, using seawater from fish cage as nutrient source for enclosed plankton population, and seawater collected at unimpacted area. Additionally, microbial abundance and production was measured in mesocosm with enclosed bio-filters together with surrounding water during 2 diel cycles.

MATERIAL AND METHODS

Enrichment experiment was undertaken in July 2001 and lasted for 5 days (from 30<sup>th</sup> July to 5<sup>th</sup> August). Seawater was collected with Niskin sampler in the middle of the fish cage (treatment C), at the station about 200 m from the cages (station CL, 5 m depth) (treatment B), and at the stations in the middle of the Bay of Piran (45°30.20; 13°34.20) (control – treatment A) (Plate I: Fig. 1). Seawater was filtered through 0.22 µm pore size filters (Millipore), poured into the transparent polyethylene bottles (Nalgen, 8 litres), and one litre of concentrated seawater with entire plankton community was added. Experimental plankton communities were collected above the thermocline layer (14 m depth) in the middle of the Bay of Piran. Enclosures were incubated *in situ* at a depth of 2 m, to provide natural temperature and light conditions.

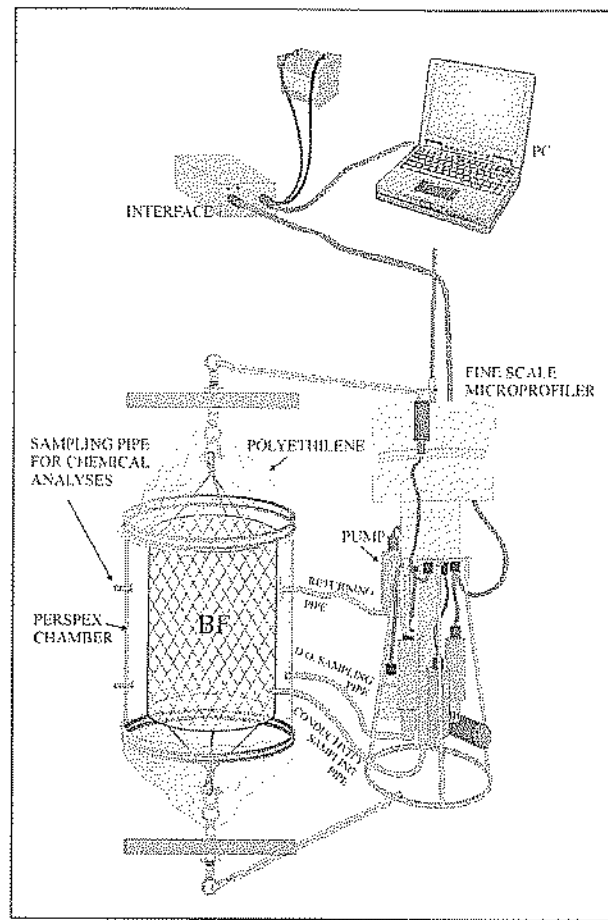

Fig. 1: Scheme of the mesocosm in situ enclosure experiment.

Sl. 1: Shema mezokozemskega eksperimenta v naravnem okolju.

*In situ* enclosure (mesocosm) (Fig. 1) experiments were performed on the 3<sup>rd</sup> and 5<sup>th</sup> months after bio-filters immersion into natural environment (Plate I: Fig. 1) at the station near fish cages (station SL), and at the station 200 m from the cages (station CL) (Plate II: Fig. 14). The mesocosm represented an *in situ* enclosure of selected bio-filter in natural environment. Each selected bio-filter was enclosed within a clear acrylic plastic octagon box, with a volume of about 110 litres (Fig. 1). A fine scale profiler with sensors (Sea Bird and Sea Tech) was connected to the chamber to measure, each hour, temperature, conductivity, dissolved oxygen and fluorescence. Divers collected samples for chemical and biological parameters from the chamber five times over 24 hours, from 26 to 27 September and 21 to 22 November at the station CL and at the station SL from 27 to 28 September 2001 and from 23 to 24 November 2001. At the same time intervals water column characteristics were performed using fine-scale profiler (CTD - University of Australia). The seawater for chemical and bio-

logical parameters was collected at three different depths (5 m, 8 m, 11 m) using a membrane pump (flow rate 20 l per minute).

Heterotrophic bacteria were counted according to the Porter and Feig protocol (Porter & Feig, 1980) and the biovolume of bacteria was converted into carbon biomass using 20 fg C cell<sup>-1</sup> as the conversion factor (Lee & Fuhrman, 1987). Cyanobacteria were counted in green excitation using an epifluorescence microscope (Takahashi *et al.*, 1985). Bacterial production (BP) was measured by <sup>3</sup>H-leucine incorporations according to procedures of Smith & Azam (1992). Each time, 1.7 ml of seawater was incubated with L-[4,5-<sup>3</sup>H] leucine (20 nM final, Amersham) for 1 hour at *in situ* temperature. All samples were done in triplicate. Bacterial production was calculated as in Simon & Azam (1989). At the same time, <sup>3</sup>H-thymidine incorporation method was used in parallel samples (Fuhrman & Azam, 1982). Triplicates of each sample were incubated for one hour at *in situ* temperature with 250µCi <sup>3</sup>H-thymidine l<sup>-1</sup> (sp. act. 80 Ci mmol<sup>-1</sup>, Amersham). Moles of thymidine incorporated were converted to cells produced by the conversion factor 2 x 10<sup>18</sup> cells mole<sup>-1</sup>.

RESULTS AND DISCUSSION

An enrichment experiment was set up to examine the impact of fish farming on nutrients and microplankton distribution. During the five days of incubation, natural bacterioplankton community showed significant enhancement on production rates and biomass accumulation in the enclosures with the water from the fish cage (treatment C) and nearby station (treatment B), compared to the seawater from the non-impacted area (treatment A). Abundance of bacteria increased from 0.5 to 4.3 x 10<sup>8</sup> cells l<sup>-1</sup> in the treatment B, from 0.6 to 3.8 x 10<sup>8</sup> cells l<sup>-1</sup> in the treatment C three days after the inoculation (Fig. 2). The highest bacterial production was measured on the second day with the value of 2.02 µg C l<sup>-1</sup> h<sup>-1</sup> in the treatment B, compared to the production of 1.01 µg C l<sup>-1</sup> h<sup>-1</sup> in the treatment C (Fig. 2). Cyanobacteria were more abundant in the treatment with seawater from fish farm (treatment C) and increased from 3.3 to 7.8 x 10<sup>7</sup> cells l<sup>-1</sup> in treatment B, and from 3.1 up to 11.0 x 10<sup>7</sup> cells l<sup>-1</sup> in treatment C within four days of incubation, and only up to 2.8 x 10<sup>7</sup> cells l<sup>-1</sup> in the control bottle. Natural population of heterotrophic bacteria quickly responded to the nutrient enriched seawater, preceding autotrophic organisms, which was also reported in previous studies (Pitta *et al.*, 1996; Malej *et al.*, 2003).

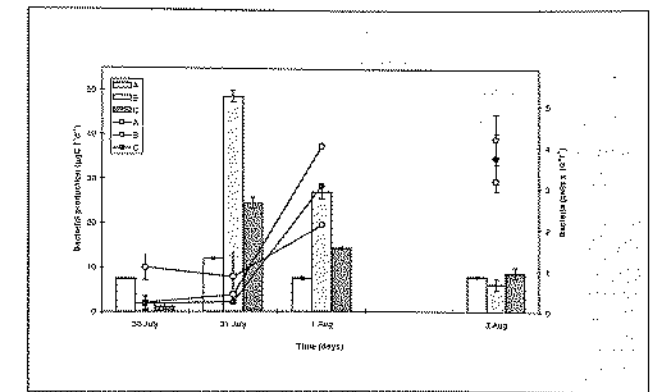

Fig. 2: The bacterial abundance (—) and production (□) in different nutrient treatments during the enrichment experiment lasting from 30<sup>th</sup> July to 5<sup>th</sup> August 2001.

Sl. 2: Gostota bakterij (—) in produkcija (□) v različnih hranilnih razmerah v obogatitvenem poizkusu v času od 30. julija do 5. avgusta 2001.

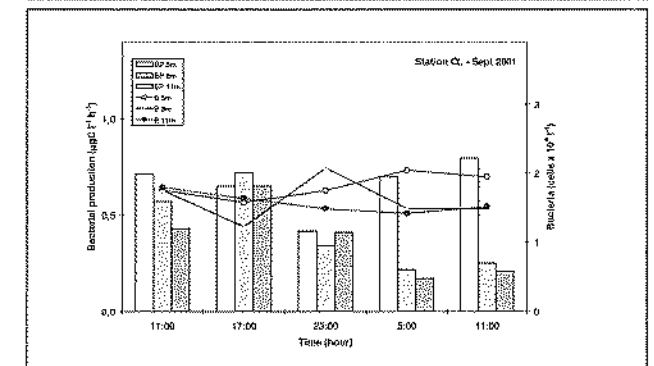
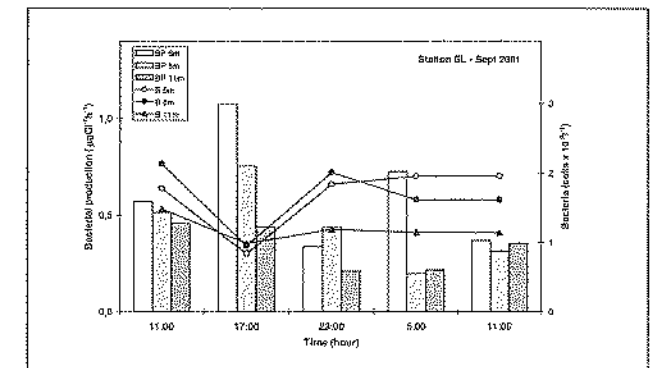

Fig. 3: Bacterial abundance and bacterial production in the water column during 24-hour cycle at the station near the fish cages (station SL) and the station 200m away from the cages (station CL) in September 2001.

Sl. 3: Gostota bakterij in bakterijska produkcija v vodnem stolpcu (5 m, 8 m, 11 m) na postaji blizu ribjih kletk (postaja SL) in na postaji, oddaljeni 200m od ribjih kletk (postaja CL) 24-mesečnem ciklu v septembru 2001.



**Tab. 1: Average bacterial abundance, bacterial production (BP) and P/B ratio in the water column at the station near the fish cages (station SL) and the station located 200 m away (station CL) during 24-hour measurement from 26 to 28 September and from 27 to 29 November 2001.**

**Tab. 1: Povprečne gostote bakterij, bakterijske produkcije (BP) in P/B razmerja v vodnem stolpcu na postaji blizu ribjih kletk (postaja SL) in na postaji, oddaljeni 200 m (postaja CL) v 24-urnih meritvah od 26. do 28. septembra in od 27. do 29. novembra 2001.**

Station	CL			SL			SL/CL %
	No.	Average	± SD	No.	Average	± SD	
<b>26/28 September 2001</b>							
Abundance (cells l <sup>-1</sup> )	11	1.57 x 10 <sup>9</sup>	3.75 x 10 <sup>8</sup>	11	1.49 x 10 <sup>9</sup>	4.57 x 10 <sup>8</sup>	95
BP ( <sup>3</sup> H-Thy) (µgC l <sup>-1</sup> d <sup>-1</sup> )	15	3.78	1.63	15	3.97	1.86	105
BP ( <sup>3</sup> H-Leu) (µgC l <sup>-1</sup> d <sup>-1</sup> )	15	4.80	2.27	15	5.84	3.09	122
P/B (d <sup>-1</sup> )	11	0.178		11	0.247		
<b>27/29 November 2001</b>							
Abundance (cells l <sup>-1</sup> )	8	1.15 x 10 <sup>9</sup>	1.29 x 10 <sup>8</sup>	8	1.10 x 10 <sup>9</sup>	7.64 x 10 <sup>7</sup>	96
BP ( <sup>3</sup> H-Leu) (µgC l <sup>-1</sup> d <sup>-1</sup> )	15	3.55	0.66	15	3.92	1.43	110
P/B (d <sup>-1</sup> )	8	0.154		8	0.175		

Based on laboratory results, we decided to examine the possible effect of fish farm on bacterioplankton dynamic in the field. During the study of diurnal dynamics, five samples at three different depths (5 m, 8 m and 11 m) were analysed for each station (Fig. 3). Vertical distribution of heterotrophic bacteria was similar at all sampled depths, and the abundance varied from 1.41 x 10<sup>9</sup> cells l<sup>-1</sup> to 2.3 x 10<sup>9</sup> cells l<sup>-1</sup>. The bacterial production measured as <sup>3</sup>H-leucine incorporation varied from 0.2 to 1.9 µg C l<sup>-1</sup> h<sup>-1</sup> at the station CL and from 0.2 to 1.1 µg C l<sup>-1</sup> h<sup>-1</sup> at the station SL, with the highest values at 5m depth over the 24 hour experiment (Fig. 3). Comparison between both sampling locations is presented in Table 1, based on the results of bacterial abundance and production rates during the 24-hour measurements in September and November. The average number of bacteria was 1.49 x 10<sup>9</sup> cells l<sup>-1</sup> (±3.8x 10<sup>8</sup>, n=11) at the station near the fish cages, compared to the average number of 1.57 x 10<sup>9</sup> cells l<sup>-1</sup> (±4.6x 10<sup>8</sup>, n=11) at the station located 200 m away. Bacterial production measured as <sup>3</sup>H-leucine incorporation was 5.84 µg C l<sup>-1</sup> d<sup>-1</sup> (±3.1 µg C l<sup>-1</sup> d<sup>-1</sup>, n=15) and 4.8 µg C l<sup>-1</sup> d<sup>-1</sup> (±2.3 µg C l<sup>-1</sup> d<sup>-1</sup>, n=15) at the station SL and CL, respectively. Similar were results of the bacterial production measured as <sup>3</sup>H-thymidine incorporation (Tab. 1). No difference between both stations was recorded in November. The average number of bacteria was 1.15 x 10<sup>9</sup> cells l<sup>-1</sup> at the station CL and 1.10 x 10<sup>9</sup> cells l<sup>-1</sup> at the station SL. The bacterial production was 3.92 µg C l<sup>-1</sup> d<sup>-1</sup> at the station SL and 3.55 µg C l<sup>-1</sup> d<sup>-1</sup> at the station CL (Tab. 1). The P/B ratios for the heterotrophic bacteria were from 0.070 to 0.342 for the station CL and from 0.071 to 0.642 at the station SL. Although the average biomass of bacteria was higher at the station located 200 m away from the fish farm, bacterial production was higher (5-22%) at the station near the fish cages. However, the abundance and pro-

duction rates were in the range reported for the Gulf of Trieste (Turk *et al.*, 2001). Similar results were reported from other areas in the Mediterranean (Pitta *et al.*, 1999), when the plankton community structures and abundance were more dependent on seasonal environmental characteristics and locations than by the presence of fish farming.

In contrast to the results in the water column that did not show a significant difference, the results obtained in the enclosures were different, thus eliminating currents and tides. *In situ* mesocosm experiments were performed in order to relate microbial dynamics to sessile biota on bio-filter. The experiment was performed in

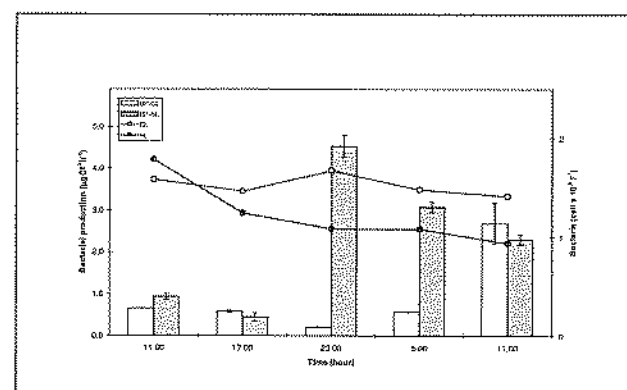

**Fig. 4: Results of bacterial abundance and bacterial production in the mesocosm experiment at the station near the fish cages (station SL) and at the station location above 200 m away (station CL) during 24-hour cycle in September 2001.**

**Sl. 4: Gostota bakterij in bakterijska produkcija v mezokozemskem poizkusu na postaji blizu ribjih kletk (postaja SL) in na postaji, oddaljeni 200 m (postaja CL) v 24-urnem ciklu, septembra 2001.**

September using the bio-filter, submerged for 3 months near the fish cages at a depth of 5 m. Dominating fouling community on the enclosed bio-filter was bryozoan (*Schizobrachiella sanguinea*) (Frumen *et al.*, this volume). Over a diel cycle, bacterial numbers constantly decreased throughout the experiment from 2.2 x 10<sup>9</sup> cells l<sup>-1</sup> to 1.1 x 10<sup>9</sup> cells l<sup>-1</sup> at the station SL (Fig. 4). Contrary to bacterial abundance, production showed an increase from midnight and early morning up to 4.5 µg C l<sup>-1</sup> h<sup>-1</sup> in the enclosure with bio-filter at the station near the fish farm (station SL). According to high bacterial production and constant decrease in number during the night, it is assumed that the majority of the bacteria produced were consumed, presumably due to grazing of sessile organisms on bio-filters. Studies on bryozoans

feeding indicate that small particles are principal food source (Hudges, 2001).

Our preliminary study did not reveal any large-scale eutrophication or significant differences between stations near the fish farm cages and open water stations. However, a pronounced response of bacterial community was observed after addition of enriched water from the fish farm in laboratory experiment and for *in situ* mesocosm experiment. Results from mesocosm experiment showed that filter feeding could remove significant amount of attached bacteria on suspended particles and thus deplete bacterioplankton in the water column. However, bacteria within the pelagic ecosystem recycle the excreted nutrients and additional investigations should be considered in the future.

## VPLIV MARIKULTURE NA BAKTERIOPLANKTON V PIRANSKEM ZALIVU

Valentina TURK & Alenka MALEJ

Nacionalni inštitut za biologijo, Morska biološka postaja, SI-6330 Piran, Fornače 41

E-mail: turk@mbss.org

### POVZETEK

*Avtorici sta preučevali vpliv gojenja rib v kletkah na bakterio plankton v morski vodi z naravnim planktonom, vzeti z lokacij s kletkami in 200 m od njih v Piranskem zalivu. S hranilnimi snovmi obogatena morska voda spodbuja produkcijo in gostoto bakterij. Raziskave sta opravili tudi v naravnem okolju, v katerem je bil za 3 mesece potopljeni biofilter s prevladujočo vrsto Schizobrachiella sanguinea obdan z mezokozmom. Glede na rezultate produkcije in gostote bakterij avtorici domnevata, da bi filtratorski organizmi s hranjenjem lahko odstranili precejšnjo količino bakterij na suspendiranih delcih in tako zmanjšajo vlogo bakterio planktona v vodnem stolpcu.*

**Ključne besede:** marikultura, okoljski vplivi, bakterio plankton, cianobakterije, Jadransko morje

### REFERENCES

- Alongi, D. M., V. C. Chong, P. Dixon, A. Sasekumar & F. Tirendi (2002): The influence of fish cage aquaculture on pelagic carbon flow and water chemistry in tidally dominated mangrove estuaries of peninsular Malaysia. *Mar. Environ. Res.*, 55, 313-333.
- Angel, D. (2001): A review of biofiltration processes as used in waste management. In: A review of the environmental impacts of marine cage aquaculture, processes of biofiltration relevant to impact mitigation, the biological properties of marine invertebrates relevant to biofiltration and biofouling on artificial structures. *BIO-FAQs Ann. Rep., Techn. Annex*, p. 31-45.
- Arzul, G., C. A. Clement & A. Pinier (1996): Effects on phytoplankton growth of dissolved substances produced by fish farming. *Aquat. Living Resour.*, 9, 95-102.
- Azam, F. (1998): Microbial control of oceanic carbon flux: The plot thickens. *Science*, 280, 694-696.
- Black, K. D., M. D. J. Sayer, E. Cook, D. Angel, E. Spanier, I. Karakasis, A. Malej, K. Collins, H. Pickering, S. Whitmarsh & S. Lojen (2001): BIOFAQs – BIOfiltration and Aquaculture: an evaluation of substrate deployment performance with mariculture developments. *Cahier Options Mediterranennes*, 55, 205-207.
- Frumen, A., B. Vrišer & A. Malej (2003): Suspended biofilters: succession of fouling communities immediately adjacent to fish cage and control location. *Annales, Ser. hist. nat.*, 11(1), Suppl.
- Fuhrman, J. & F. Azam (1982): Thymidine incorporation as a measure of heterotrophic bacterioplankton production in marine surface waters: evaluation and field results. *Mar. Biol.*, 66, 109-120.

**Hughes, D. (2001):** A review of biological filtration by marine invertebrates. In: A review of the environmental impacts of marine cage aquaculture, processes of biofiltration relevant to impact mitigation, the biological properties of marine invertebrates relevant to biofiltration and biofouling on artificial structures. BIOFAQs Ann. Rep., Techn. Annex, p. 49-77.

**Lee, S. & J. A. Fuhrman (1987):** Relationships between biovolume and biomass of naturally derived marine bacterioplankton. Appl. Environ. Microbiol., 53, 1298-1303.

**Malej, A., P. Mozetič, V. Turk, S. Terzić, M. Ahel & G. Cauwet (2003):** Changes in particulate and dissolved organic matter in nutrient-enriched enclosures from an area influenced by mucilage: the northern Adriatic Sea. J. Plankton Res., 25, 949-966.

**Pitta, P., I. Karakassis, M. Tsapakis & S. Zivanović (1999):** Natural vs. mariculture induced variability in nutrients and plankton in the eastern Mediterranean. Hydrobiologia, 391, 181-194.

**Porter, K. G. & Y. S. Feig (1980):** The use of DAPI for identifying and counting aquatic microflora. Limnol. Oceanogr., 25, 943-948.

**Simon, M. & F. Azam (1989):** Protein content and protein synthesis rates of planktonic marine bacteria. Mar. Ecol. Prog. Ser., 51, 201-213.

**Smith, D. C. & F. Azam (1992):** A simple, economical method for measuring bacterial protein synthesis rates in seawater using 3H-leucine. Mar. Microb. Food Webs, 6, 107-114.

**Takahashi, M., K. Kikuchi & Y. Hara (1985):** Importance of picocyanobacteria biomass (unicellular, blue-green algae) in the phytoplankton population of the coastal waters of Japan. Mar. Biol., 89, 63-69.

**Turk, V., P. Mozetič & A. Malej (2001):** Seasonal variability in phytoplankton and bacterioplankton distribution in the semi-enclosed temperate gulf (Gulf of Trieste, Adriatic Sea). Annales, Ser. hist. nat., 11(1), 53-64.

short scientific article  
received: 5. 09. 2003

UDK 504.064:574.6(26)

## BIOFILTER COMMUNITY OXYGEN CONSUMPTION RATES

Ken COLLINS & Jenny MALLINSON

School of Ocean and Earth Science, University of Southampton, Southampton Oceanography Centre, Southampton SO14 3ZH, UK  
e-mail: kjc@soc.soton.ac.uk

### ABSTRACT

*Biofilter communities have been incubated in-situ in UK, Israel and Slovenia. Oxygen fluxes for light and dark experiments have been normalised using the ash free dry weight of the biota. Respiration rates for different communities, whether dominated by ascidians, hydroids, worms or sponges, show a remarkably consistent trend with temperature, over the range 6-27°C. It is planned to link respiration to rates of growth, filtering and nutrient release.*

**Key words:** community respiration, *in-situ* incubation, ascidians, hydroids, tube worms

## TASSI DI CONSUMO DI OSSIGENO IN COMUNITÀ DI BIOFILTRI

### SINTESI

*Gli autori hanno studiato la crescita sovrabbondante di comunità di biofiltri in-situ in Regno Unito, Israele e Slovenia. I risultati dei flussi di ossigeno in esperimenti di luce e buio sono stati normalizzati in base al peso secco privo di cenere del biota. A prescindere dalla composizione delle comunità, dominate a turno da ascidiacei, idrozoi, policheti sedentari o spugne, i tassi respiratori hanno evidenziato una tendenza notevolmente uniforme con temperature nell'intervallo tra i 6 ed i 27°C. Gli autori intendono correlare i risultati delle misurazioni della respirazione con i tassi di crescita e filtrazione degli organismi ed il rilascio di nutrienti.*

**Parole chiave:** respirazione di comunità, incubazione *in-situ*, ascidiacei, idrozoi, policheti sedentari

INTRODUCTION

Ecological modelling of systems requires knowledge of the rates of energy flow. Thus, as well as the biomass in a system, its rate of growth or turnover should be determined. The growth rate of reef epibiota rate could be determined by measuring change in biomass per unit area, with time. This is likely to underestimate the true growth rate since this cannot account for loss by predation or other means. For a number of benthic infauna species the annual production per unit biomass has been calculated (Schwinghamer *et al.*, 1986). This approach has been widely adopted for determining the productivity and energy flows through benthic systems. However for many of the groups, which grow on hard substrates including artificial reefs (bryozoans, hydroids, sponges and ascidians) there is little or no information on their production to biomass ratios. Enclosed chamber (respirometer) experiments have a long history in examining the respiratory exchange and thus the energy utilization of animals (Collins *et al.*, 2002). The BIO-FAQs programme (Black *et al.*, 2001; plus other papers in this volume) has deployed experimental biofilters next to fish farms in order to determine the potential for the colonizing biota to remove wastes (particulate organic carbon and nutrients) from the water column downstream of the aquaculture facilities. This paper describes the results of *in-situ* incubation chamber experiments to determine direct measurement of oxygen fluxes (and thus carbon fluxes) of biofilter epibiota.

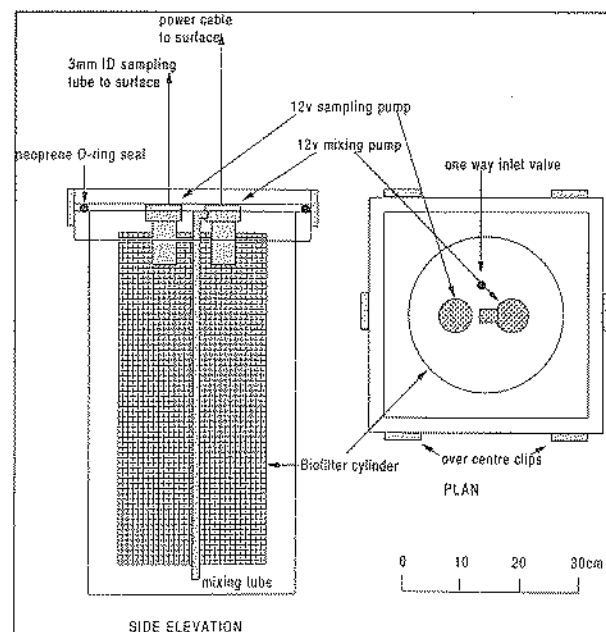

Fig. 1: Diagram of the biofilter incubation chamber. Fig. 1: Shema biofiltrske inkubacijske posode.

MATERIALS & METHODS

The biofilter incubation apparatus (Fig. 1) consisted of a specially constructed clear acrylic box (35 x 35 cm cross section, 65 cm high) which accommodated a whole biofilter, (a plastic mesh cylinder 50 cm long x 25 cm diameter) transferred underwater by divers. The top lid with neoprene seal was clamped shut with over-centre clips. An internal water pump (Rule, USA, bilge pump, 12 V, 380 min<sup>-1</sup>) was used to continuously mix the water in the chamber. A similar second pump was used to sample the chamber (30-40 min intervals) pumping water to the surface through 3 mm ID polythene tubing. The chamber water samples (160 ml, 3 replicates) were fixed for subsequent Winkler titration, to accurately measure the oxygen concentration. An oxygen electrode (YSI, model 5239) was used to monitor the progress of the incubation. Further Winkler titration bottles filled with water pumped from the chamber at the beginning of the experiment, were incubated *in-situ* under dark and light, to provide blanks, giving the magnitude of water column respiration and net photosynthesis respectively. Typically the chamber was incubated in the light for 2 hours then a further 2 hours in the dark, enclosed in a heavy-duty black polythene bag. This was considered to be a sufficiently short enough time to discount bacterial activity on the surface as of the chamber and not to cause starvation of the suspension feeders. Records of light intensity and temperature during the experiment and longer term enable extrapolation of the results of experiments over the whole year.

At the end of the incubation the biofilter was recovered and the epibiota removed, sorted into taxonomic groups and dried in aluminum foil trays to constant weight at 80°C. The dry samples were heated in a muffle furnace to 550°C for 4 hours to determine the organic content, ash free dry weight (AFDW). AFDW was used in this study as it was considered to be a good measure of the amount of living substance (Crisp, 1984). This is especially true given the number of calcareous organisms: hydroids, bryozoans and serpulid worm tubes that were present on the biofilters.

Oxygen analysis was done by a modification of the manual Winkler titration (Strickland & Parsons, 1968). Fixed samples were acidified with concentrated sulphuric acid and titrated with sodium thiosulphate solution in the sample bottle with an automated burette and photo-detector system to monitor the end point (Williams and Jenkinson, 1982). This system gave a repeatability of measurement in the order of ±0.2%.

RESULTS AND DISCUSSION

Bio-filter cylinders were deployed in July 2000, 2001 and 2002, 3 m below a pontoon in the Southampton Oceanography Centre dock and incubated at different

Tab. 1: Oxygen consumption rates for certain benthic invertebrates ( $\Phi\text{molO}_2 \text{ gAFDW}^{-1} \text{ hr}^{-1}$ ). Tab. 1: Poraba kisika ( $\Phi\text{molO}_2 \text{ gAFDW}^{-1} \text{ hr}^{-1}$ ) pri nekaterih bentoških nevretencarjih.

Taxon	Taxon. Group	Oxygen consumption ( $\Phi\text{molO}_2 \text{ gAFDW}^{-1} \text{ hr}^{-1}$ )	source
<i>Pyura stolonifera</i>	Asciacea	33	(Klumpp, 1984)
<i>Styella plicata</i>	Asciacea	66	(Klumpp, 1984)
<i>Ciona intestinalis</i>	Asciacea	47	(Klumpp, 1984)
<i>Aglaophenia</i> sp.	Hydroidea	75	(Gili & Hughes, 1995)
<i>Eudendrium racemosum</i>	Hydroidea	72	(Gili & Hughes, 1995)

times of the year to determine the response to temperature. These were originally intended simply to provide material for testing oxygen incubation chambers and refining the techniques. Prolific growth of the ascidian, *Asciella aspersa*, dominated the fouling community, reaching massive densities (27 kg wet weight per biofilter after 9 months) (Plate II, Fig. 11). A similar pattern of ascidian dominance and mass was found on the Scottish biofilters deployed at 12 m off Oban, Scotland. *In-situ* incubation experiments were conducted here in September 2002. The comparability of the two sites may be explained by the fact that they are both in temperate waters and receive high levels of organic particulates, from the adjacent fish farm in Scotland and from effluent discharges into the estuary in Southampton. The fast growth of ascidians which have high filtration rates suggests potential for significant removal of particulate effluents in temperate seas. In May 2003 *in-situ* incubation experiments at 5 m were carried out off Piran, Slovenia (Plate II, Fig. 14). These biofilters were dominated by calcareous tube worms (*Pomatoceros* sp.). Since all three sites were fauna dominated, only the respiration rates are reported. The rate of change in incubation chamber oxygen concentration with time was determined by linear regression (typically with an  $r^2 > 0.95$ ). After allowing for the water column blank, the values were related to the AFDW of the biofilter. Figure 2 shows this biofilter oxygen consumption data compared to that obtained from the Poole Bay, UK artificial reef. (Collins *et al.*, 2002). In the latter case whole colonized concrete reef blocks (20 x 20 x 40 cm) were incubated *in-situ* at 12 m. These were dominated by hydroids (*Halecium* spp.), bryozoans (*Bugula plumosa*) and calcareous tube worms (*Pomatoceros* sp.). One of the Southampton biofilters (20°C) was dominated by the fan worm *Sabella pavonina*.

Schwinghamer *et al.* (1986) demonstrate that production/biomass and other biological processes including respiration depend on size class. The biofilters and artificial reefs communities are dominated by macro fauna of sizes within 1-2 orders of magnitude, which may explain both the correspondence and variation in the data.

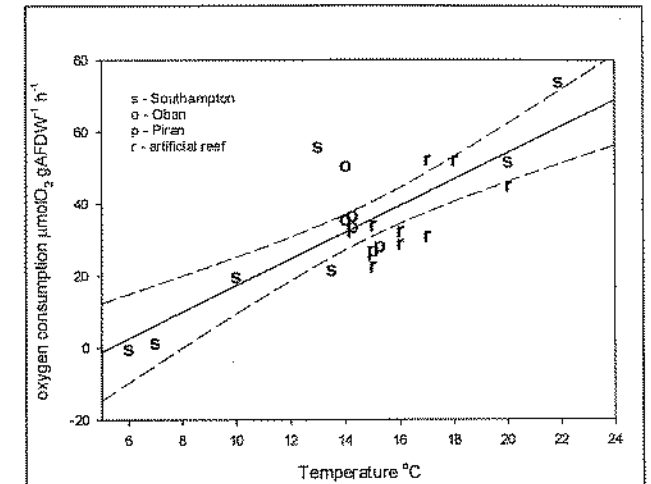

Fig. 2: Oxygen consumption by different communities plotted against incubation temperature: experimental biofilters from Southampton, Oban and Piran and concrete artificial reef blocks from Poole Bay (Collins *et al.*, 2002), showing a linear regression line with 95% confidence intervals.

Fig. 2: Poraba kisika pri različnih združbah v korelaciji z inkubacijsko temperaturo: poskusni biofiltri iz Southampton, Obana in Pirana in betonski umetni podvodni grebeni iz Poole Bay (Collins *et al.*, 2002) so premočrtno povezani (linearna regresija z 95% intervalom zaupanja).

Knowledge of instantaneous respiration rate of the biofilter community provides direct information on carbon and indirectly nitrogen and phosphorous fluxes. Current work is determining the nutrient release associated with biofilter community respiration. This will be combined with data from the other groups within the BIOFAQs project. Part of the energy derived from is devoted to growth (production). Published production/biomass ratios (Klumpp, 1984; Schwinghamer *et al.*, 1986; Petersen *et al.*, 1995) vary greatly, for the biofilter organisms values are in the range 10-40%. Comparison with known biofilter mass accumulation rates will help set limits to this. The filtration rates of biofilter organisms have been reviewed within the BIOFAQs



programme. For some organisms there is published information on the relationship of filtering rate to oxygen consumption: the ascidians *Pyura stolonifera* (Klumpp, 1984) and *Ciona intestinalis* (Petersen *et al.*, 1995). As with production it is hoped to partition part of the energy to filtration to derive a simple model of the functioning of biofilters for aquaculture or in a wider context the ability of hard substrate (natural or artificial) communities in coastal waters to remove particulate matter from the water column.

#### ACKNOWLEDGEMENTS

This work was supported by the EU funded BIOFAQs project. Incubation experiments were carried out at Southampton with the assistance of James Wyles, Elizabeth Vancura and Claire Lloyd. Considerable practical help with field work was given by many colleagues in Dunstaffnage Marine Laboratory, Oban and Marine Biological Station, Piran.

#### PORABA KISIKA NA BIOFILTRIHI

Ken COLLINS & Jenny MALLINSON

School of Ocean and Earth Science, University of Southampton, Southampton Oceanography Centre, Southampton SO14 3ZH, UK  
e-mail: kjc@soc.soton.ac.uk

#### POVZETEK

V Veliki Britaniji, Izraelu in Sloveniji sta avtorja spremljala proces obraščanja biofiltrskih združb *in situ*. Rezultati meritev kisika v svetlih in temnih razmerah so bili normalizirani na enoto organskega deleža biomase obrasti. Ne glede na sestavo združb in prevlado različnih skupin nevretenčarjev (kozolnjaki, trdoživnjaki, mnogoščetinci ali spužve) so rezultati respirometrije pokazali izredno enakomeren trend povezave s temperaturo v razponu med 6 in 27°C. Avtorja nameravata povezati rezultate respiracijskih meritev s stopnjo rasti filtratorjev in sproščanja hranil.

**Ključne besede:** respiracija združbe, inkubacija *in situ*, kozolnjaki, trdoživnjaki, cevkasti mnogoščetinci

#### REFERENCES

- Black, K. D., Sayer, M. D. J., Cook, E., Angel, D., Spanier, E. Karakassis, I., Malej, A., Collins, K., Pickering, H., Whitmarsh, D. and Lojen, S. (2001): BIOFAQs - BIOfiltration and Aquaculture: an evaluation of substrate deployment performance with mariculture developments. *Cahiers Options Méditerranéennes*, 55: 205-207.
- Collins, K.J., Jensen, A.C. and Smith, I. P. (2002): Oxygen fluxes of enclosed reef epibiota communities. *ICES Journal of Marine Science* 59: S94-S99.
- Crisp, D. J. (1984): Energy flow measurements. In: Holme, N. A. and McIntyre, A. D. (eds.) *Methods for the Study of the Marine Benthos*. IBP Handbook No.16, 2<sup>nd</sup> ed. Blackwell Scientific Publications, Oxford, pp. 284-373.
- Gili, J-M and Hughes, R. G. (1995): The ecology of marine benthic hydroids. *Oceanography and Marine Biology: an Annual Review* 33: 351-426.
- Grodzinski, W., Klekowski, R. Z. and Duncan, A. (1975): *Methods for Ecological Bioenergetics*. IBP Handbook No. 24. Blackwell Scientific Publications, Oxford. 367pp.
- Klumpp, D. W. (1984): Nutritional ecology of the ascidian, *Pyura stolonifera*: Influence of body size, food quantity and quality on filter feeding, respiration, assimilation efficiency and energy balance. *Marine Ecology Progress Series* 19(3): 269-284.
- Petersen, J. K., Schou, O. and Thor, P. (1995): Growth and energetics in the ascidian *Ciona intestinalis*. *Marine Ecology Progress Series* 120(1-3): 175-184.
- Schwinghamer, P., Hargrave, B., Peer, D. and Hawkins, C. M. (1986): Partitioning of production and respiration among size groups of organisms in an intertidal benthic community. *Marine Ecology Progress Series* 31: 131-142.
- Williams, P. J. leB. and Jenkinson, N. (1982): A transportable microprocessor controlled precise Winkler titration suitable for field station and shipboard use. *Limnology and Oceanography*, 27: 576-582.

#### PLATES / TABLE

PLATE I / TABLA I

Fig. 1: Fish farm in the Bay of Piran, Slovenia, showing positions of bio-filter arrays near fish cages (SL) and at location CL.

Sl. 1: Ribogojnica v Piranskem zalivu in postavitev nizov biofiltrov ob ribjih kletkah ter na lokaciji CL.

Fig. 2: Schematic presentation of one array showing position of bio-filters; four such arrays were deployed along fish cages and four at location CL.

Slika 2: Skica enega niza, ki kaže pozicijo biofiltrov; po štirje taki nizi so bili postavljeni vzdolž ribjih kletk in na lokaciji CL.

Fig. 3: Underwater slide of bio-filter array at Crete.

Slika 3: Podvodni posnetek niza biofiltrov na Kreti.

Figs. 4-6: Comparison of fouling communities developed on bio-filters near fish cages (a) and control locations (b) in Scotland (4 a,b, after one month of immersion), Israel (5a, b) and Slovenia (6a, b, after one month of immersion)

Slike 4-6: Primerjava združb obrasti na lokacijah v bližini ribjih kletk (a) in na kontrolnih lokacijah (b) na Škotskem (4a, b, en mesec po postavitvi biofiltrov), Izraelu (5a, b) in Sloveniji (6a, b, en mesec po postavitvi biofiltrov).

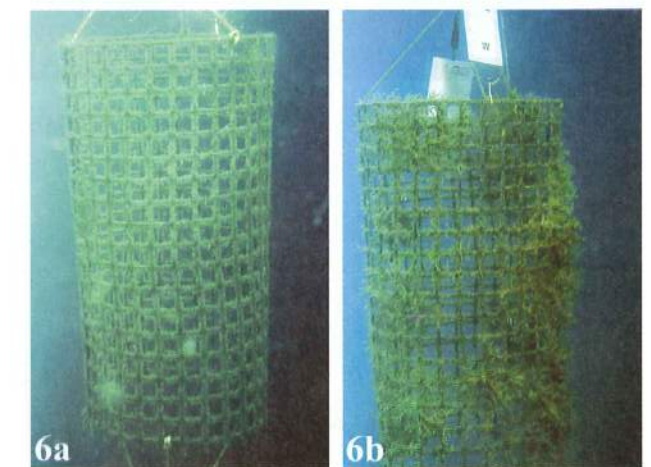
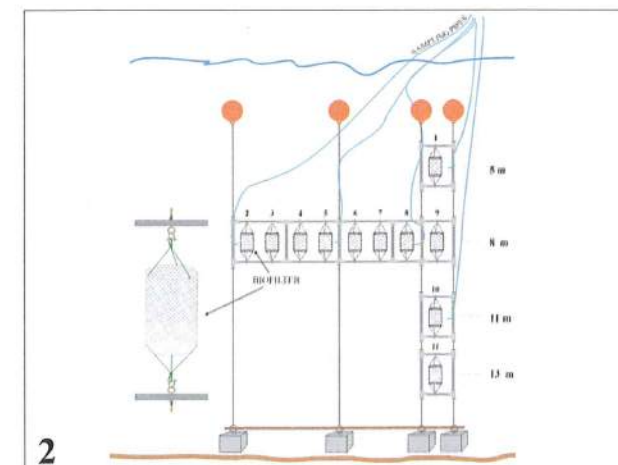
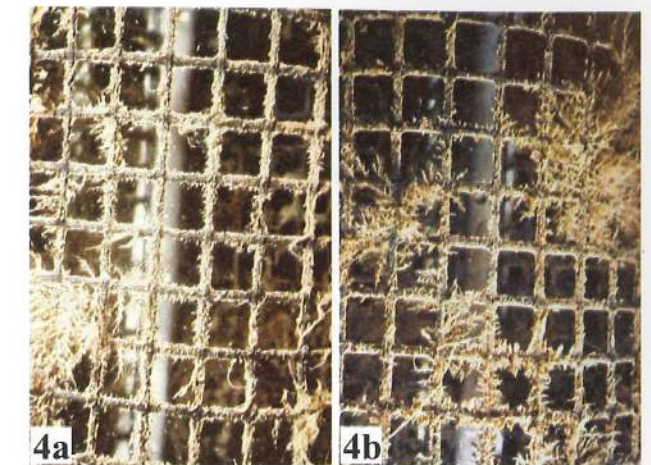



## PLATE II / TABLA II

Fig. 7: A variety of organisms on a bio-filter in site FF in Eilat (Israel, Red Sea): A tubular sponge, *Siphonochalina* sp.; a sea urchin *Diadema sestosum*; red sponges *Mycale fistulifera*; *Salmacina* sp. & *Josephella marenzelleri* polychaets.

Sl. 7: Na biofiltre na postaji FF v Eilatu (Rdeče morje, Izrael) se je naselila množica sesilnih organizmov: cevasta spužva *Siphonochalina* sp.; morski ježek *Diadema sestosum*; rdeča spužva *Mycale fistulifera*; cevkasti množčetinci *Salmacina* sp. in *Josephella marenzelleri*.

Fig. 8. Some stony coral *Stylophora pistilata* were also found among the epi-biota community on biofilters on both studied sites in Eilat (Red Sea).

Sl. 8: V združbi obrasti na biofiltrih na rdečemorskih postajah v Eilatu so se naselile tudi kamene korale *Stylophora pistilata*.

Fig. 9: A mussel line in Eilat (Red Sea) was completely overgrown with the red alga *Jania adhaerens* and a variety of sessile invertebrates such as red sponges *Mycale fistulifera*, encrusting bryozoans *Celleporaria aperta* and hydrozoans *Thyrosocyphus fruticosus*.

Sl. 9: Vrv za školjke v Eilatu (Rdeče morje) je bila popolnoma obrasla z rdečo algo *Jania adhaerens* in množico sesilnih nevretenčarjev kot so rdeča spužva *Mycale fistulifera*, skorjasti mahovnjaki *Celleporaria aperta* in trdoživnjaki *Thyrosocyphus fruticosus*.

Fig. 10: Underwater photo of the biofilter array in oligotrophic Mediterranean waters (Crete, Greece).

Slika 10: Podvodni posnetek niza biofiltriv v oligotrofnih sredozemskih vodah (Kreta, Grčija).

Fig. 11: The significant increase in biomass, particularly in the first 4 months after deployment was primarily due to an increase in the biomass of the ascidian, *Asciidiella aspersa*, at both studies sites off West Scotland.

Sl. 11: Plaščar *Asciidiella aspersa* je največ prispeval k znatnem porastu biomase na obeh postajah ob zahodni Škotski, še posebej v prvih štirih mesecih po postavitvi biofiltriv.

Fig. 12: The rapidly colonising epibiota community on the biofilters at the Piran station (Slovenia) provided a variety of shelters for different fish species such as *Symphodus tinca*.

Sl. 12: Združba obrasti, ki se hitro naseli na biofiltrih, nudi številne niše za različne vrste niš, med drugim tudi za ustnačo *Symphodus tinca*.

Fig. 13: Plaščar *Polycarpa pomaria* colonized biofilters at the station near fish farm in the Bay of Piran (Slovenia).

Sl. 13: The ascidian *Polycarpa pomaria* se je naselil na biofiltre na postaji ob ribogojnici v Piranskem zalivu (Slovenija).

Fig. 14: Underwater photo of the biofilter incubation chambers (mesocosm) in the Bay of Piran, Slovenia (see Fig. 1 in Turk & Malej, this volume, for schematic presentation of experimental system).

Sl. 14: Podvodni posnetek inkubacijskih posod v Piranskem zalivu, Slovenija (Shema poskusnega sistema je predstavljena na sliki 1, v prispevku Turk & Malej, ta volumen).

